

MSB

SCISSORS



Micro Scissors

Mikro-Scheren
 Micro Forbici
 Micro Tijeras
 Micro Ciseaux

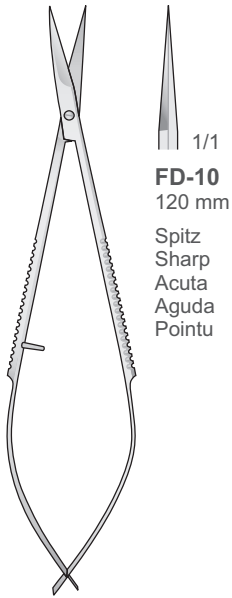

1/1
FD-10
 120 mm
 Spitz
 Sharp
 Acuta
 Aguda
 Pointu

NOYES
FD-10
 120 mm

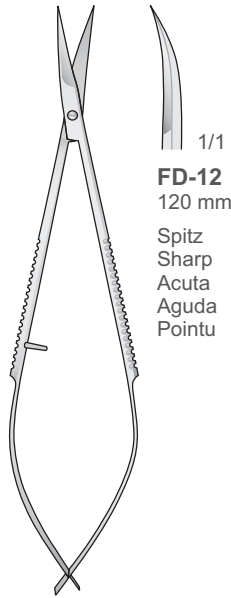

1/1
FD-12
 120 mm
 Spitz
 Sharp
 Acuta
 Aguda
 Pointu

NOYES
FD-12
 120 mm

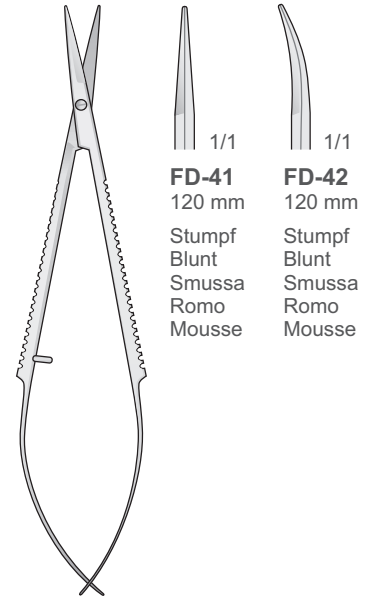

1/1 1/1
FD-41 **FD-42**
 120 mm 120 mm
 Stumpf
 Blunt
 Smussa
 Romo
 Mousse

FD-41/FD-42
 120 mm

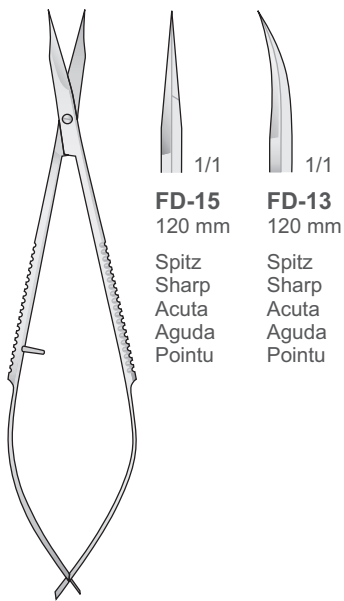

1/1 1/1
FD-15 **FD-13**
 120 mm 120 mm
 Spitz
 Sharp
 Acuta
 Aguda
 Pointu

WESTCOTT
FD-13/FD-15
 120 mm

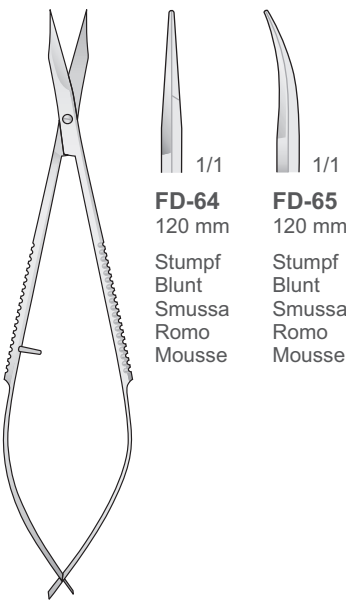

1/1 1/1
FD-64 **FD-65**
 120 mm 120 mm
 Stumpf
 Blunt
 Smussa
 Romo
 Mousse

WESTCOTT
FD-64/FD-65
 120 mm

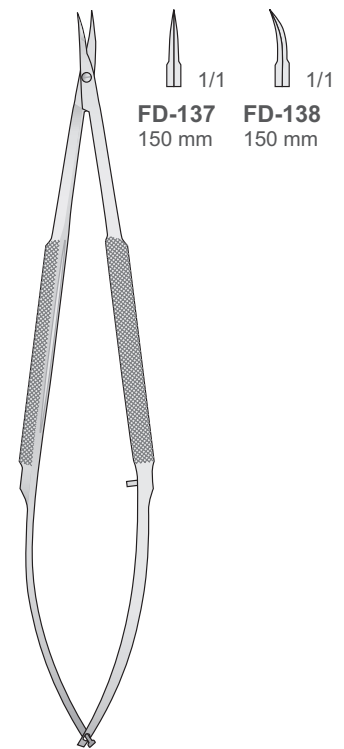

1/1 1/1
FD-137 **FD-138**
 150 mm 150 mm

FD-137/FD-138
 150 mm

Scissors

Scheren
Forbici
Tijeras
Ciseaux

Scissors

Scheren
Forbici
Tijeras
Ciseaux

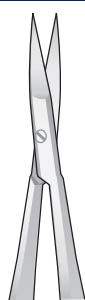
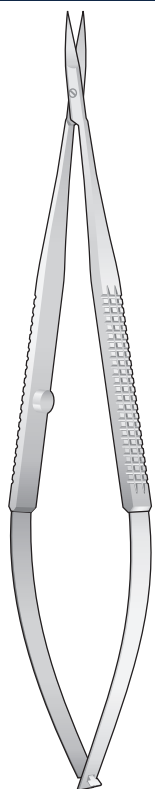

FD-182
160 mm
Spitz
Sharp
Acuta
Aguda
Pointu

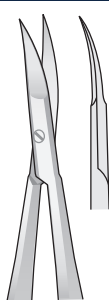

FD-183
160 mm
Spitz
Sharp
Acuta
Aguda
Pointu

1/1

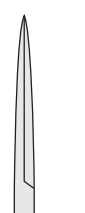
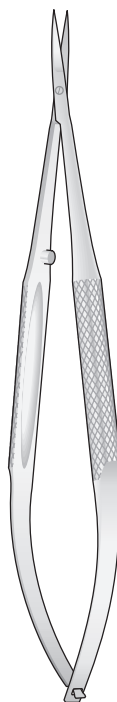

FD-224
145 mm
Spitz
Sharp
Acuta
Aguda
Pointu

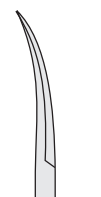

FD-225
145 mm
Spitz
Sharp
Acuta
Aguda
Pointu

1/1

1/1

FD-182/FD-183
160 mm

FD-224/FD-225
145 mm

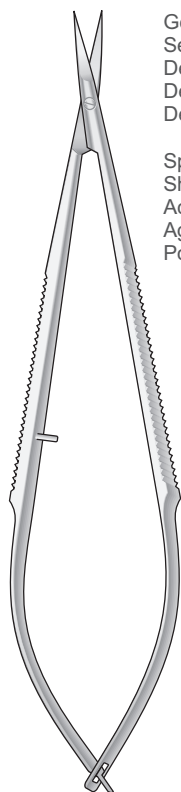

Gezahnt
Serrated
Dentellata
Dentada
Dentelé

Spitz
Sharp
Acuta
Aguda
Pointu

FD-145
160 mm

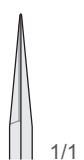
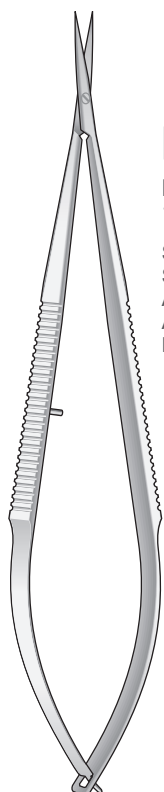

FD-06
160 mm
Spitz
Sharp
Acuta
Aguda
Pointu

1/1

FD-06
160 mm

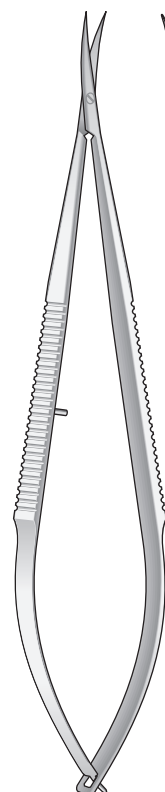

FD-08
160 mm
Spitz
Sharp
Acuta
Aguda
Pointu

1/1

FD-08
160 mm

Scissors

Scheren
Forbici
Tijeras
Ciseaux

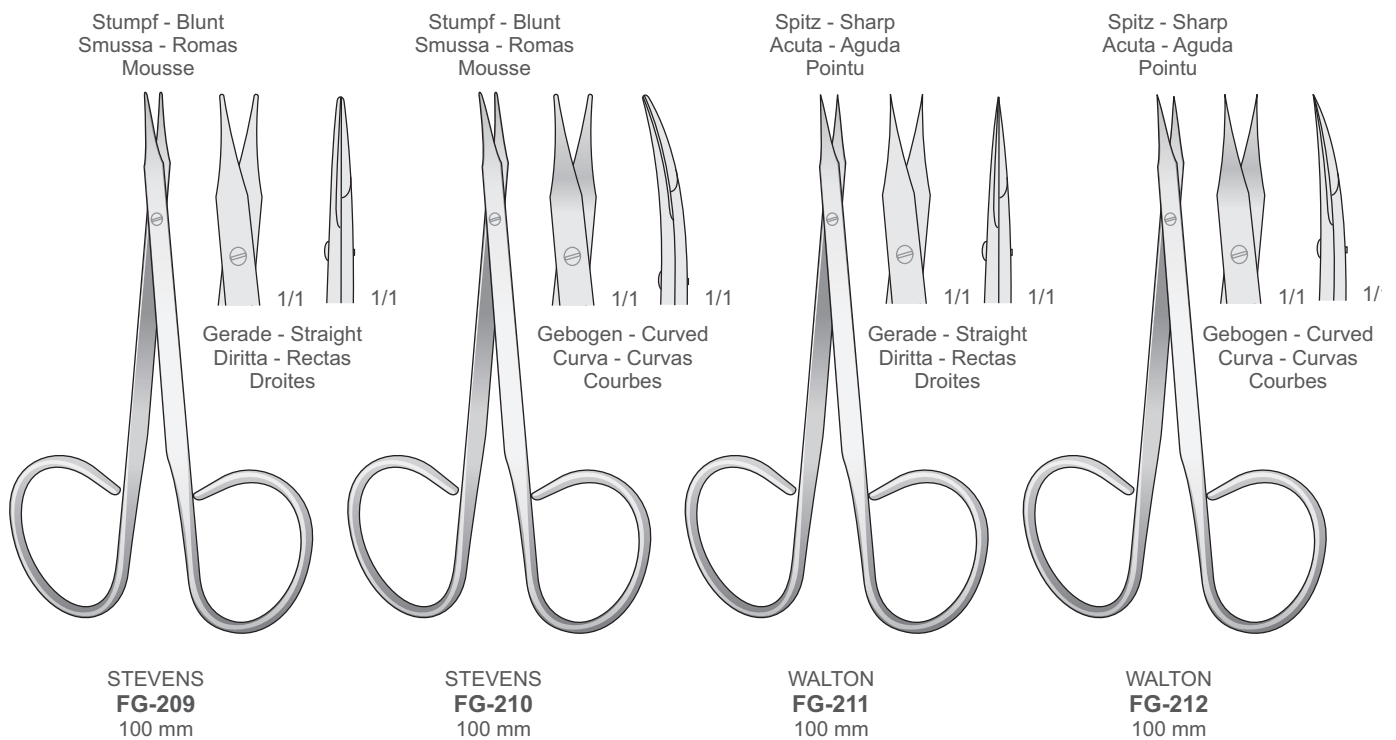
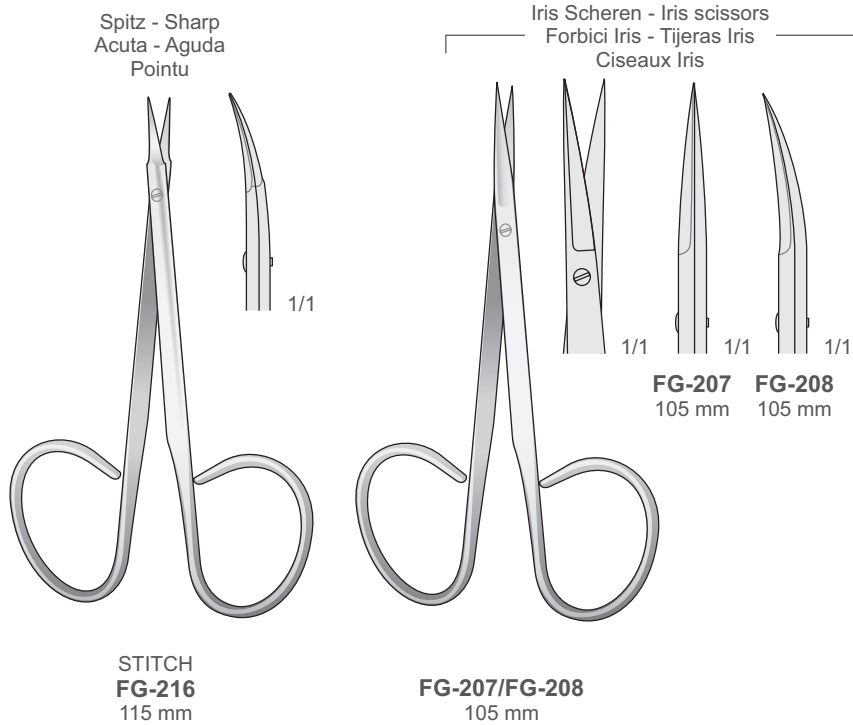

Scissors

Scheren
Forbici
Tijeras
Ciseaux

Scissors

Scheren
Forbici
Tijeras
Ciseaux

L = links
left
mancini
izquierdo
gauche

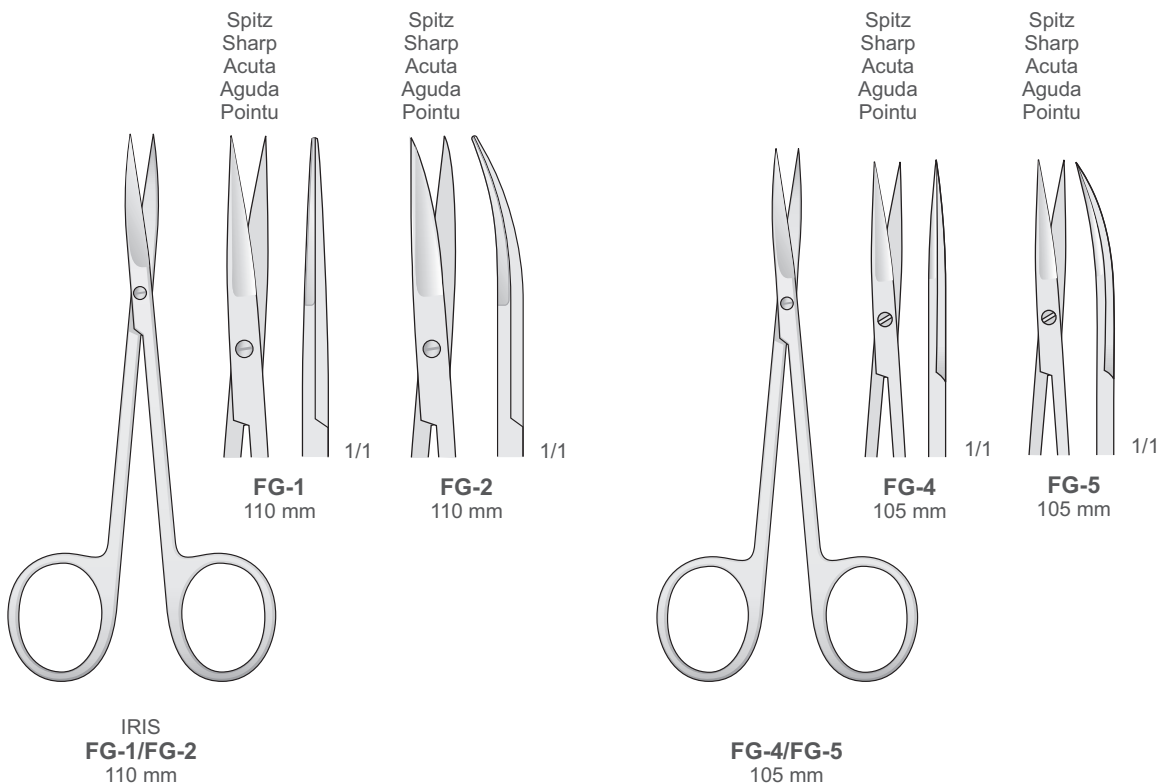
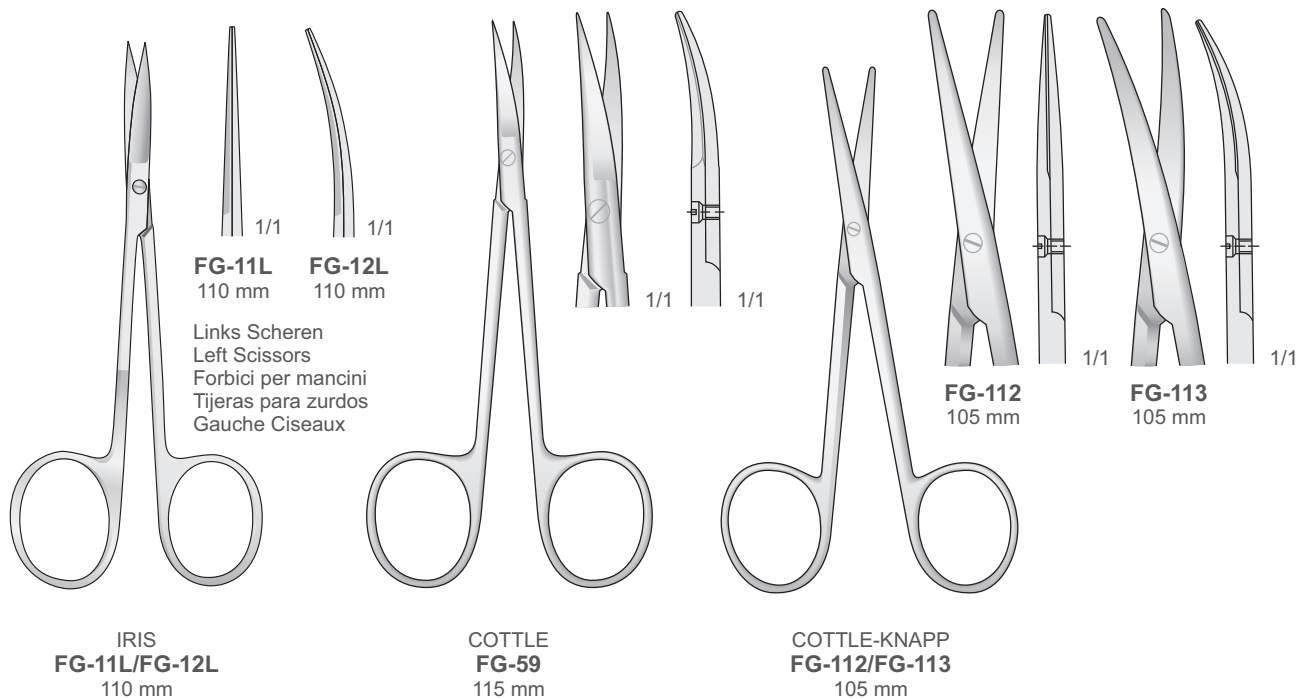

Scissors

Scheren
Forbici
Tijeras
Ciseaux

Gezahnt - Serrated
Dentellata - Dentelé - Dentadas

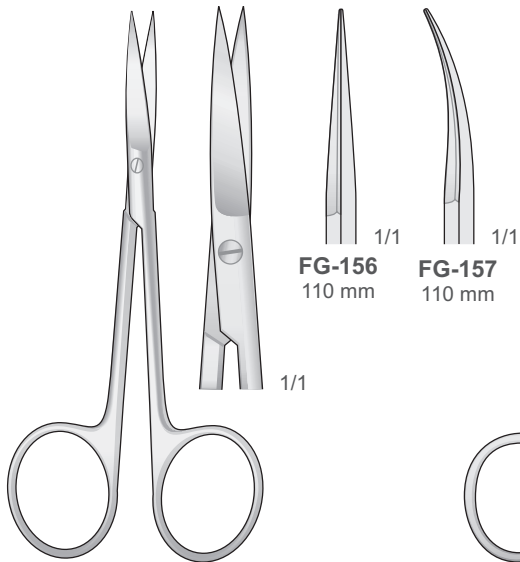

FG-156/FG-157
110 mm

Gezahnt - Serrated
Dentellata - Dentelé - Dentadas

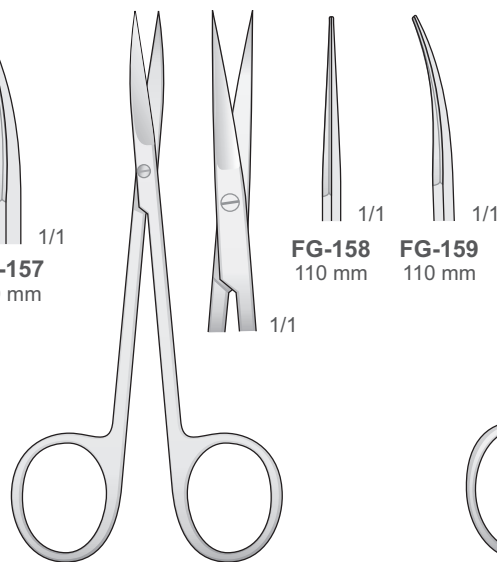

FG-158/FG-159
110 mm

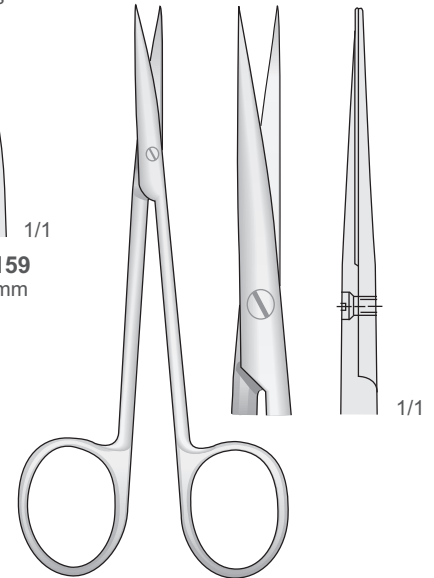

**KILNER
FG-58**
115 mm

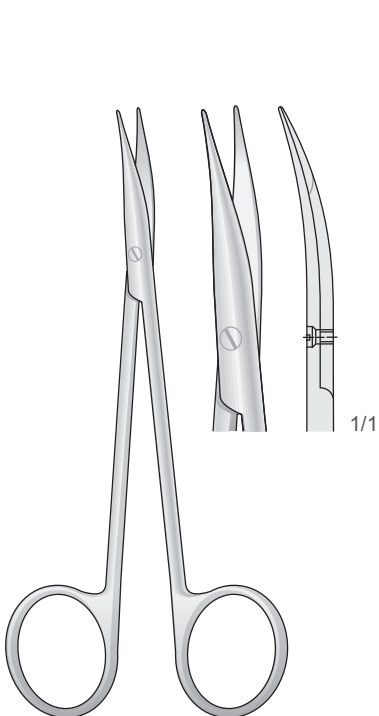

**JAMESON-WERBER
FG-123**
130 mm

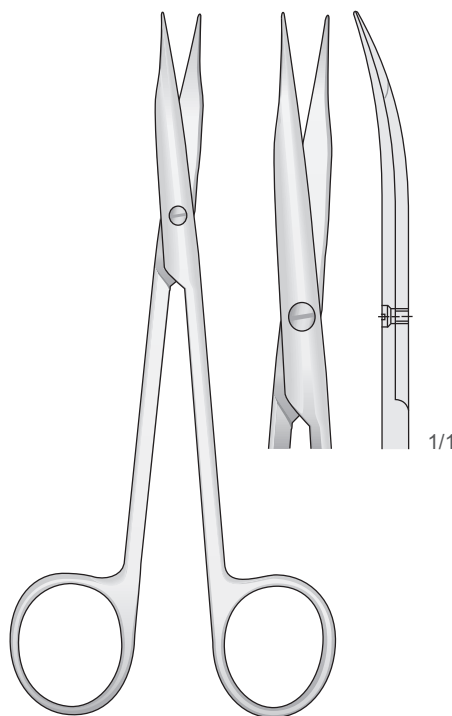

**JAMESON
FG-124**
145 mm

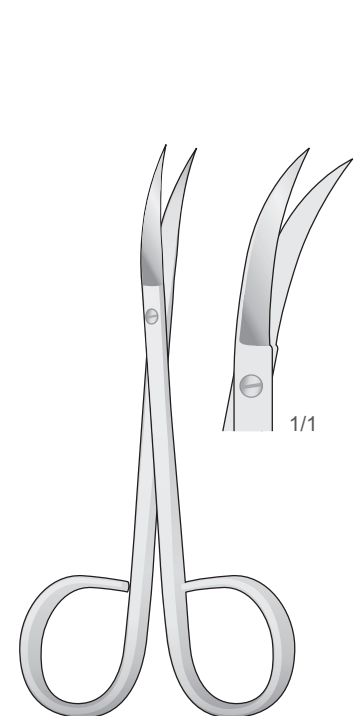

FG-3
115 mm

Scissors

Scheren
Forbici
Tijeras
Ciseaux

Scissors

Scheren
Forbici
Tijeras
Ciseaux

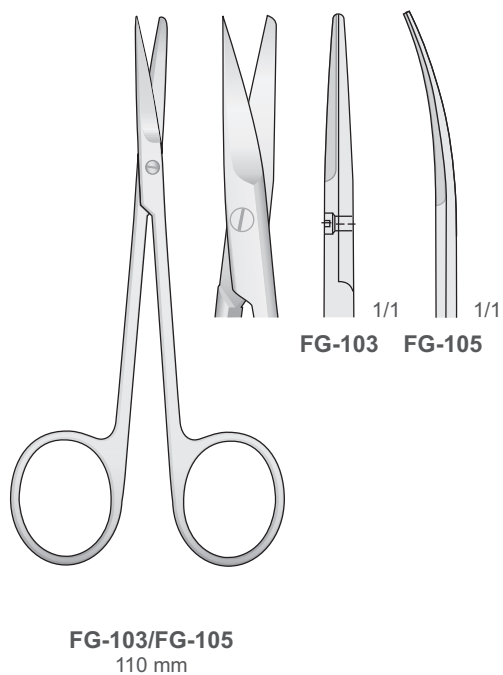
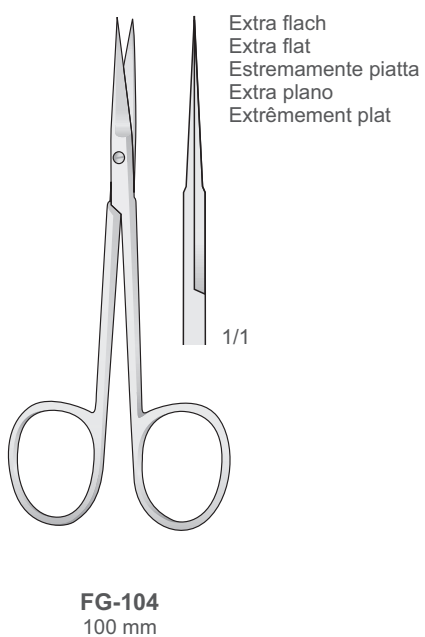
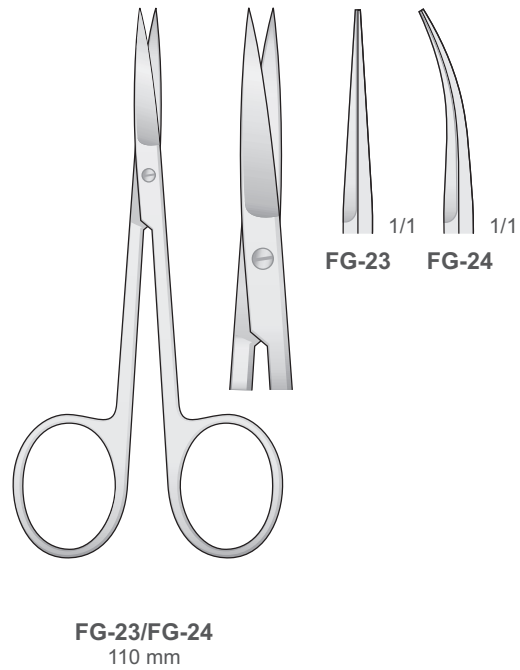
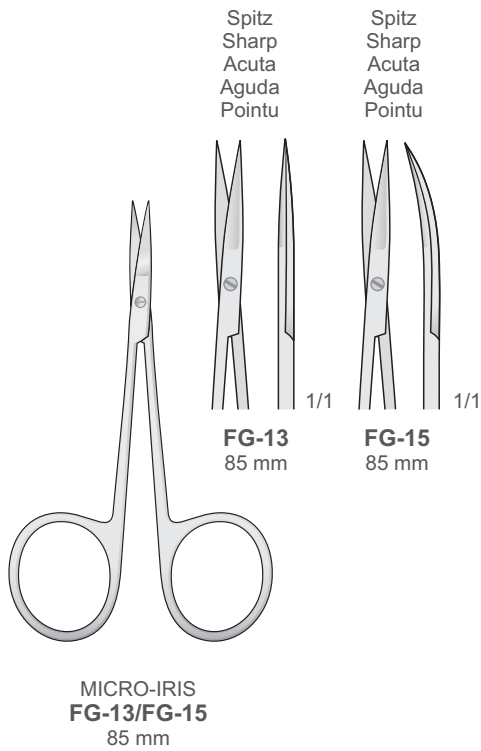

Scissors

Scheren
Forbici
Tijeras
Ciseaux

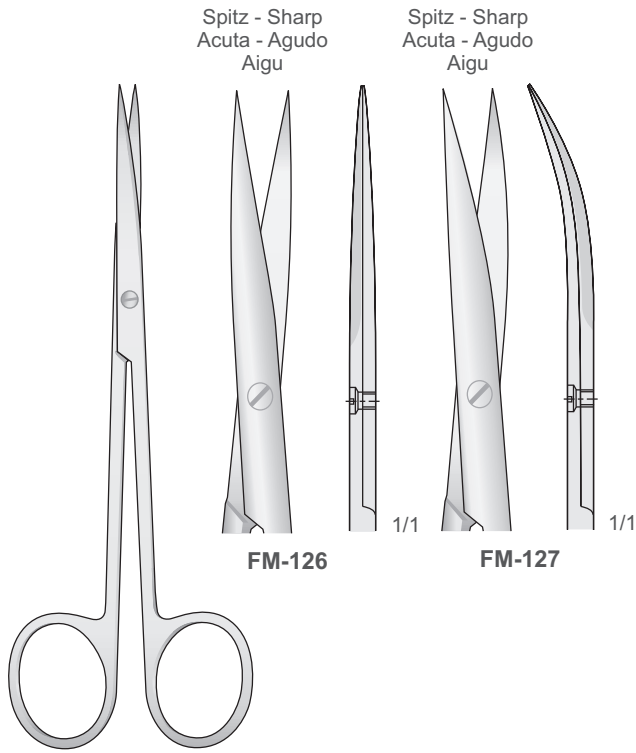

METZENBAUM
FM-126/FM-127
145 mm

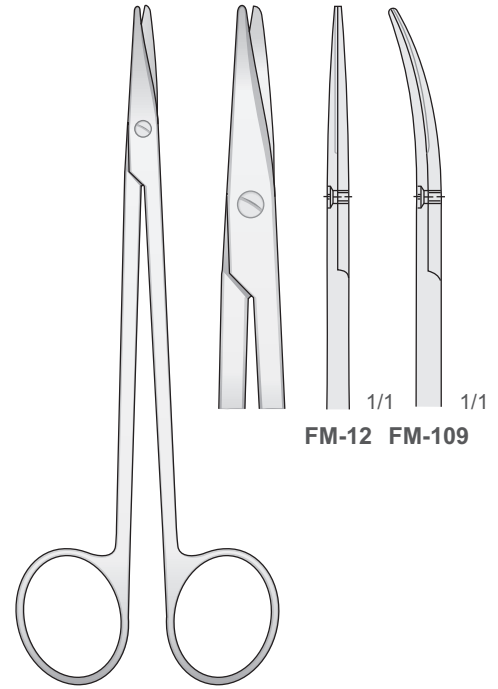

METZENBAUM
FM-12/FM-109
150 mm

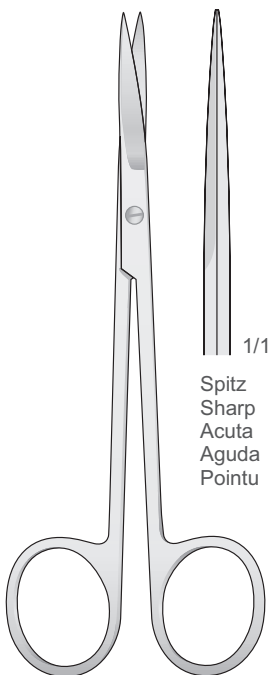

METZENBAUM
FG-28
145 mm

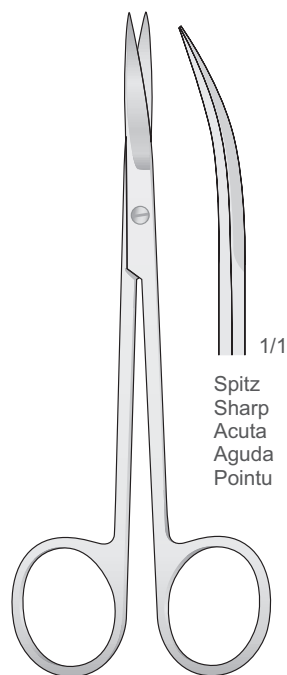

METZENBAUM
FG-14
145 mm

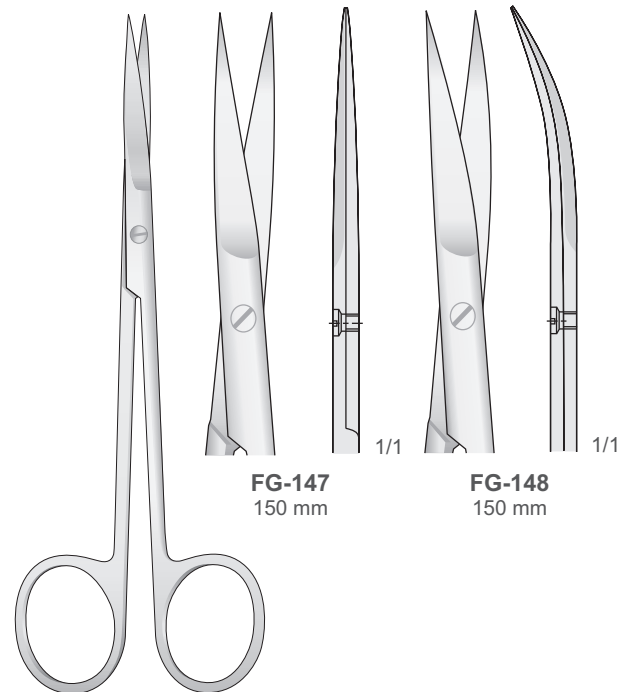

JOSEPH
FG-147/FG-148
150 mm

Scissors

Scheren
Forbici
Tijeras
Ciseaux

Scissors

Scheren
Forbici
Tijeras
Ciseaux

Stumpf
Blunt
Smussa
Romas
Mousse

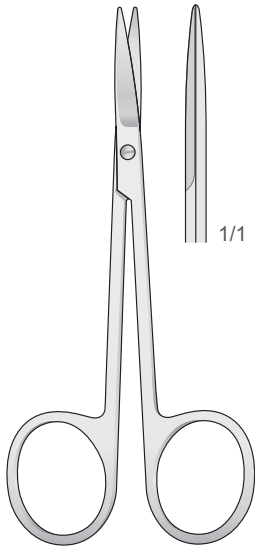

FG-101
110 mm

Stumpf
Blunt
Smussa
Romas
Mousse

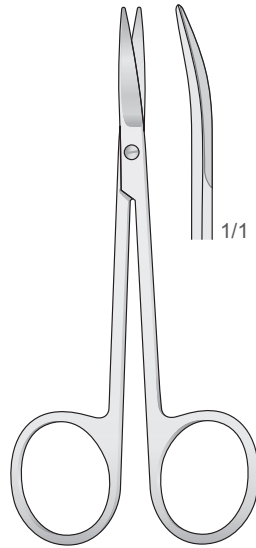

FG-102
110 mm

Stumpf
Blunt
Smussa
Romas
Mousse

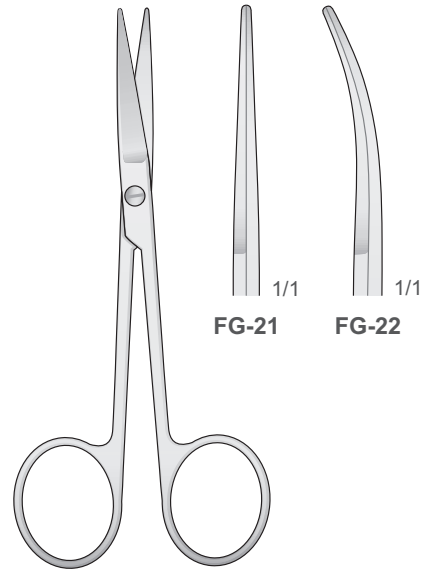

FG-21/FG-22
115 mm

Spitz
Sharp
Acute
Agudas
Pointu

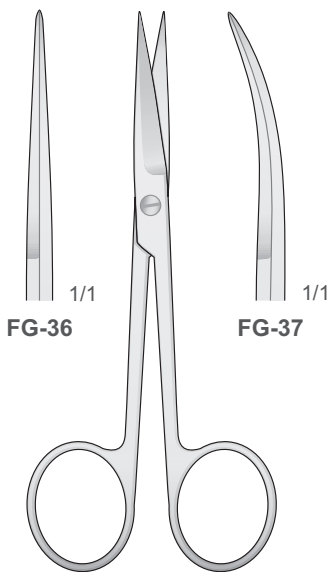

FG-36/FG-37
115 mm

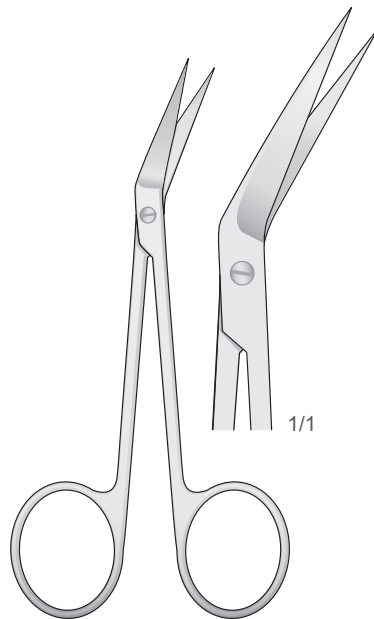

LOCKLIN
LK-1
115 mm

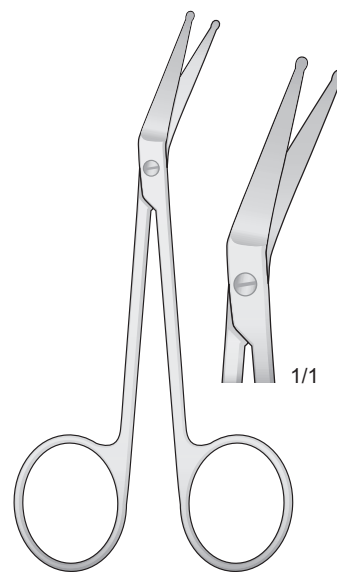

LOCKLIN MOD.
LK-3
110 mm

Scissors

Scheren
Forbici
Tijeras
Ciseaux

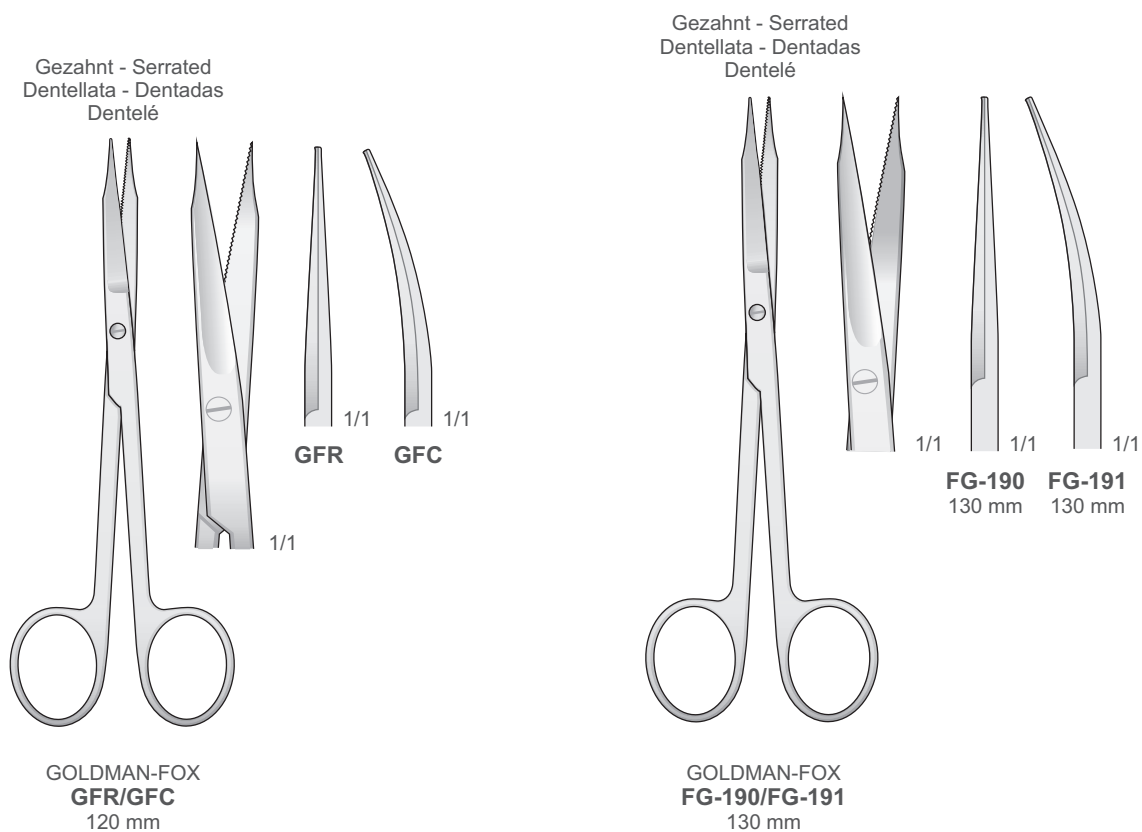
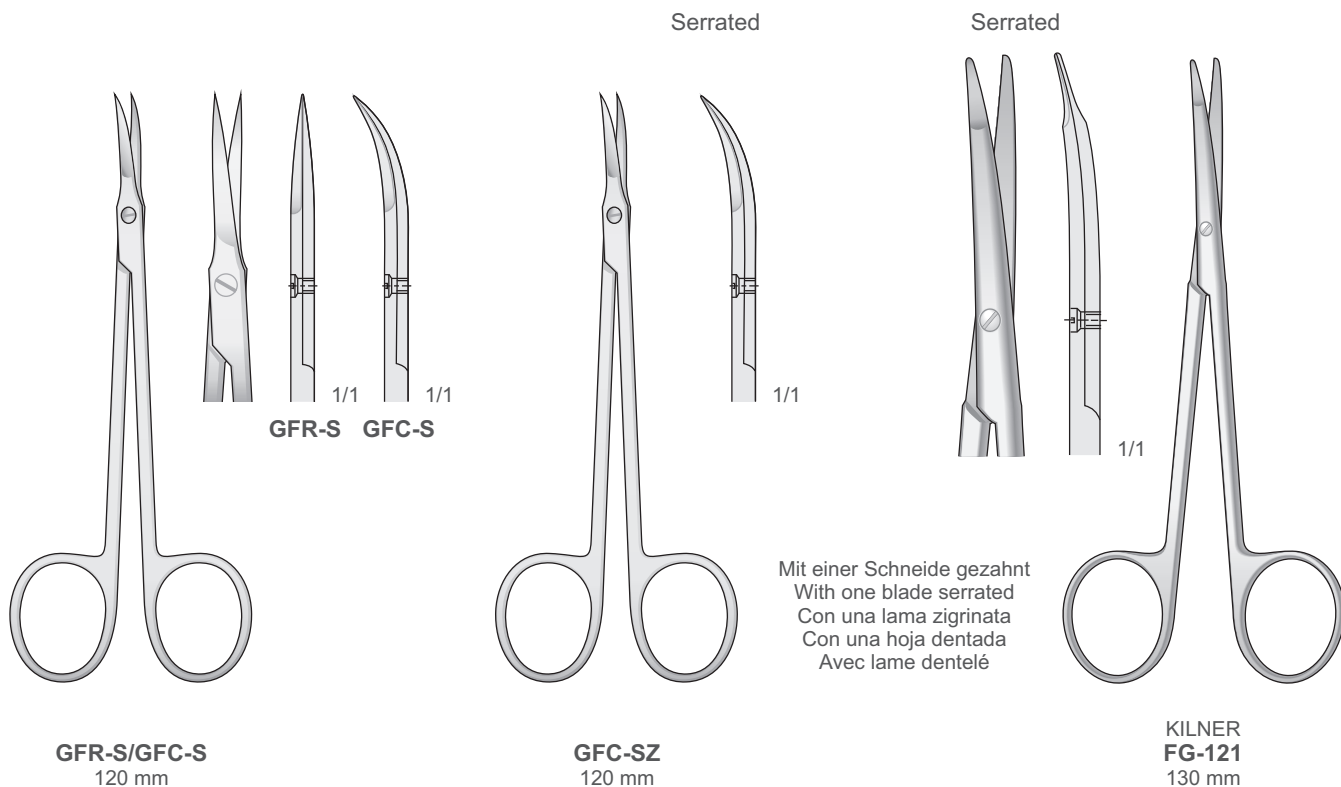

Scissors

Scheren
Forbici
Tijeras
Ciseaux

Scissors

Scheren
Forbici
Tijeras
Ciseaux

Gezahnt - Serrated
Dentellata - Dentadas
Dentelé

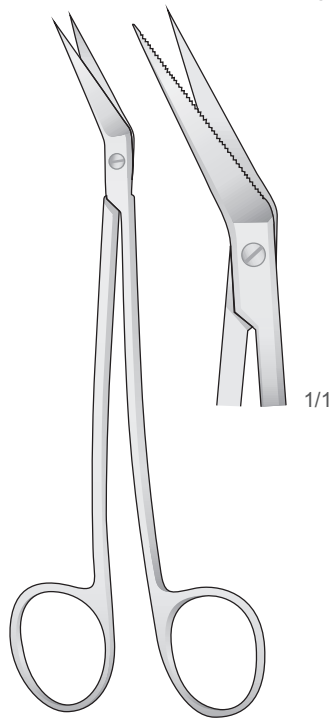

LOCKLIN
LK-2
160 mm

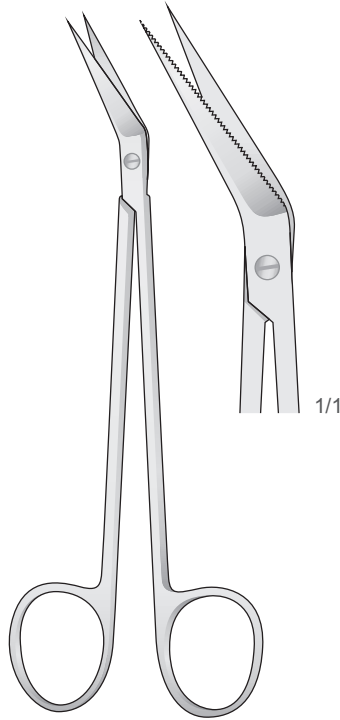

LOCKLIN
LK-4
160 mm

Gezahnt - Serrated
Dentellata - Dentadas
Dentelé

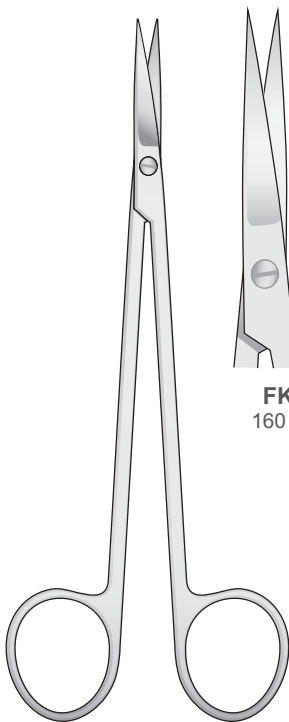

KELLY
FK-1/FK-2
160 mm

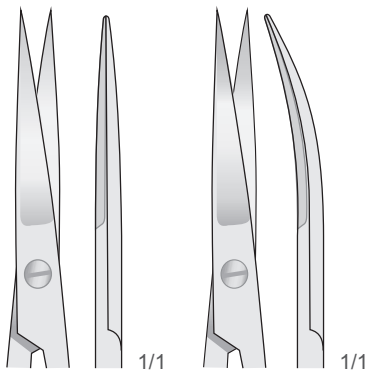

FK-1
160 mm

FK-2
160 mm

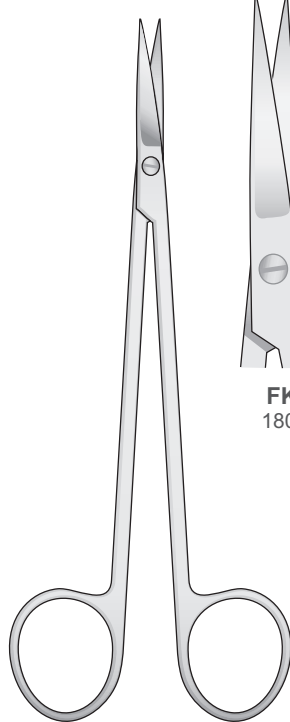

KELLY
FK-87/FK-88
180 mm

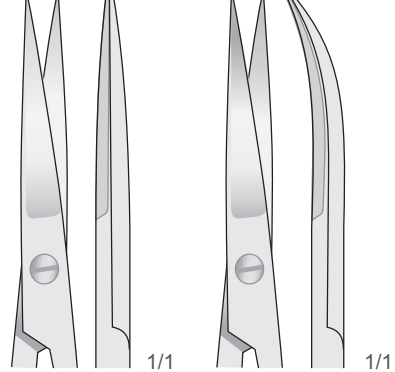

FK-87
180 mm

FK-88
180 mm

Scissors

Scheren
Forbici
Tijeras
Ciseaux

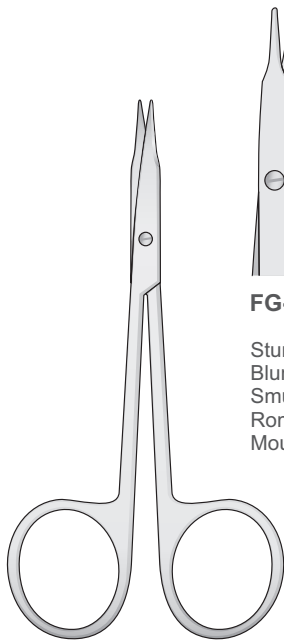

STEVENS
FG-50/FG-53
110 mm

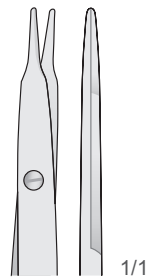

FG-50

Stumpf
Blunt
Smussa
Romas
Mousse

Gerade
Straight
Diritta
Rectas
Droites

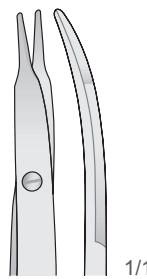

FG-51

Stumpf
Blunt
Smussa
Romas
Mousse

Gebogen
Curved
Curva
Curvas
Courbes

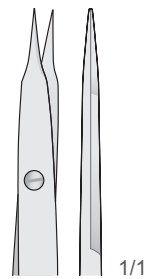

FG-52

Spitz
Sharp
Acuta
Agudas
Pointu

Gerade
Straight
Diritta
Rectas
Droites

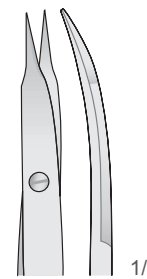

FG-53

Spitz
Sharp
Acuta
Agudas
Pointu

Gebogen
Curved
Curva
Curvas
Courbes

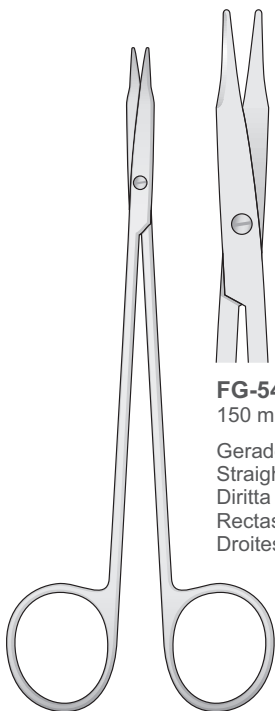

REYNOLDS
FG-54/FG-55

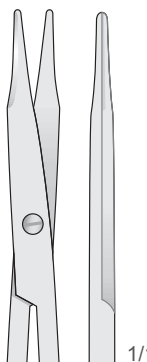

FG-54
150 mm

Gerade
Straight
Diritta
Rectas
Droites

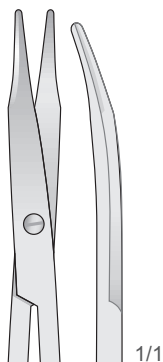

FG-55
150 mm

Gebogen
Curved
Curva
Curvas
Courbes

Stumpf
Blunt
Smussa
Romas
Mousse

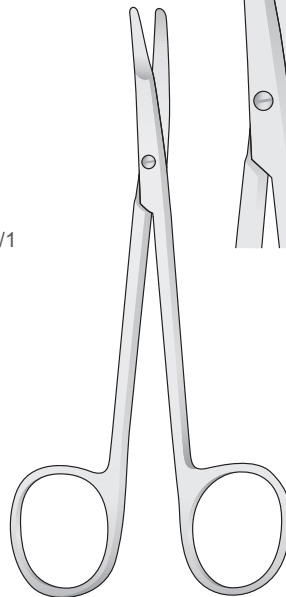

KILNER
FG-19C/FG-67

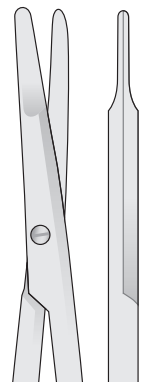

FG-66
120 mm

Gerade
Straight
Diritta
Rectas
Droites

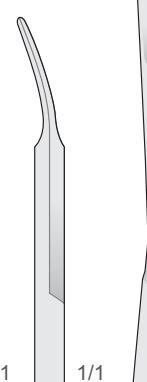

FG-67
120 mm

Gebogen
Curved
Curva
Curvas
Courbes

Stumpf
Blunt
Smussa
Romas
Mousse

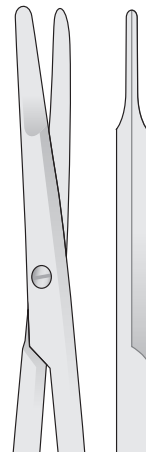

FG-19R
135 mm

Gerade
Straight
Diritta
Rectas
Droites

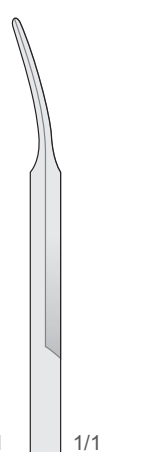

FG-19C
135 mm

Gebogen
Curved
Curva
Curvas
Courbes

Scissors

Scheren
Forbici
Tijeras
Ciseaux

Scissors

Scheren
Forbici
Tijeras
Ciseaux

Gezahnt - Serrated
Dentellata - Dentadas
Dentelé

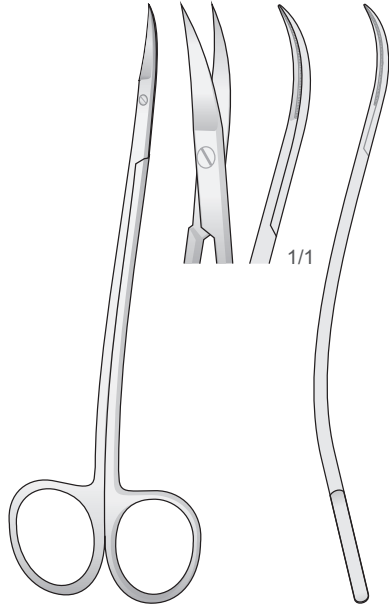

LA GRANGE
LG-1
115 mm

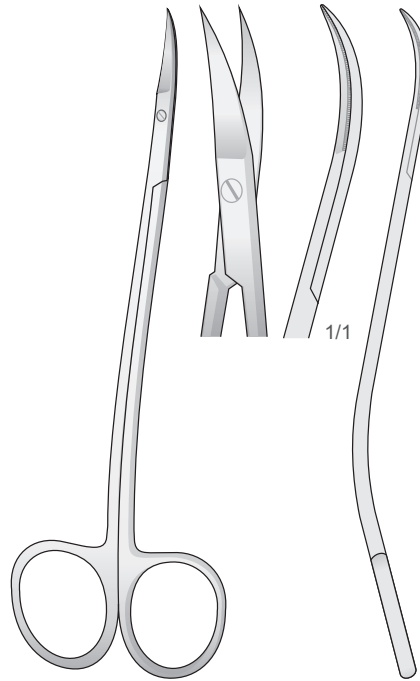

LA GRANGE
LG-6
155 mm

Gezahnt - Serrated
Dentellata - Dentada
Dentée

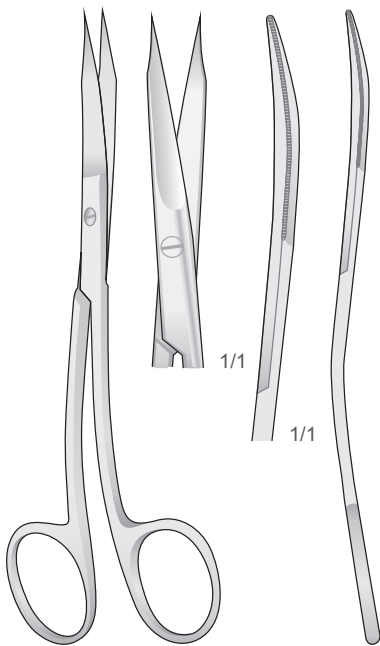

GOLDMAN-FOX S FORM
GFS
130 mm

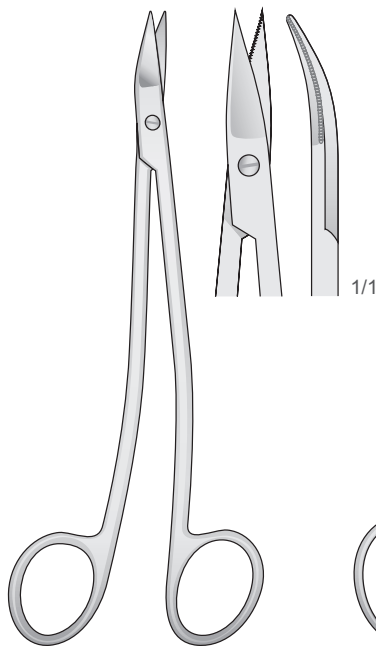

NEUMANN
FG-20
130 mm

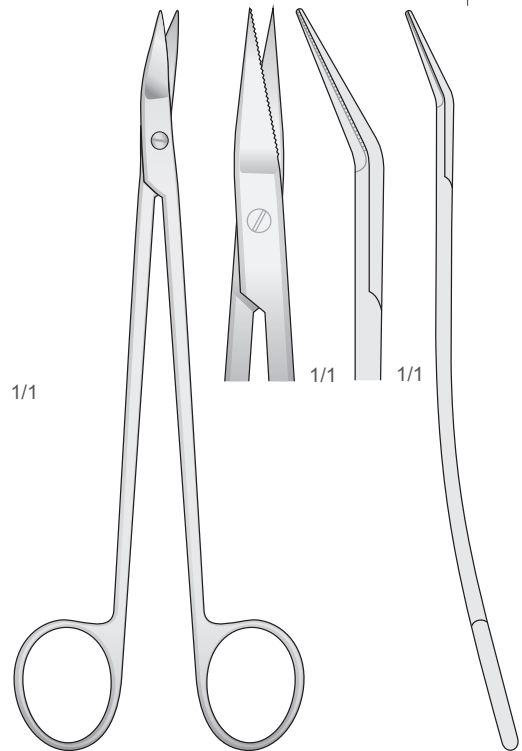

DEAN
DEAN
180 mm

Scissors

Scheren
Forbici
Tijeras
Ciseaux

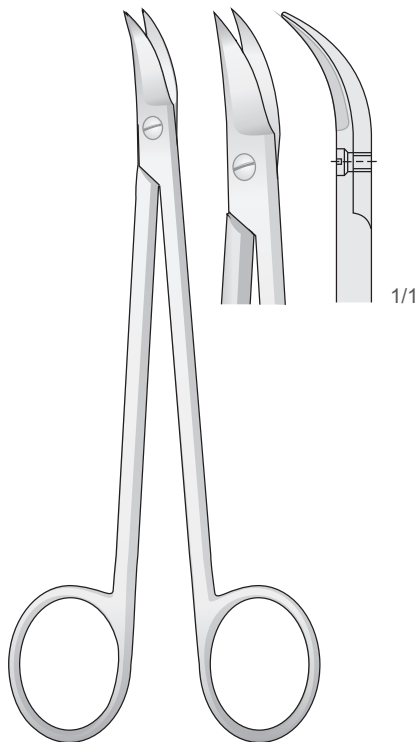

QUINBY
FG-38
130 mm

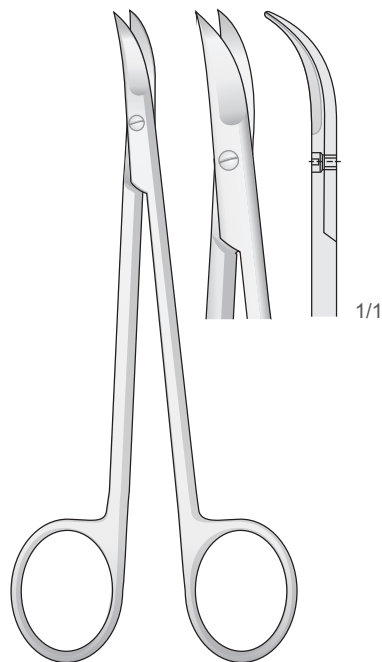

CHADWICK
FG-39
115 mm

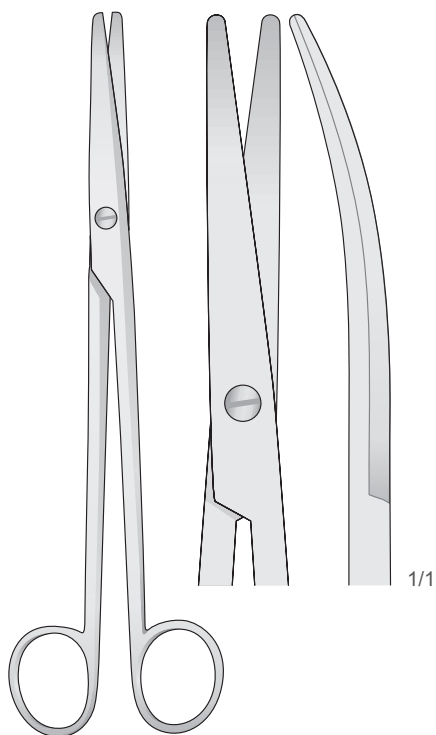

MAYO-LEXER
FM-79
165 mm

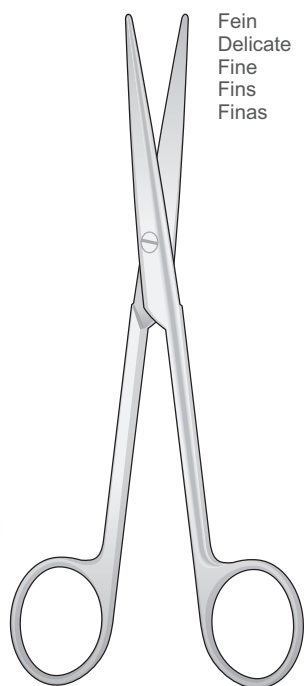

LEXER
FM-180/FM-181
165 mm

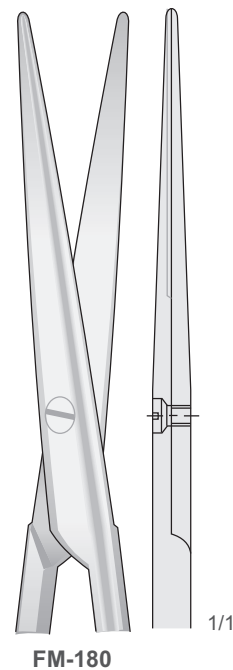

FM-180

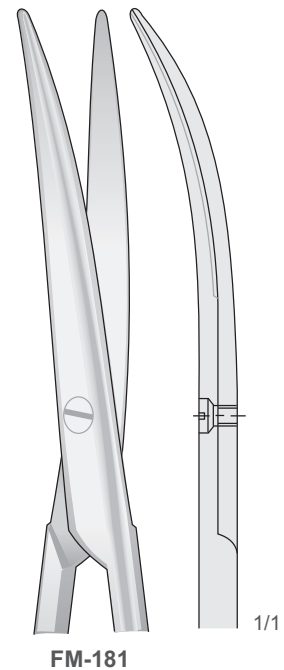

FM-181

Fein
Delicate
Fine
Fins
Finas

Scissors

Scheren
Forbici
Tijeras
Ciseaux

Scissors

Scheren
Forbici
Tijeras
Ciseaux

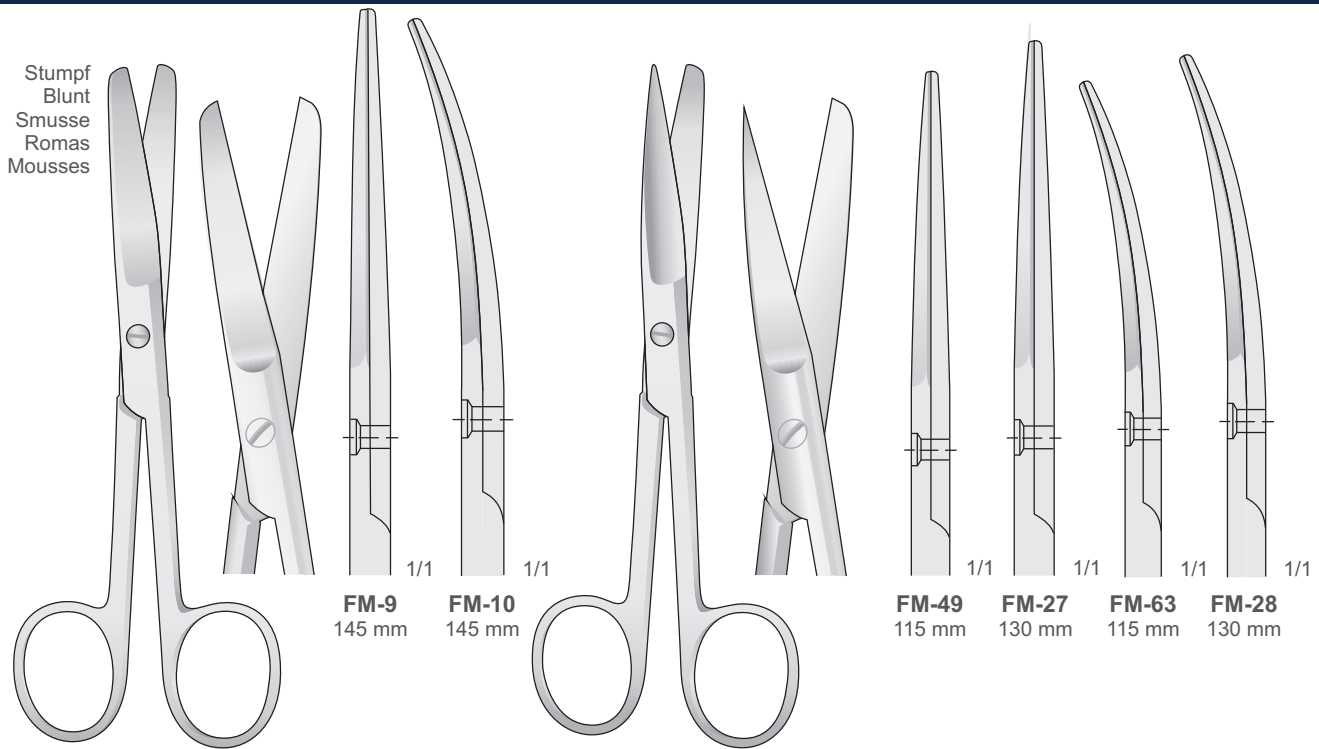

Stumpf
Blunt
Smusse
Romas
Mousses

FM-9
145 mm

FM-10
145 mm

FM-49
115 mm

FM-27
130 mm

FM-63
115 mm

FM-28
130 mm

FM-9/FM-10
145 mm

FM-27/FM-63

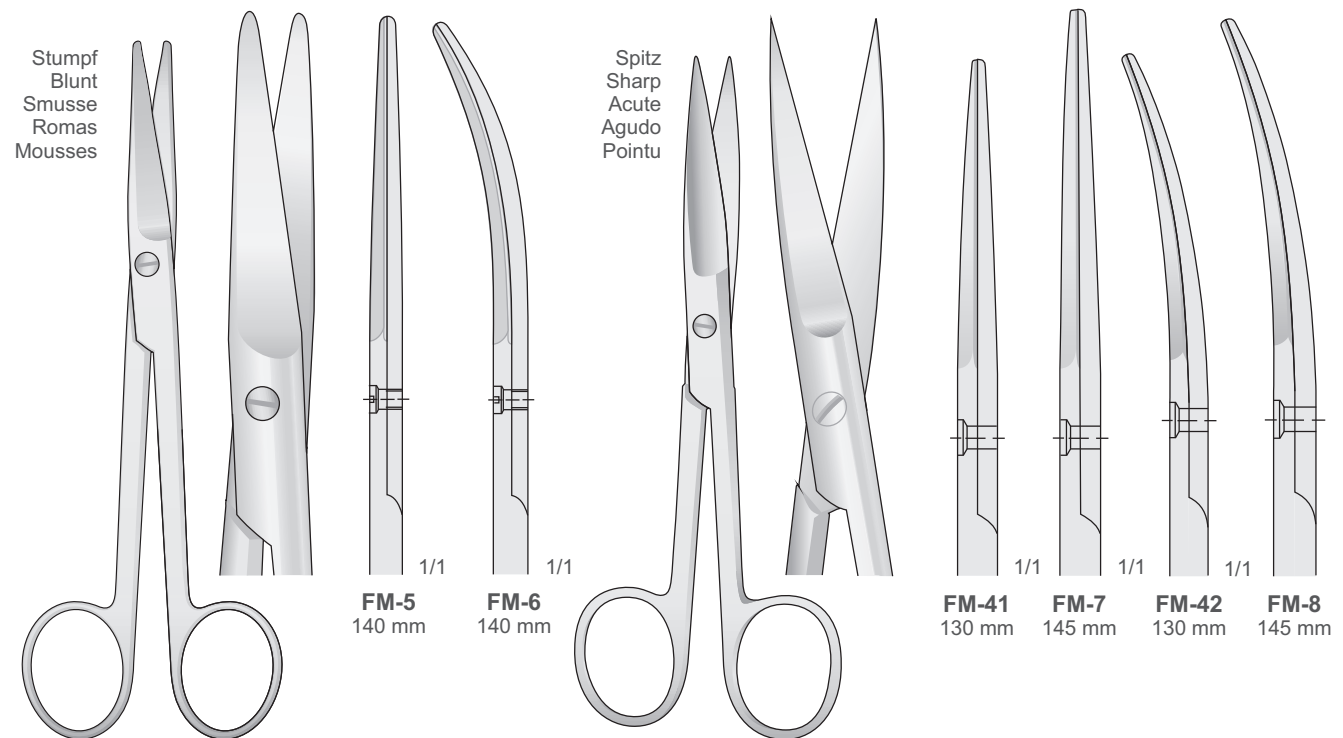

Stumpf
Blunt
Smusse
Romas
Mousses

Spitz
Sharp
Acute
Agudo
Pointu

FM-5
140 mm

FM-6
140 mm

FM-41
130 mm

FM-7
145 mm

FM-42
130 mm

FM-8
145 mm

MAYO
FM-5/FM-6
140 mm

FM-7/FM-42

Scissors

Scheren
Forbici
Tijeras
Ciseaux

SUPER CUT



Regular Edge **SUPER CUT Edge**

Super Cut Scissors have specially designed cutting edges. One regular edge and **one sharp-knife edge.**

 **Extremely Sharp Razor Edge / Atraumatic**
Extrem Scharfe Spitzer Beck / Atraumatische
Tranchant extrêmement aiguisée / Atraumatische
Borde extremadamente afilado / Atraumática
Taglio estremamente affilato / Atraumatica

 **One side serrated**
Eine seite gezahnt
Un côté dentelé
Un lado dentado
Un lato dentellato

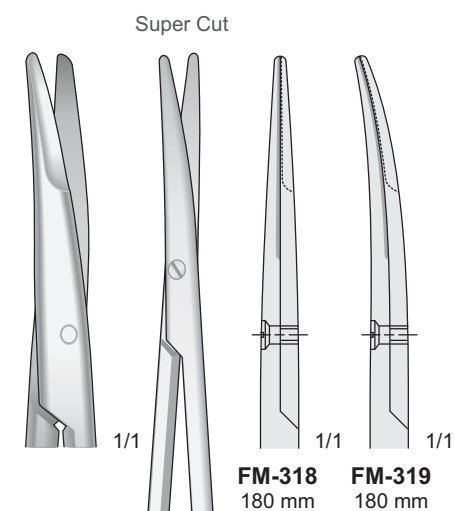

METZENBAUM
FM-318/FM-319
180 mm

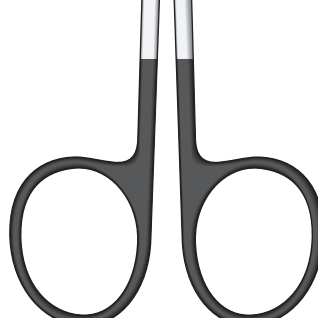
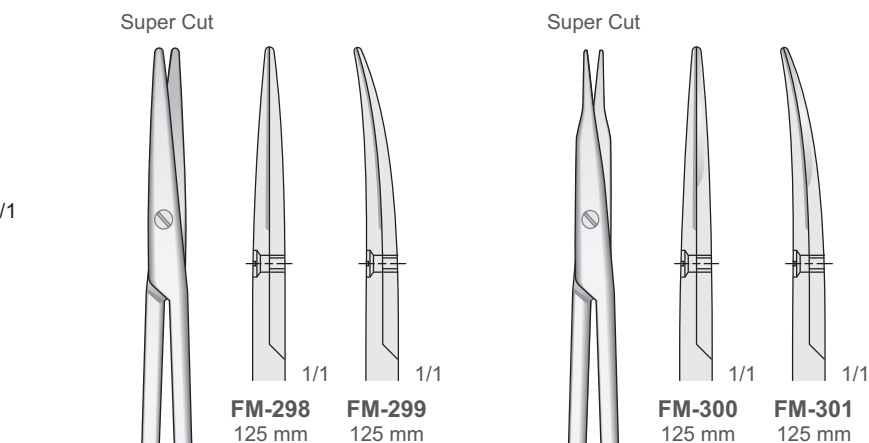

METZENBAUM
FM-298/FM-299
125 mm

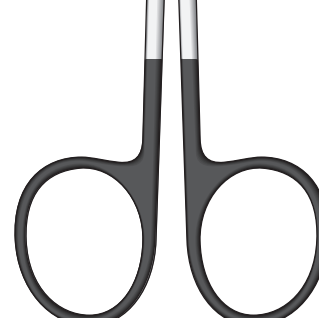

STEVENS
FM-300/FM-301
125 mm

Scissors

Scheren
Forbici
Tijeras
Ciseaux

Scissors

Scheren
Forbici
Tijeras
Ciseaux

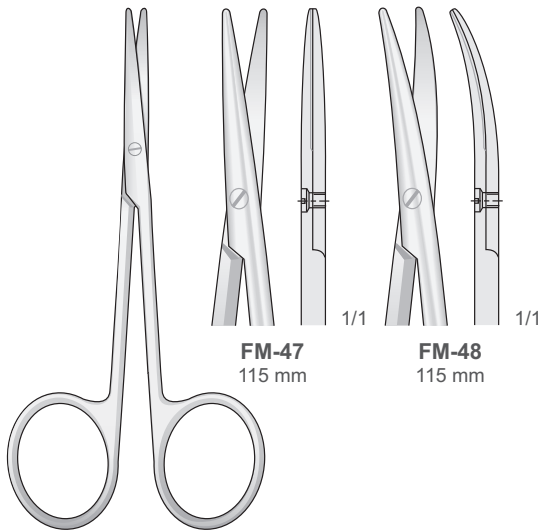

FM-47
115 mm

FM-48
115 mm

BABY - METZENBAUM
FM-47/FM-48
115 mm

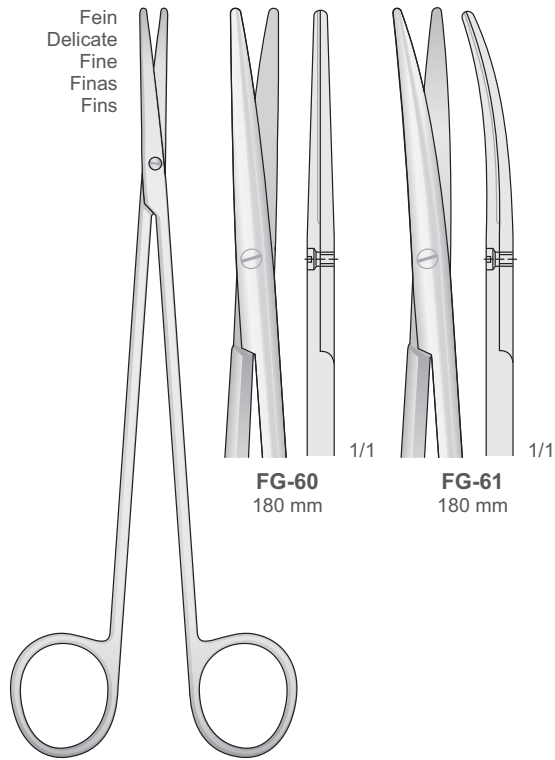

FG-60
180 mm

FG-61
180 mm

TOENNIS-ADSON
FG-60/FG-61
180 mm

Präparierscheren - Dissecting Scissors
Forbici per dissezione - Tijeras de dissección - Ciseaux à dissection

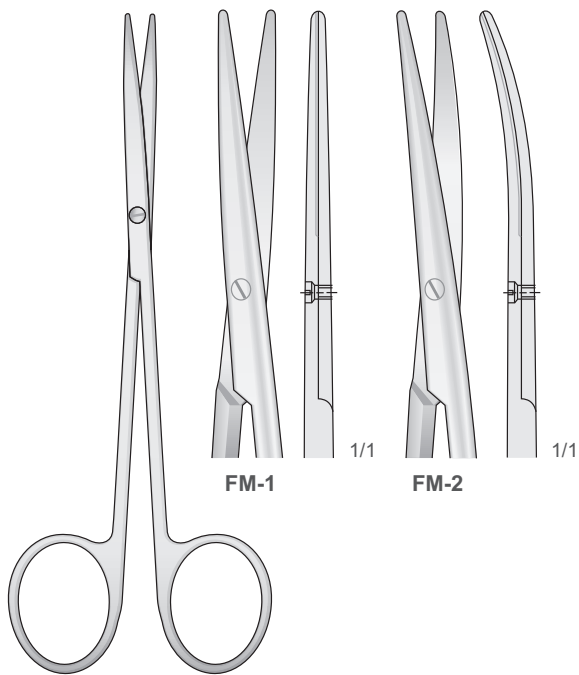

FM-1

FM-2

METZENBAUM
FM-1/FM-2
145 mm

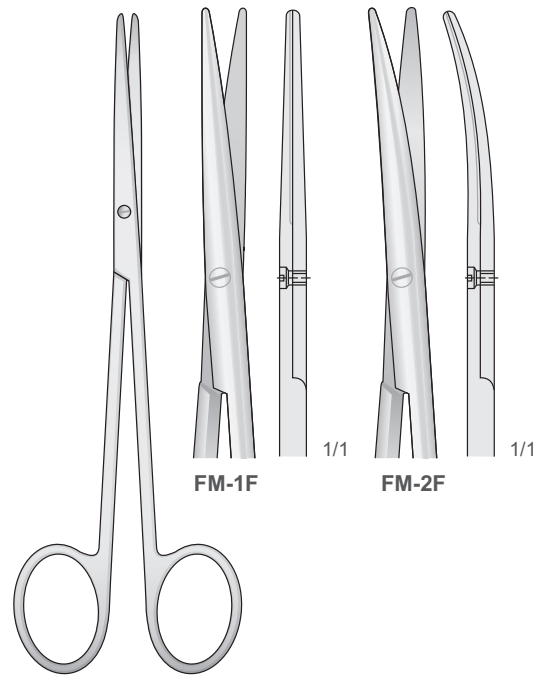

FM-1F

FM-2F

METZENBAUM-FINO
FM-1F/FM-2F
145 mm

Scissors

Scheren
Forbici
Tijeras
Ciseaux

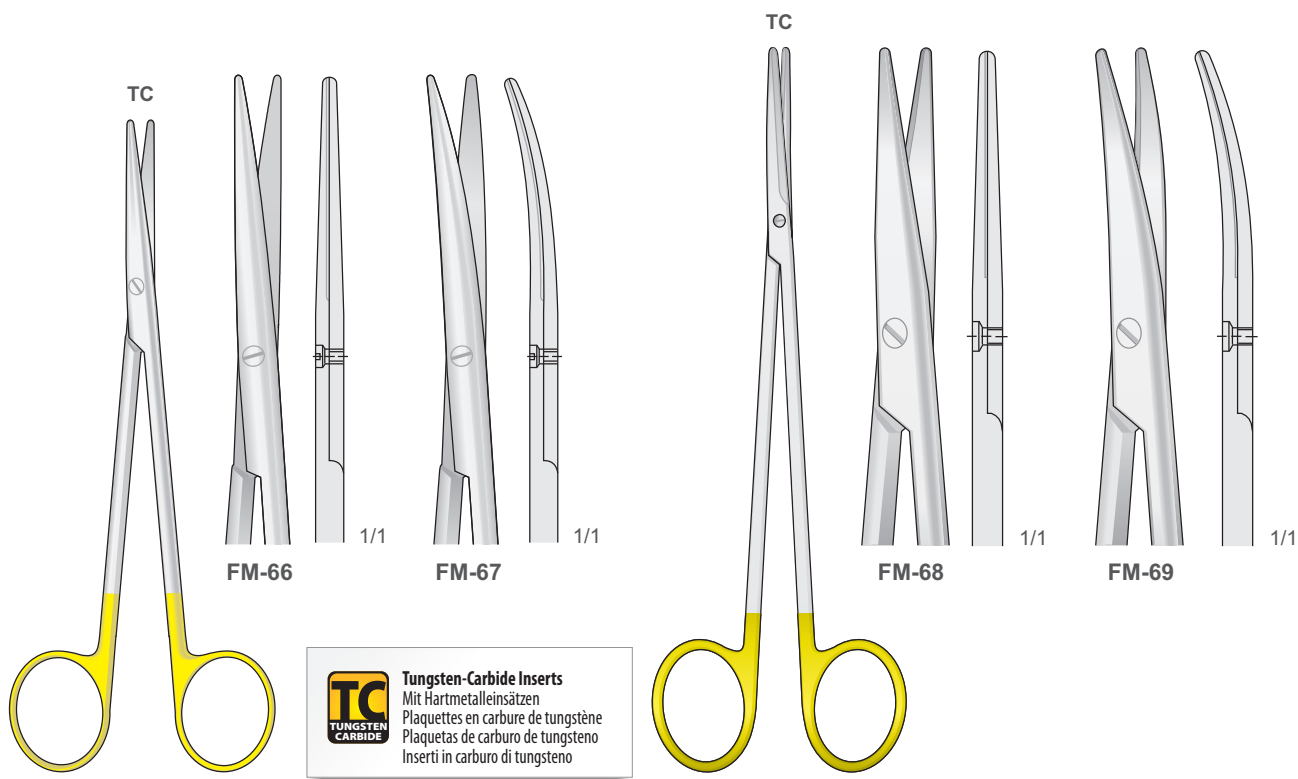

METZENBAUM
FM-66/FM-67
145 mm

METZENBAUM
FM-68/FM-69
185 mm

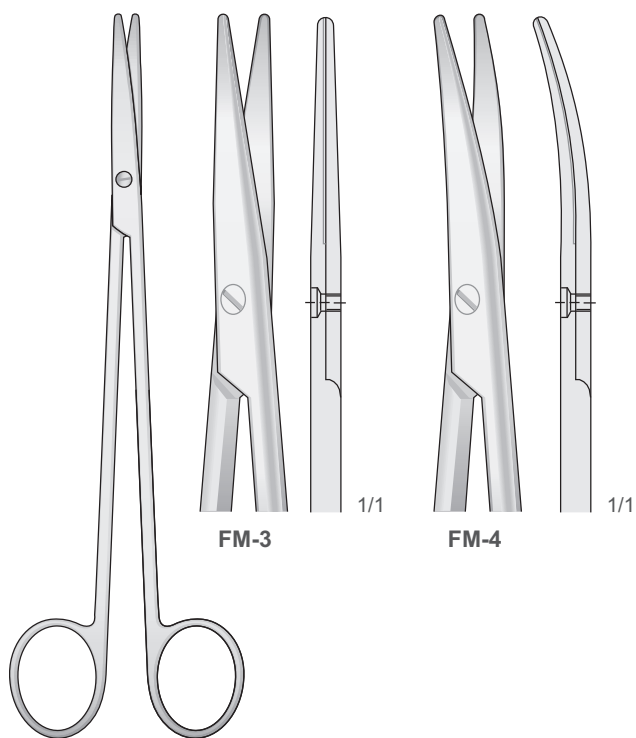

METZENBAUM
FM-3/FM-4
185 mm

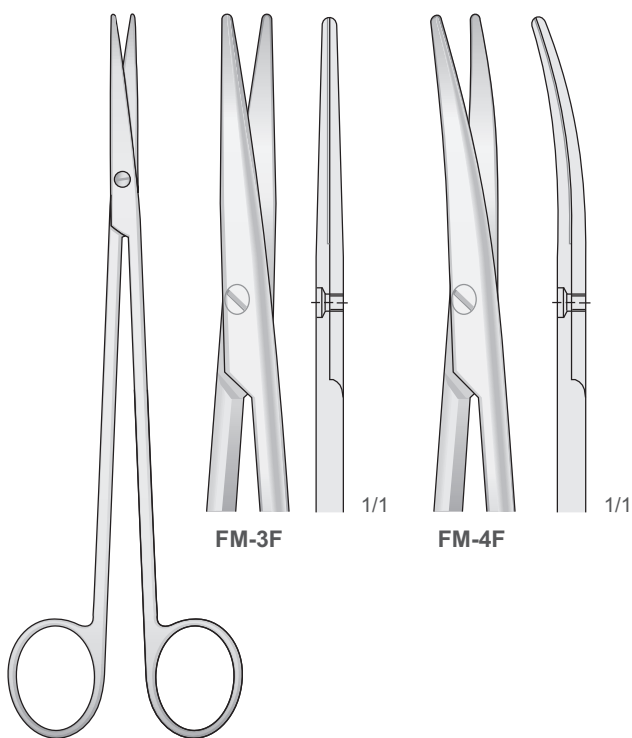

METZENBAUM-FINO
FM-3F/FM-4F
185 mm

Scissors

Scheren
Forbici
Tijeras
Ciseaux

Scissors

Scheren
Forbici
Tijeras
Ciseaux

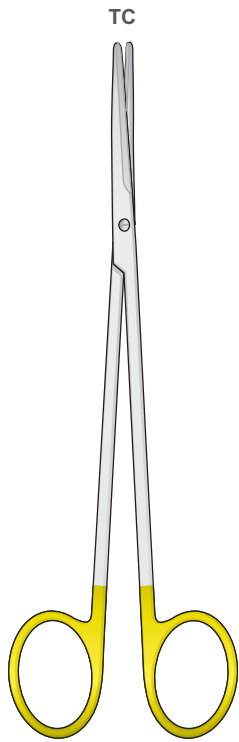

METZENBAUM-FINO
FM-201/FM-204

TC

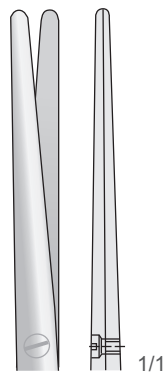

FM-201
140 mm

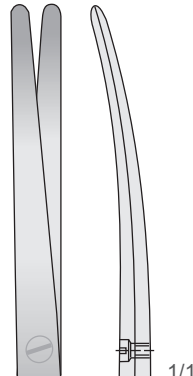

FM-202
140 mm

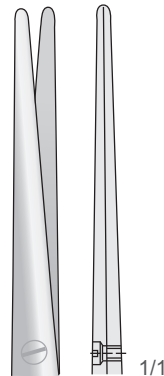

FM-203
180 mm

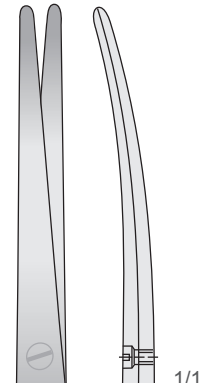

FM-204
180 mm



Tungsten-Carbide Inserts
Mit Hartmetalleinsätzen
Plaquettes en carbure de tungstène
Plaquetas de carburo de tungsteno
Inserti in carburo di tungsteno

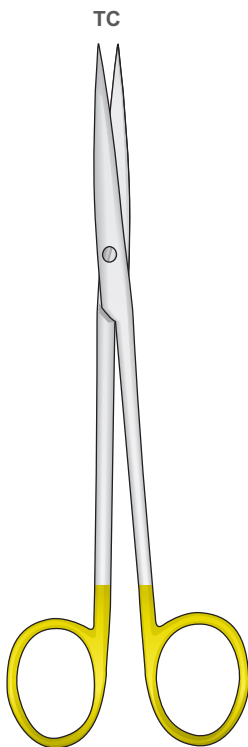

METZENBAUM-FINO
FM-96/FM-99

TC

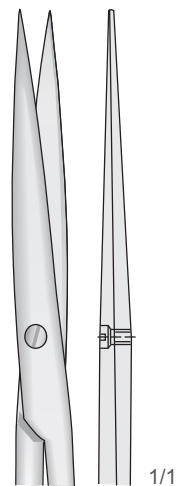

FM-96
140 mm

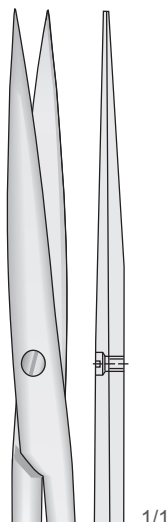

FM-97
180 mm

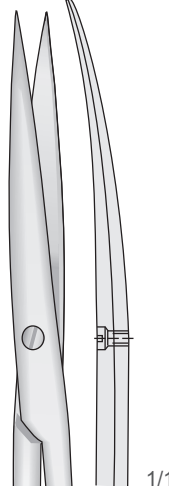

FM-98
140 mm

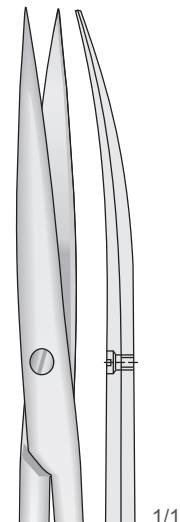

FM-99
180 mm

Scissors

Scheren
Forbici
Tijeras
Ciseaux

Scheren
Scissors
Forbici
Tijeras
Ciseaux

TC
TUNGSTEN
CARBIDE

Tungsten-Carbide Inserts
Mit Hartmetalleinsätzen
Plaquettes en carbure de tungstène
Plaquetas de carburo de tungsteno
Inserti in carburo di tungsteno

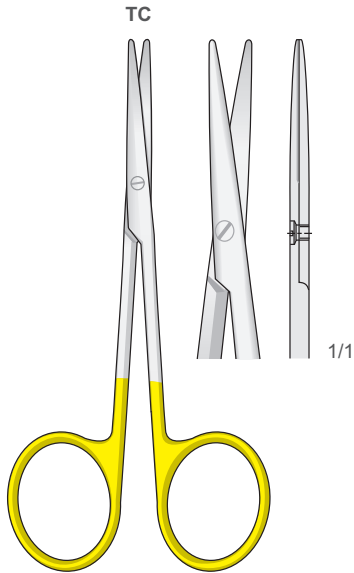

BABY-METZENBAUM
FM-118
115 mm

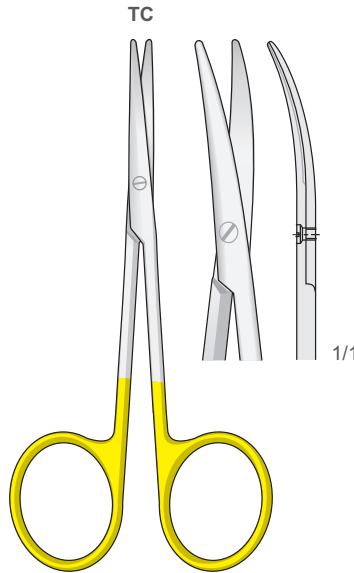

BABY-METZENBAUM
FM-119
115 mm

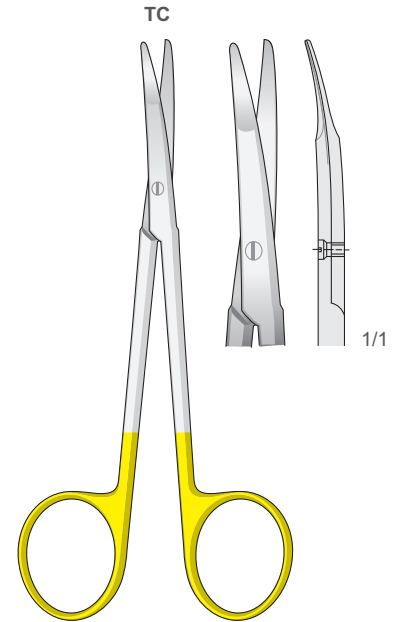

KILNER
FM-350
125 mm

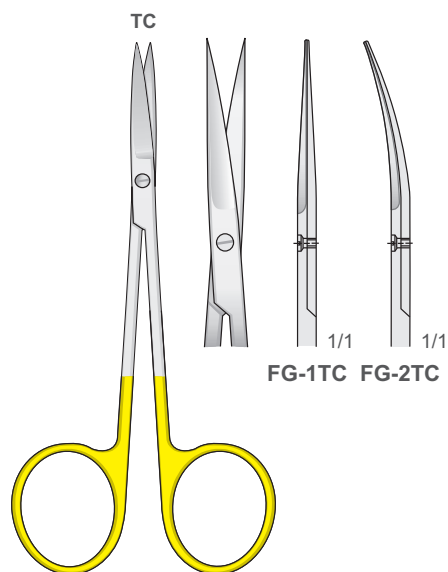

IRIS
FG-1TC/FG-2TC
115 mm

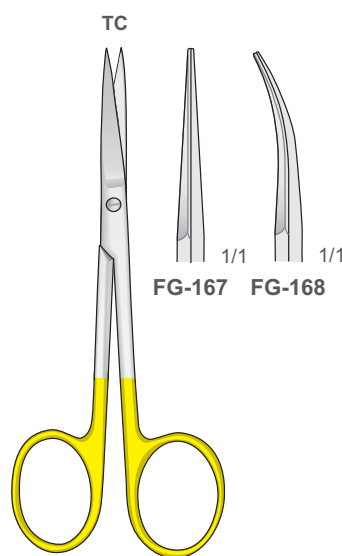

FG-167/FG-168
110 mm

Gebogen - Curved
Curva - Curvas
Courbes

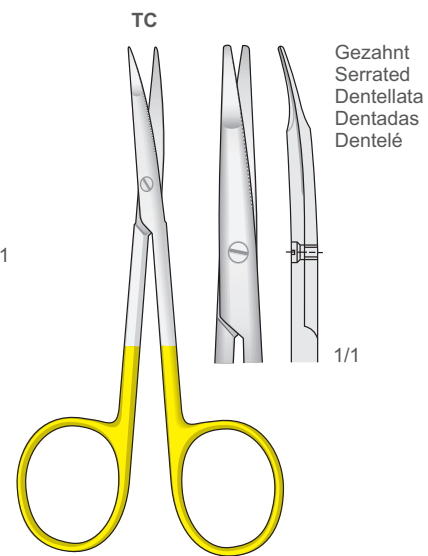

GREENBERG-PAR
FM-317
115 mm

Gezahnt
Serrated
Dentellata
Dentadas
Dentelé

Scissors

Scheren
Forbici
Tijeras
Ciseaux

Scissors

Scheren
Forbici
Tijeras
Ciseaux

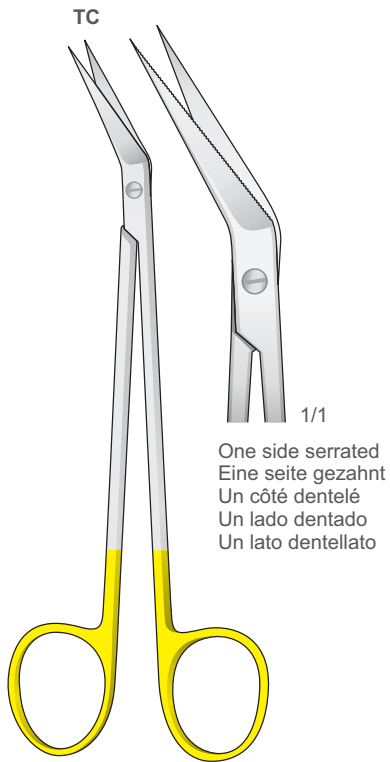

LK-10
160 mm

One side serrated
Eine seite gezahnt
Un côté dentelé
Un lado dentado
Un lato dentellato

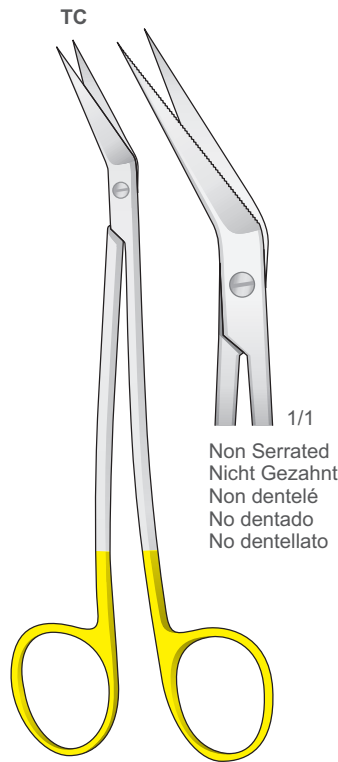

LK-12
160 mm

Non Serrated
Nicht Gezahnt
Non dentelé
No dentado
No dentellato



Tungsten-Carbide Inserts
Mit Hartmetalleinsätzen
Plaquettes en carbure de tungstène
Plaquetas de carburo de tungsteno
Inserti in carburo di tungsteno

Eine Schneide gezahnt S-förmig gebogen
One toothed cutting edge S-shaped
Una lama dentata curva a forma S
Una hoja dentada forma S
Une lame dentelée courbés en S

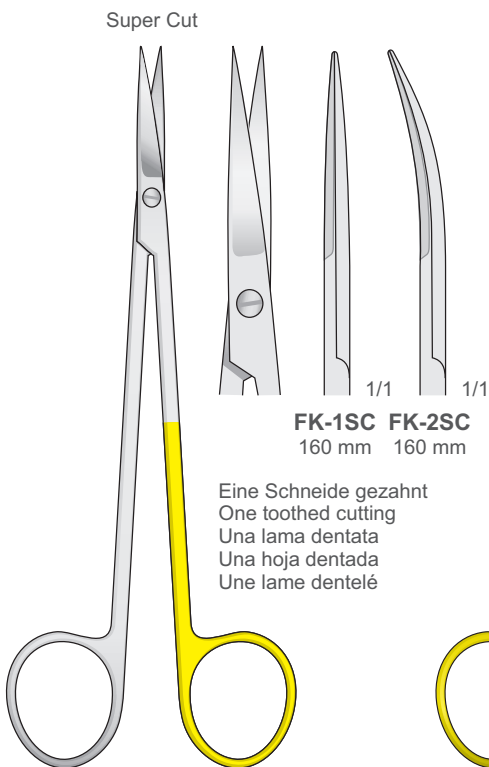

KELLY
FK-1SC/FK-2SC
160 mm

Eine Schneide gezahnt
One toothed cutting
Una lama dentata
Una hoja dentada
Une lame dentelé

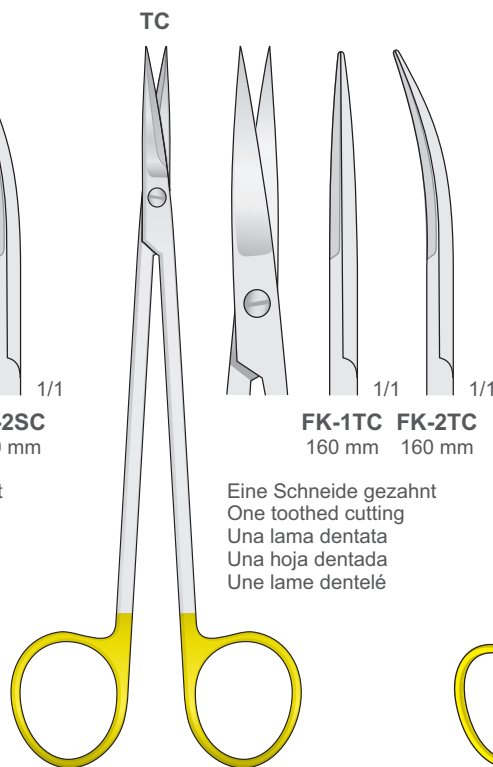

KELLY
FK-1TC/FK-2TC
160 mm

Eine Schneide gezahnt
One toothed cutting
Una lama dentata
Una hoja dentada
Une lame dentelé

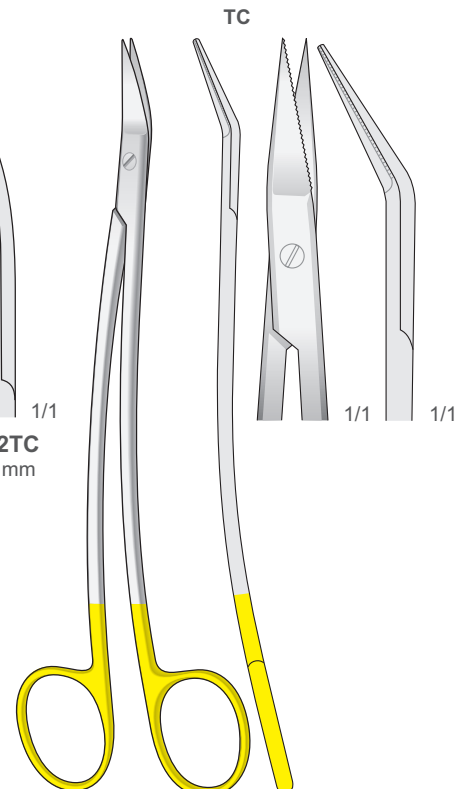

DEAN-TC
175 mm

Scissors

Scheren
Forbici
Tijeras
Ciseaux

Wellenschliff
TC

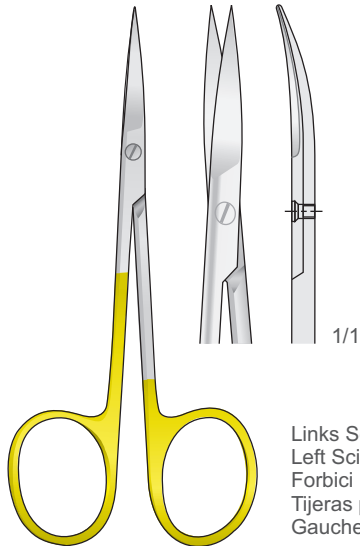

IRIS
FM-100L
110 mm

Links Scheren
Left Scissors
Forbici per mancini
Tijeras para zurdos
Gauche Ciseaux



Wellenschliff
TC

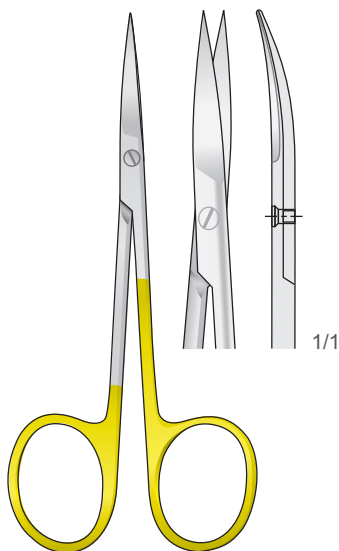

IRIS
FM-100
110 mm

Wellenschliff
TC

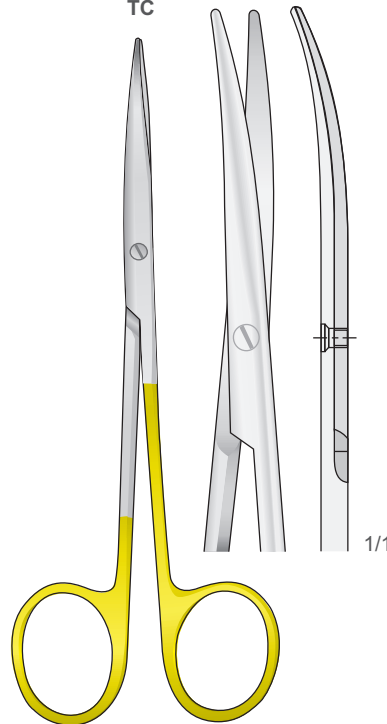

METZENBAUM
FM-102
145 mm

Wellenschliff
TC

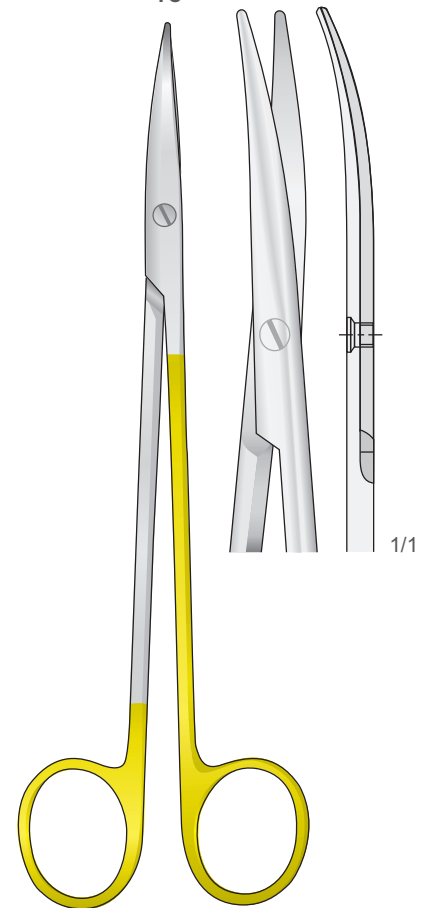

METZENBAUM
FM-104
185 mm

Scissors

Scheren
Forbici
Tijeras
Ciseaux

Scissors

Scheren
Forbici
Tijeras
Ciseaux



Extremely Sharp Razor Edge / Atraumatic
Extrem Scharfe Spitzer Beck / Atraumatische
Tranchant extrêmement aiguïssée / Atraumatique
Borde extremadamente afilado / Atraumática
Taglio estremamente affilato / Atraumatica

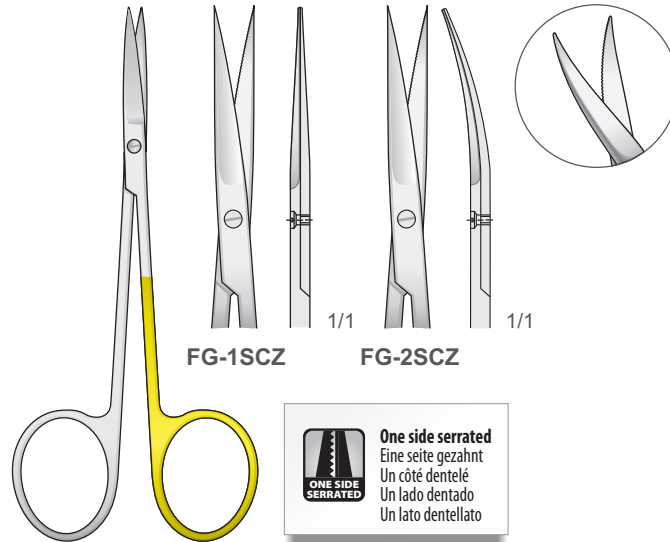

FG-1SCZ/FG-2SCZ
110 mm

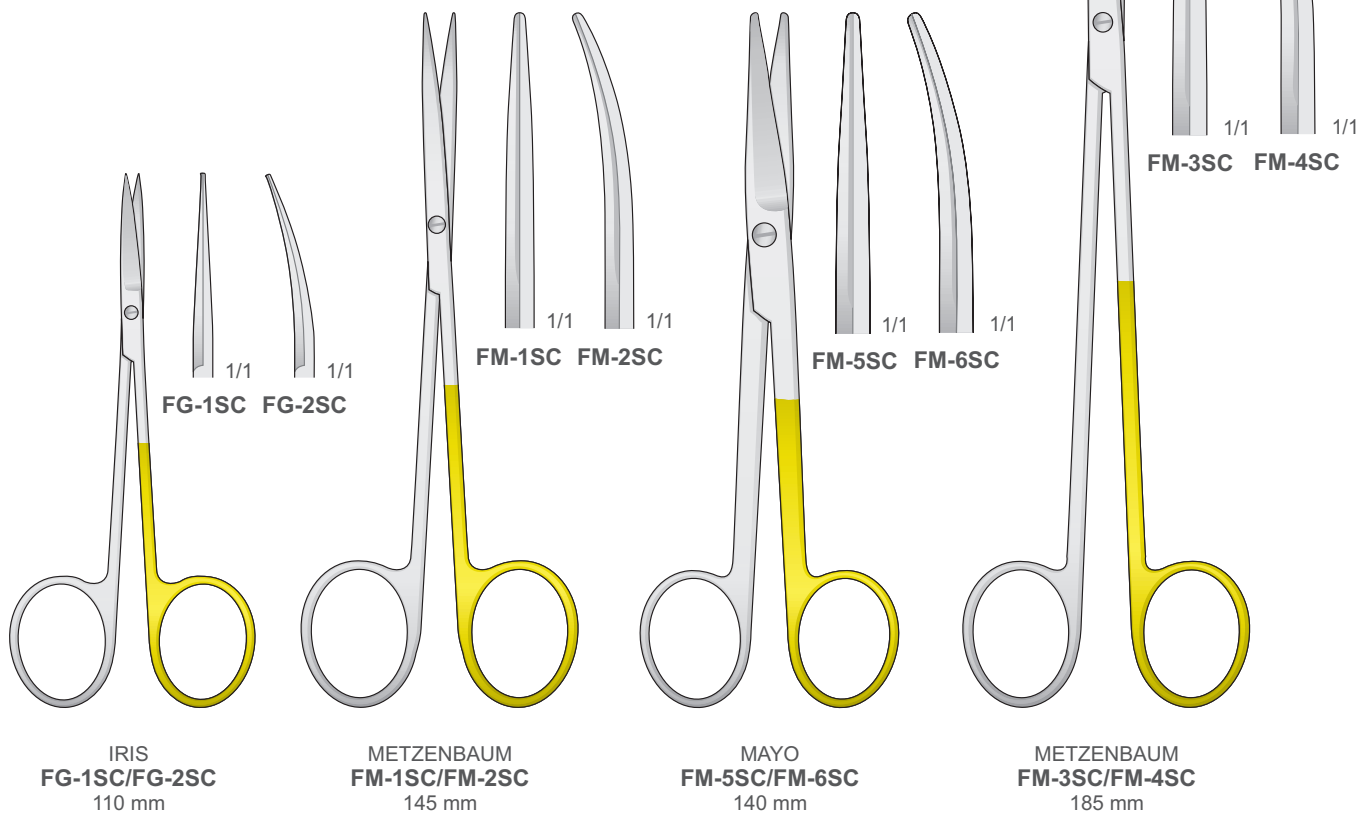

IRIS
FG-1SC/FG-2SC
110 mm

METZENBAUM
FM-1SC/FM-2SC
145 mm

MAYO
FM-5SC/FM-6SC
140 mm

METZENBAUM
FM-3SC/FM-4SC
185 mm

Scissors

Scheren
Forbici
Tijeras
Ciseaux

SUPER CUT



Super Cut Scissors have specially designed cutting edges.
One regular edge and **one sharp-knife edge.**



Extremely Sharp Razor Edge / Atraumatic
Extrem Scharfe Spitzer Beck / Atraumatische
Tranchant extrêmement aiguisée / Atraumatique
Borde extremadamente afilado / Atraumática
Taglio estremamente affilato / Atraumatica



One side serrated
Eine seite gezahnt
Un côté dentelé
Un lado dentado
Un lato dentellato

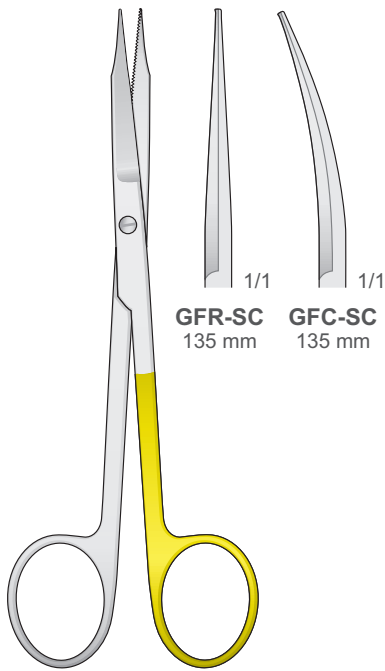

**GOLDMAN-FOX
GFR-SC/GFC-SC**
135 mm

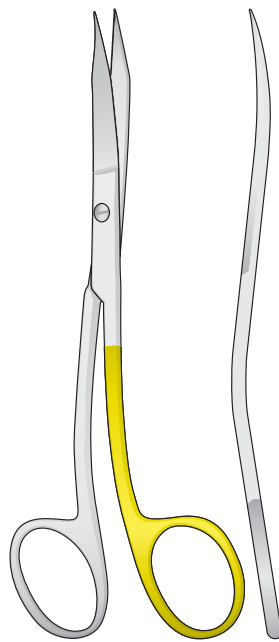

**GOLDMAN-FOX S FORM
GFS-SC**
130 mm

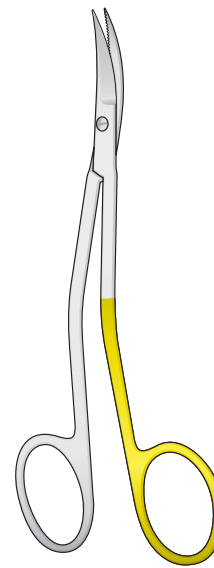

**LA GRANGE
LG-1SC/LG-2SC**
115 mm

Spitz
Sharp
Acute
Agudas
Pointu

Stumpf
Blunt
Smusse
Romas
Mousse

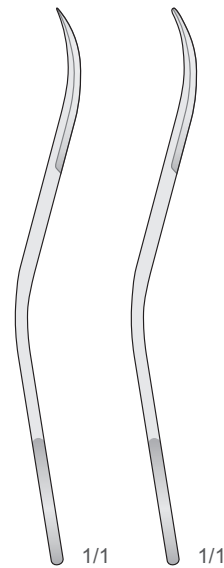

**LA GRANGE
LA GRANGE
LG-1SC LG-2SC**

Scissors

Scheren
Forbici
Tijeras
Ciseaux

Scissors

Scheren
Forbici
Tijeras
Ciseaux

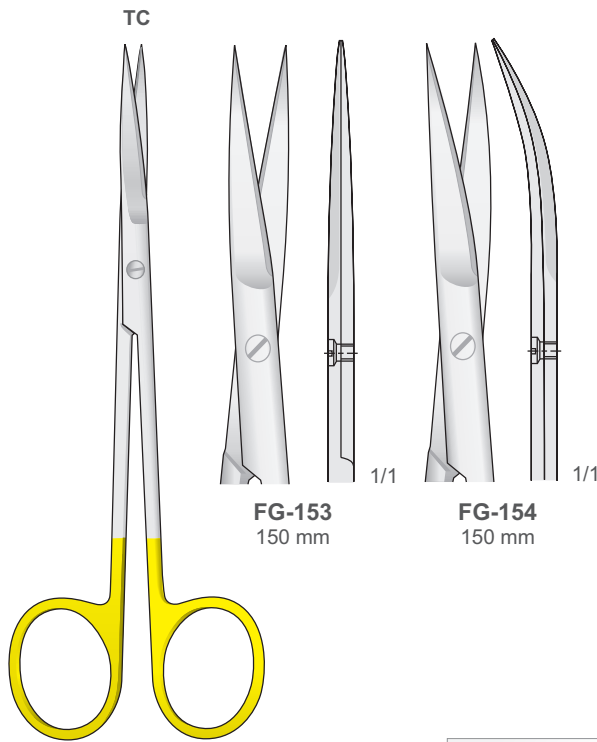

JOSEPH
FG-153/FG-154
150 mm

TC
TUNGSTEN
CARBIDE

Tungsten-Carbide Inserts
Mit Hartmetalleinsätzen
Plaquettes en carbure de tungstène
Plaquetas de carburo de tungsteno
Inserti in carburo di tungsteno

**ONE SIDE
SERRATED**

One side serrated
Eine seite gezahnt
Un côté dentelé
Un lado dentado
Un lato dentellato

**ONE SIDE
SERRATED**

One side serrated
Eine seite gezahnt
Un côté dentelé
Un lado dentado
Un lato dentellato

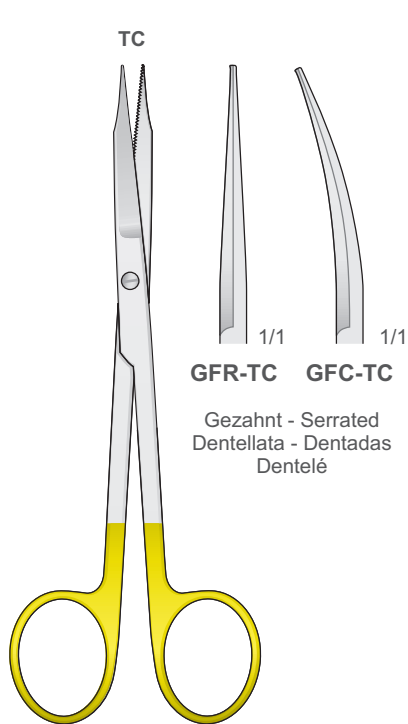

GOLDMAN-FOX
GFC-TC/GFR-TC
135 mm

GFR-TC GFC-TC
Gezahnt - Serrated
Dentellata - Dentadas
Dentelé

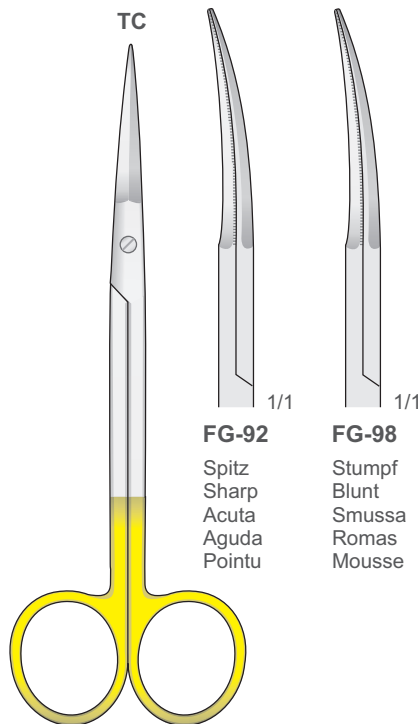

PECK-JOSEPH
FG-92/FG-98
140 mm

FG-92 FG-98
Spitz
Sharp
Acuta
Aguda
Pointu
Stumpf
Blunt
Smussa
Romass
Mousse

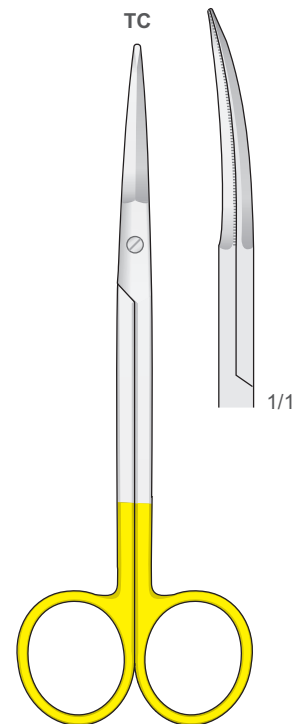

GREGORY
FM-339
140 mm

Scissors

Scheren
Forbici
Tijeras
Ciseaux

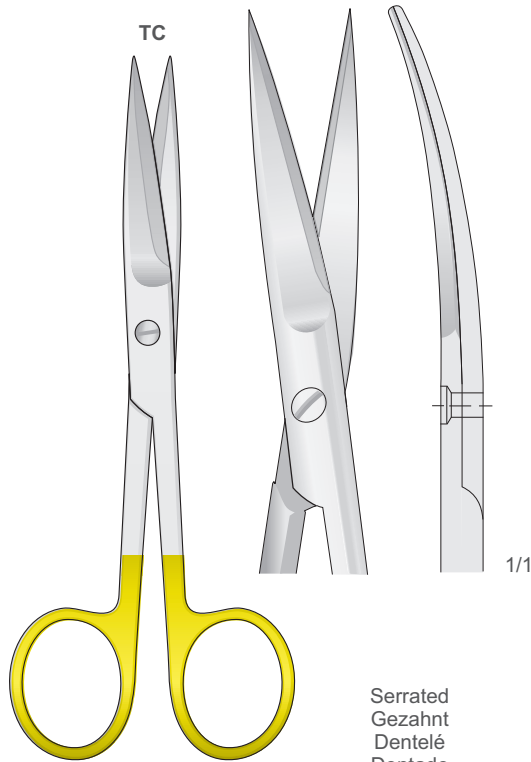

FM-146
145 mm

TC
TUNGSTEN
CARBIDE

Tungsten-Carbide Inserts
Mit Hartmetalleinsätzen
Plaquettes en carbure de tungstène
Plaquetas de carburo de tungsteno
Inserti in carburo di tungsteno

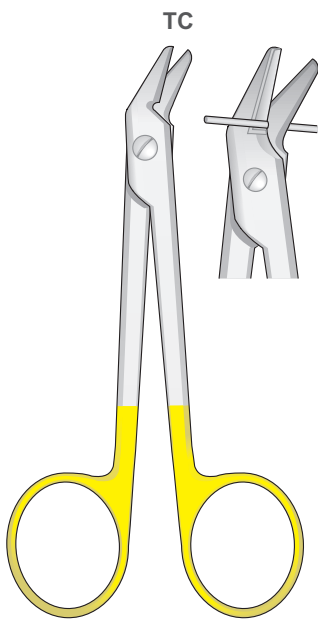

DP-120
120 mm

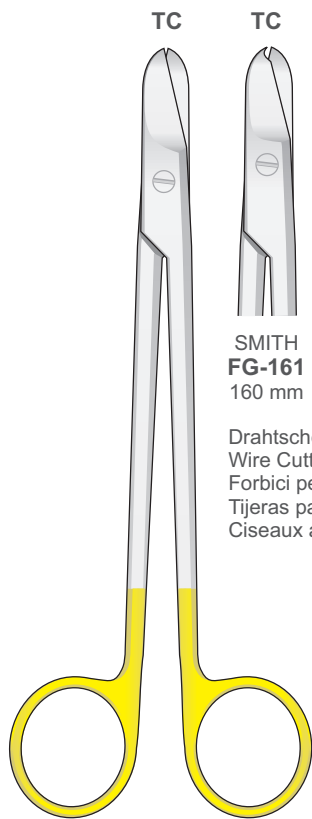

**SMITH
FG-160**
160 mm

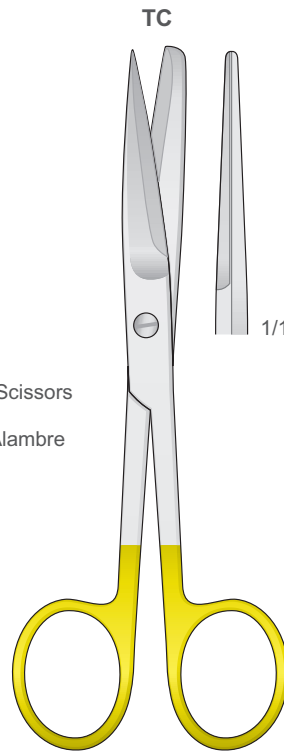

FM-51
145 mm

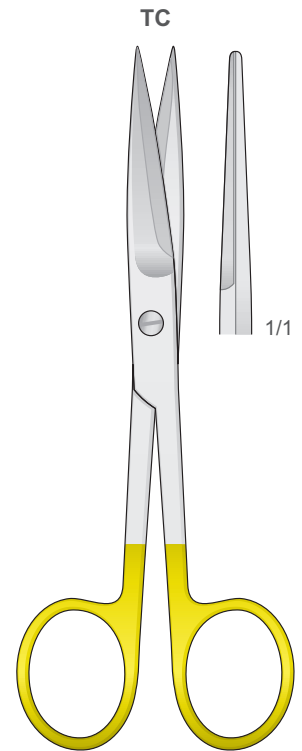

FM-59
145 mm

Ligature Scissors

Ligatur Scheren
Forbici per legature
Tijeras para ligaduras
Ciseaux à ligatures

Scissors

Scheren
Forbici
Tijeras
Ciseaux

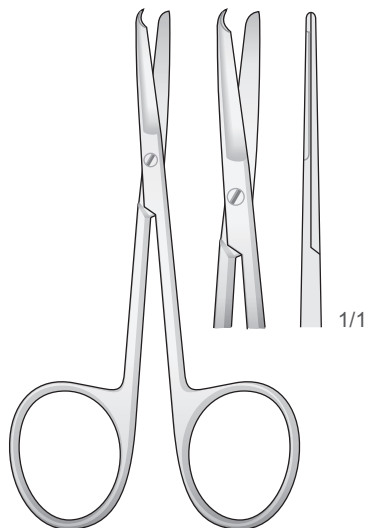

SPENCER
SC-9
90 mm

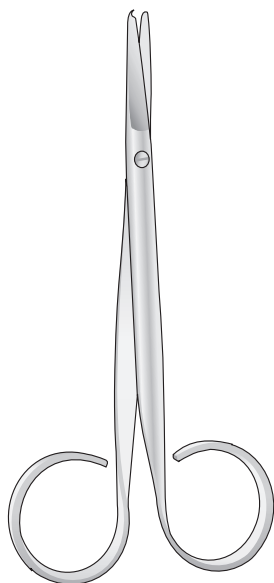

SPENCER
SC-1
110 mm

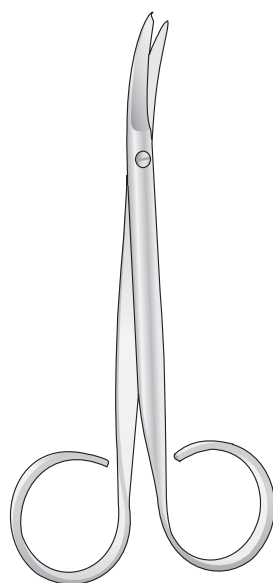

SPENCER
SC-5
110 mm

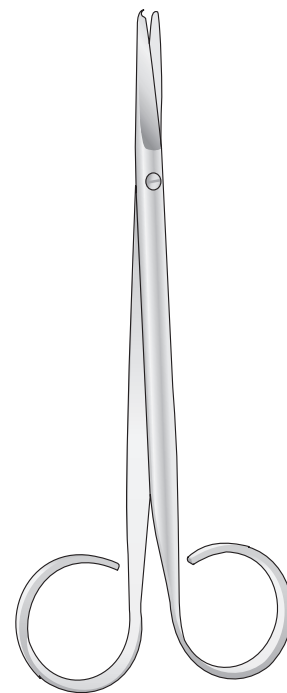

SPENCER
SC-2
145 mm

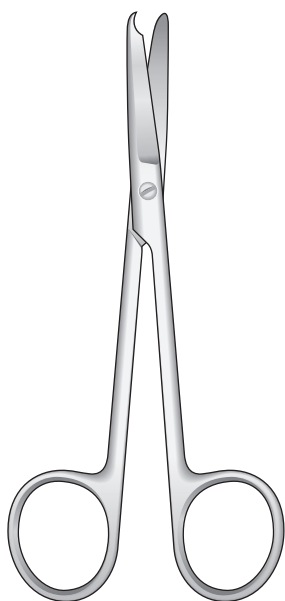

SPENCER
SC-14
120 mm

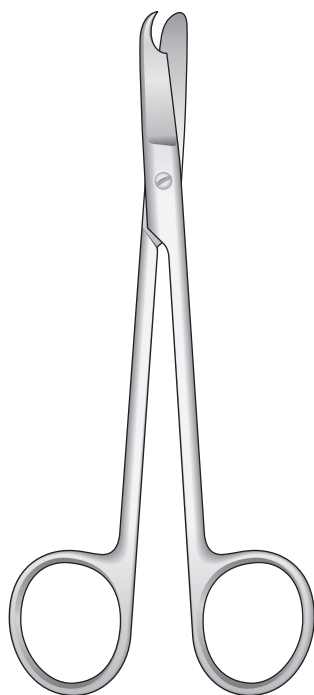

LITTAUER
SC-15
140 mm

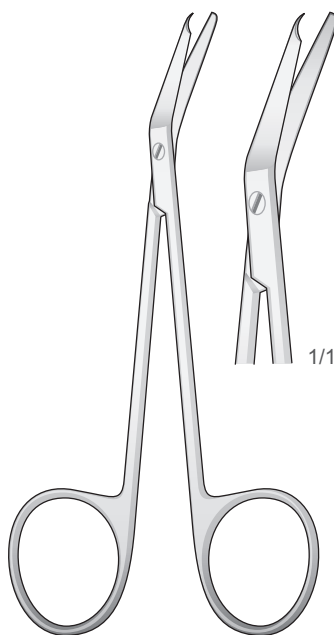

SPENCER
SC-13
130 mm

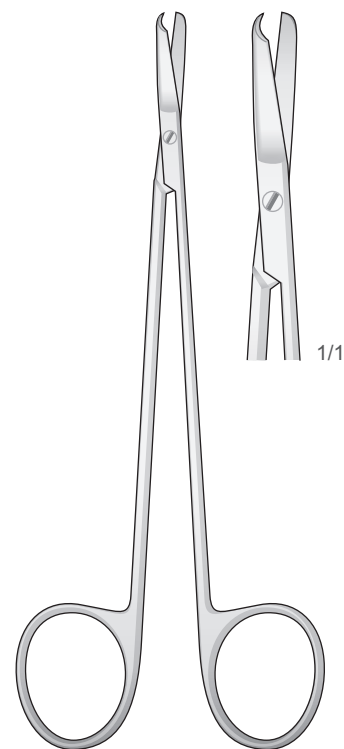

KELLY
SC-16
150 mm

Wire and plate cutting scissors

Draht und blechscheren
 Forbici per fili metallici
 Tijeras para cortar alambre
 Ciseaux coupe-fils métalliques

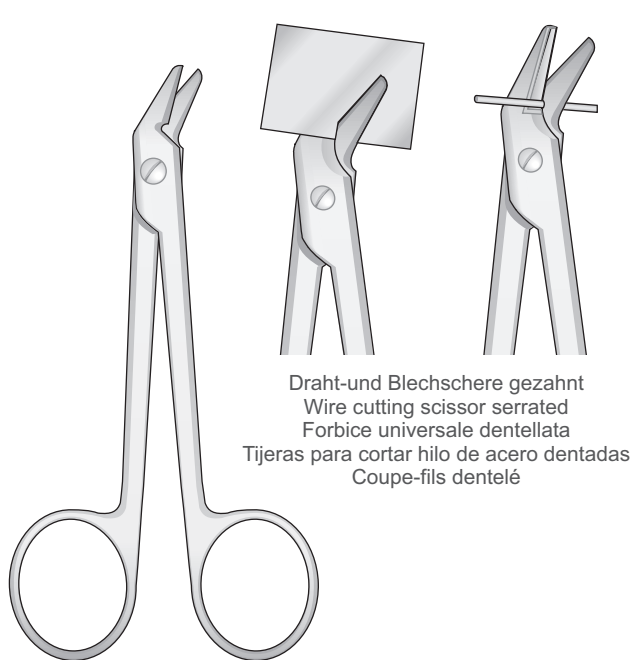

Draht- und Blechschere gezahnt
 Wire cutting scissor serrated
 Forbice universale dentellata
 Tijeras para cortar hilo de acero dentadas
 Coupe-fils dentelé

DP-90
 120 mm

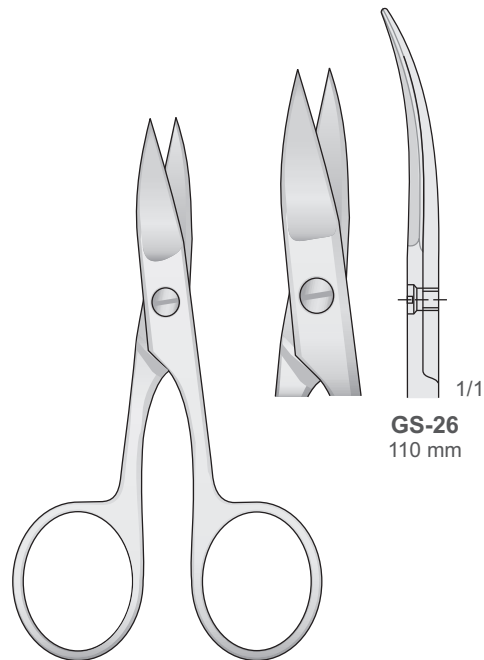

GS-26
 110 mm

GS-26
 110 mm

Spitz
 Sharp
 Acute
 Agudas
 Pointu



BEEBE
DP-91/DP-101
 110 mm

Stumpf
 Blunt
 Smusse
 Romas
 Mousse

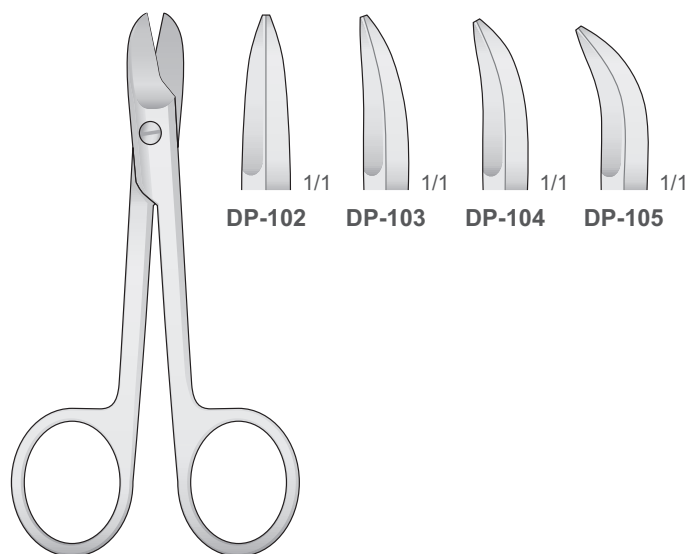

BEEBE
DP-102/DP-105
 110 mm