

**PERIODONTICS  
ENDODONTICS  
RESTORATION**

## Explorers - Sickle Probes

Zahnsonden  
Esploratori - Sonde falce  
Sondas exploradoras  
Sondes exploratrices

## Periodontics / Endodontics / Restoration

Parodontologie / Endodontie / Restauration  
Parodontie / Endodontie / Restauration  
Parodontologia / Endodonzia / Restauro  
Parodontologiya / Endodontiya / Restavratsiya

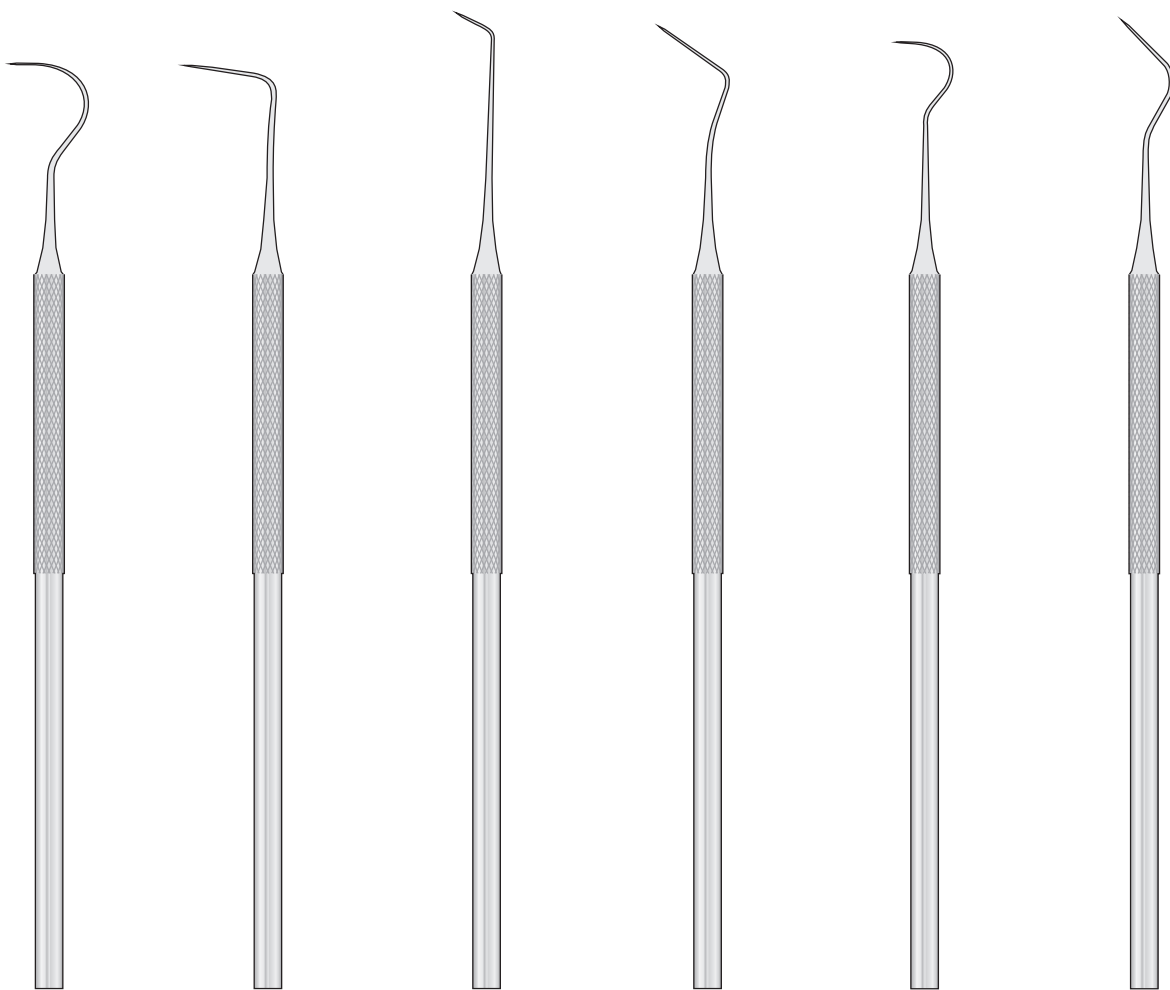

**SO-1**  
Fig. 23

**SO-2**  
Fig. 11

**SO-3**  
Fig. 6

**SO-4**  
Fig. 9

**SO-5**  
Fig. 2

**SO-6**  
Fig. 10

## Explorers - Sickle Probes

Zahnsonden  
Esploratori - Sonde falce  
Sondas exploradoras  
Sondes exploratrices

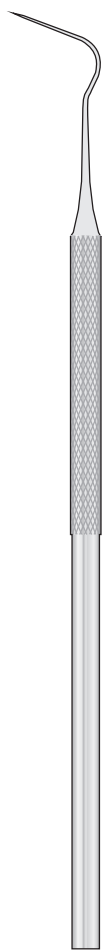

**SO-7**  
Fig. 12

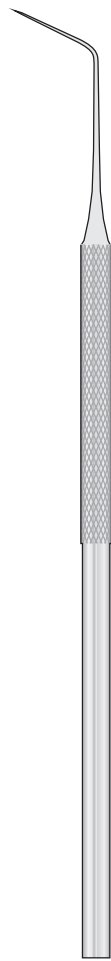

**SO-8**  
Fig. 6A



**SO-9**  
Fig. 8A

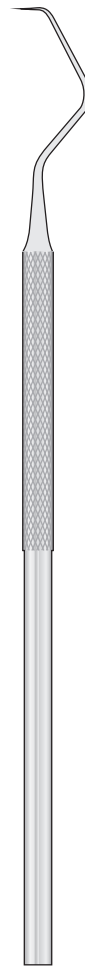

**SO-10**  
Fig. 17A



**SO-11**  
Fig. 3A

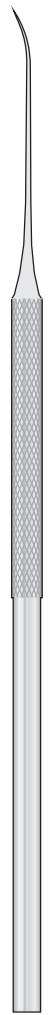

**SO-12**  
Fig. 3

## Periodontal Probes

Parodontometer  
Sonde parodontali  
Sondas parodontales  
Sondes parodontales

## Periodontics / Endodontics / Restoration

Parodontologie / Endodontie / Restauration  
Parodontie / Endodontie / Restauration  
Parodontologia / Endodonzia / Restauo  
Parodontologiya / Endodontiya / Restavratsiya

**Do not use Ultrasonic Cleaning**  
Verwenden Sie keine Ultraschall-Reinigung  
Ne pas utiliser nettoyage à ultrasons  
No usar limpieza ultrasónica  
Non usare lavatrici ad ultrasuoni



**Do not use metal brushes**  
Keine Drahtbürste verwenden  
Ne pas utiliser de brosses métalliques  
No utilizar cepillos metálicos  
Non utilizzare spazzole metalliche

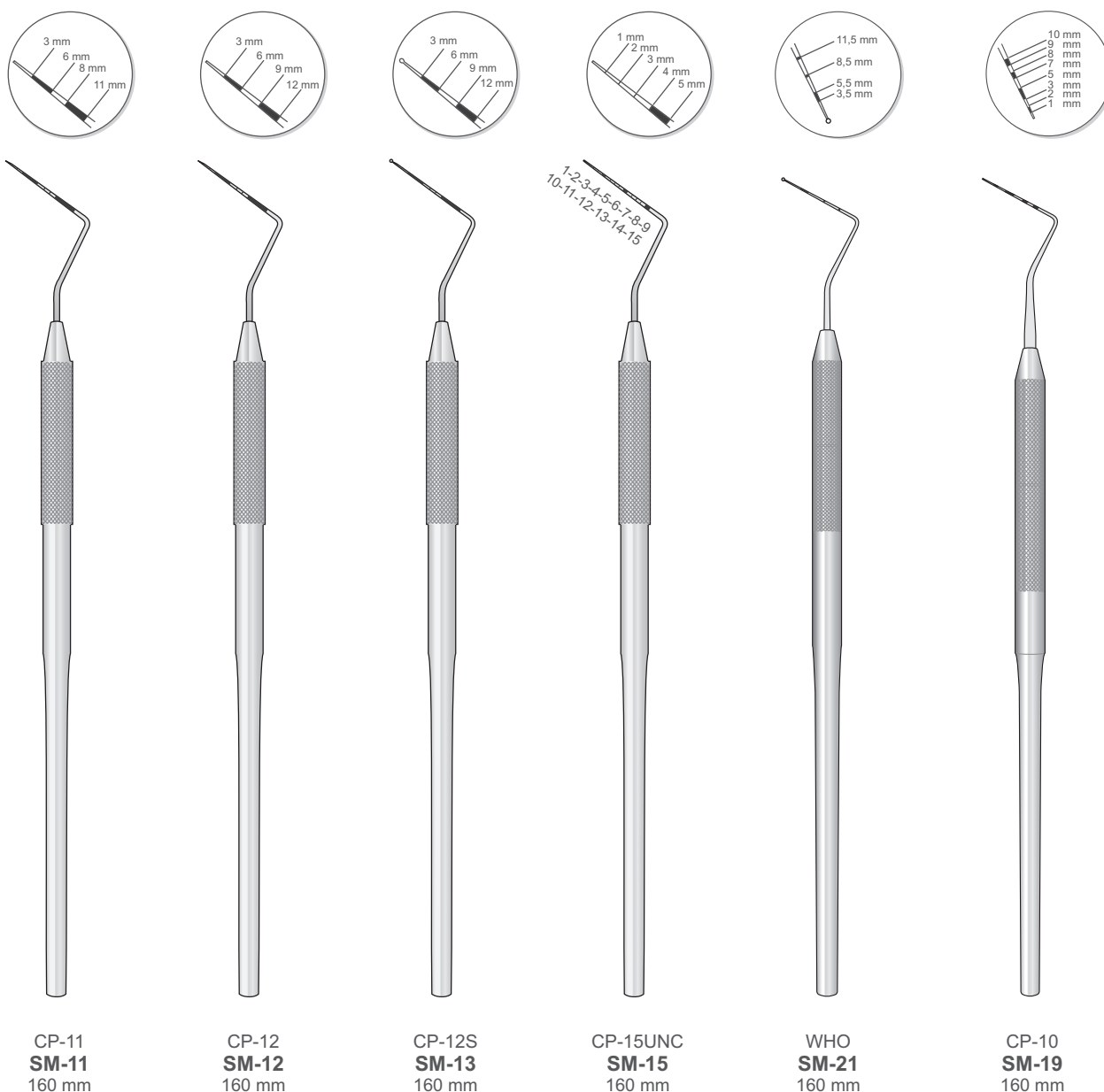

**Periodontal Probes**

Parodontometer  
 Sonde parodontali  
 Sondas parodontales  
 Sondes parodontales

Double-ended Explorer  
 Doppelendiger Zahnsonden  
 Sonde exploratrice double  
 Sonda exploradora doble  
 Sonda falce doppia



11/12 ODU  
**SO-20**  
 165 mm

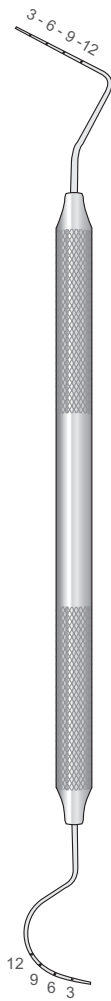

CATTONI  
 UT3/4  
**SM-20**  
 165 mm

3 - 6 - 9 - 12

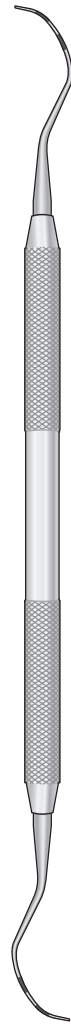

12 - 9 - 6 - 3  
 NABERS  
 2QN  
**SM-22**  
 175 mm

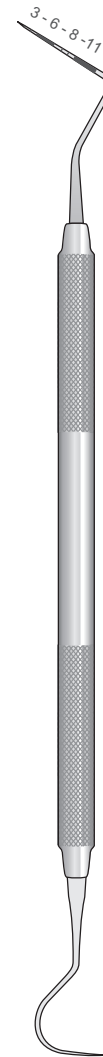
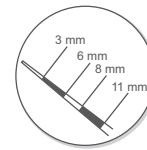

3 - 6 - 8 - 11  
 WILLIAMS  
 23 CP-11  
**EX-11**  
 165 mm

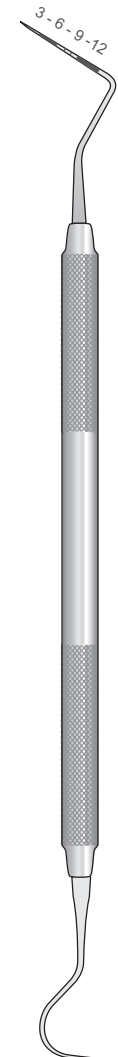

3 - 6 - 9 - 12  
 WILLIAMS  
 23 CP-12  
**EX-12**  
 165 mm

## Periodontal Probes

Parodontometer  
Sonde parodontali  
Sondas parodontales  
Sondes parodontales

## Periodontics / Endodontics / Restoration

Parodontologie / Endodontie / Restauration  
Parodontie / Endodontie / Restauration  
Parodontologia / Endodonzia / Restauro  
Parodontologiya / Endodontiya / Restavratsiya

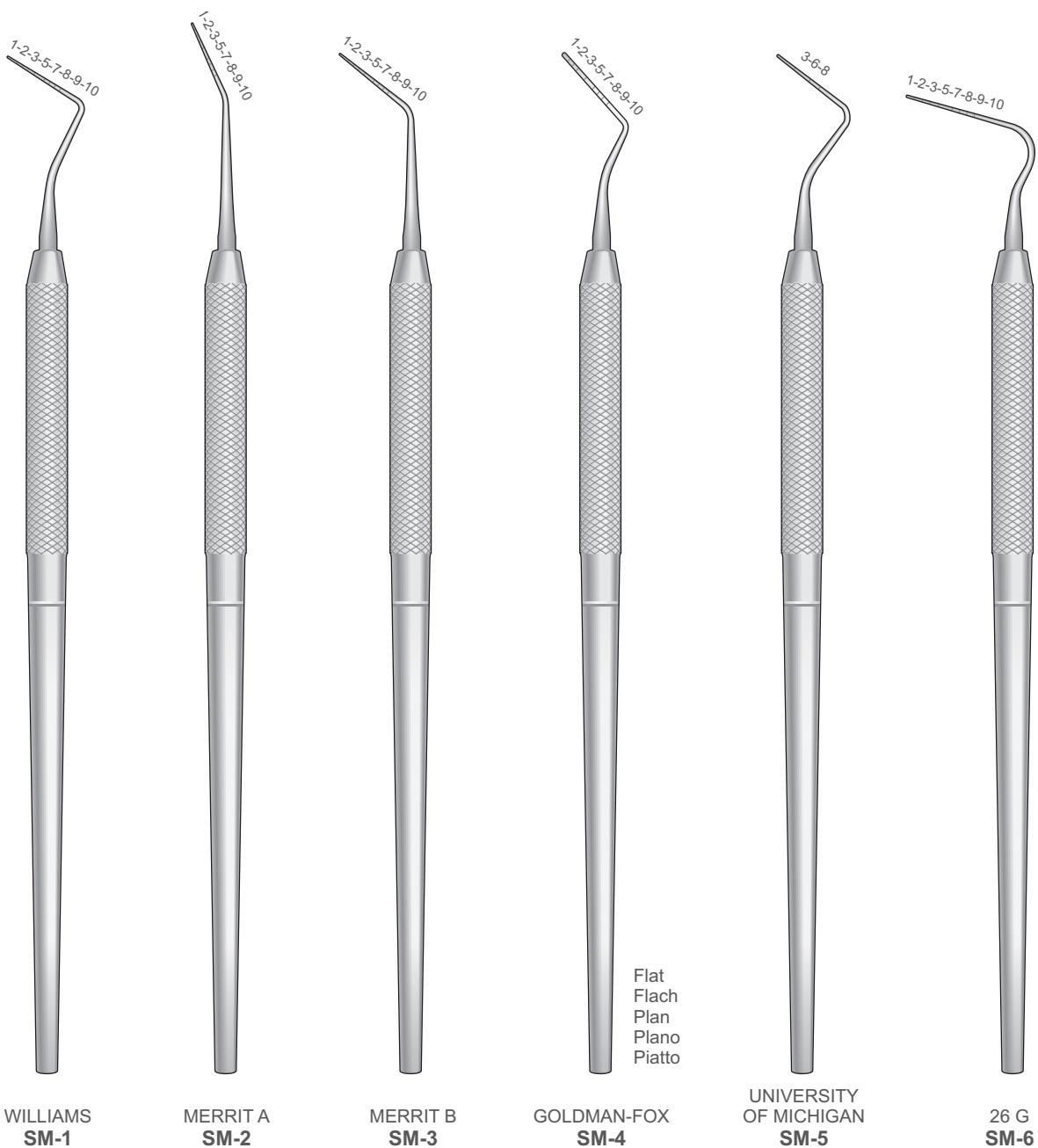

## Endodontic Instruments

Instrumente für Endodontie

Strumenti per Endodonzia

Instrumentos para Endodoncia

Instrumentos pour Endodontie

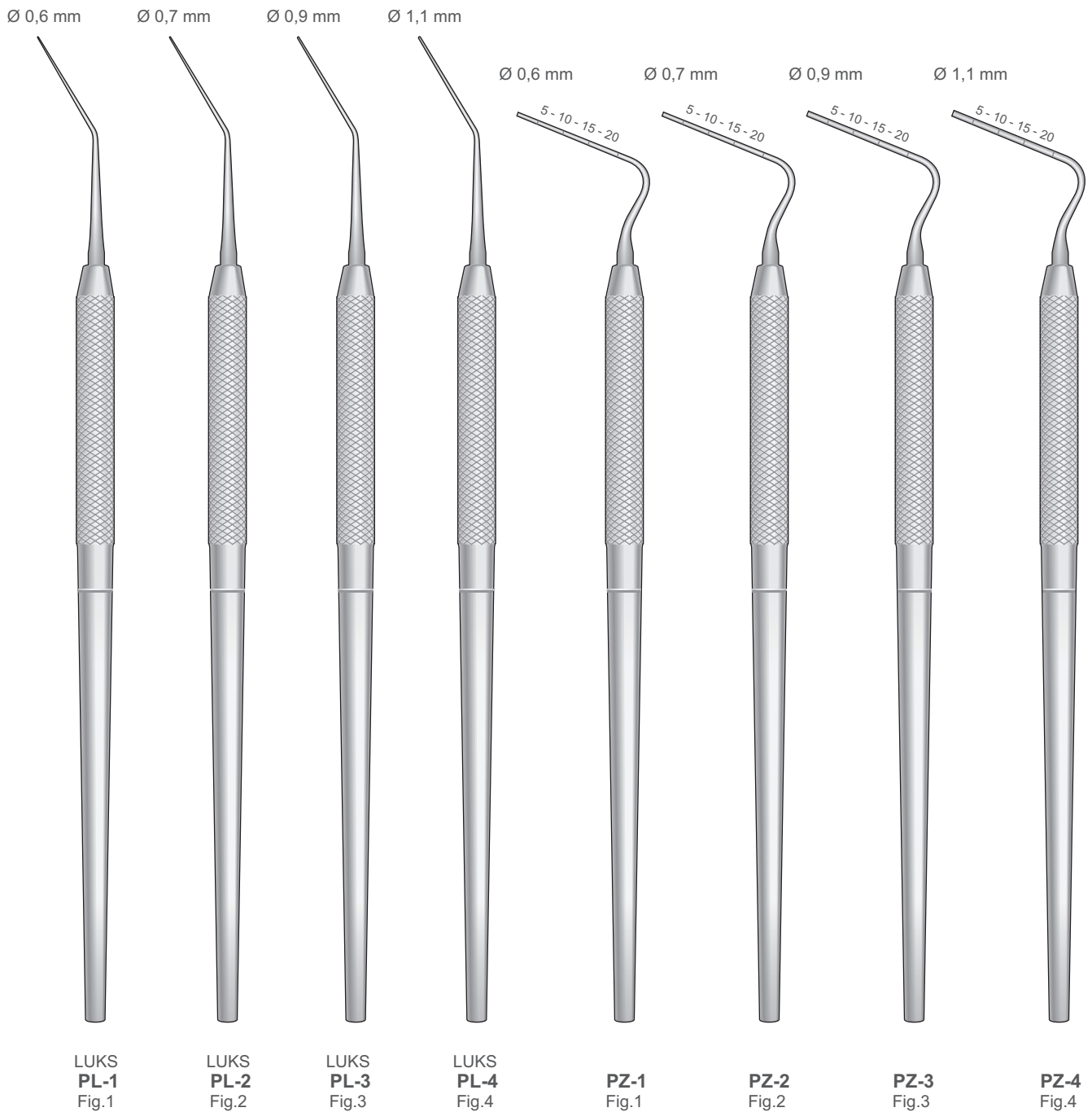

## Endodontic Instruments

Instrumente für Endodontie  
Strumenti per Endonzia  
Instrumentos para Endoncia  
Instruments pour Endodontie

## Periodontics / Endodontics / Restoration

Parodontologie / Endodontie / Restauration  
Parodontie / Endodontie / Restauration  
Parodontologia / Endonzia / Restauro  
Parodontologiya / Endodontiya / Restavratsiya

### Spreaders

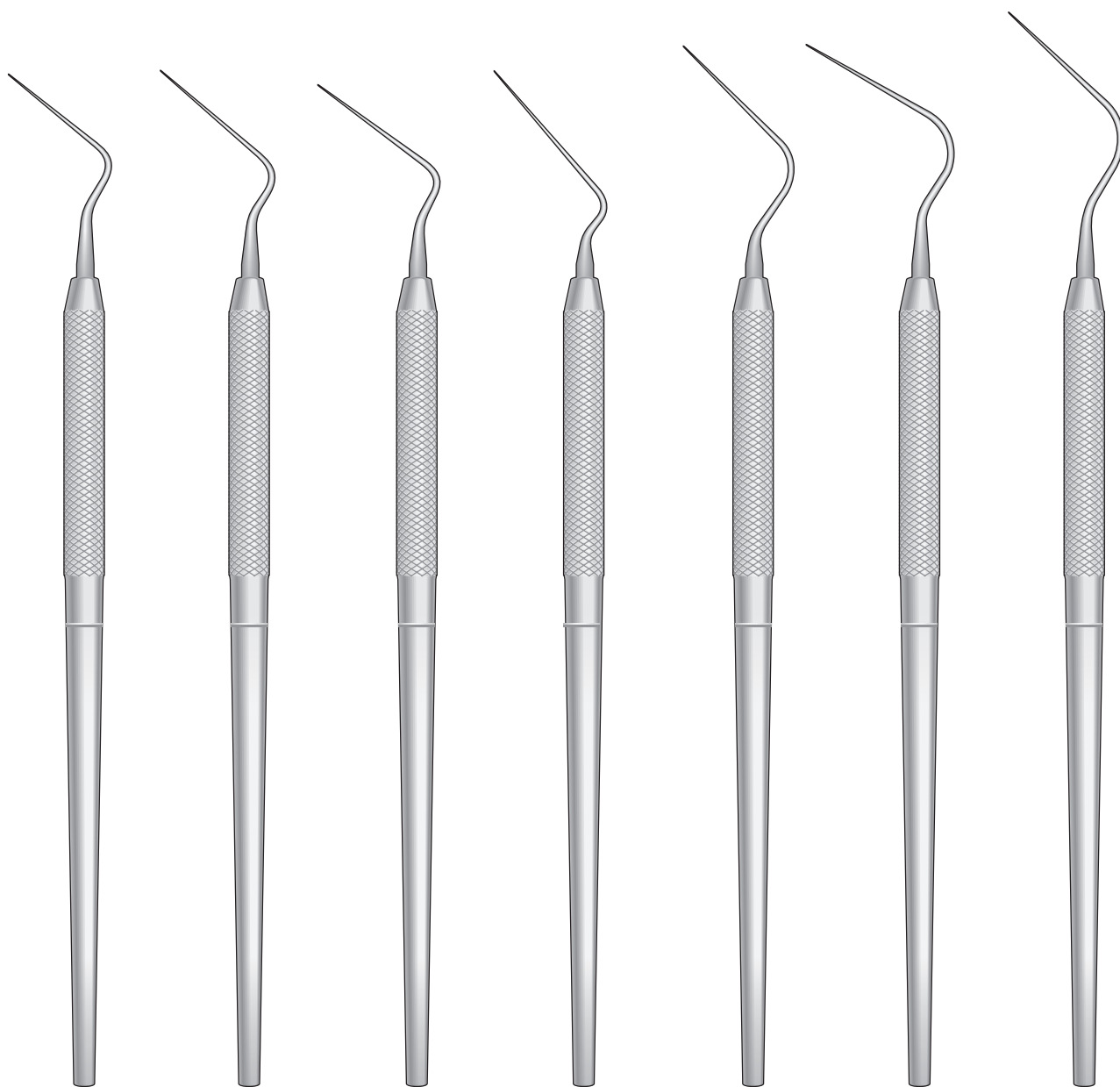

**SP-1**  
Fig.1S

**SP-2**  
Fig.2S

**SP-3**  
Fig.D11

**SP-4**  
Fig.MA57

**SP-5**  
Fig.0

**SP-6**  
Fig.00

**SP-7**  
Fig.3



## Cotton Applicators

Watteträger  
Porta cotone  
Portaalgodón  
Applicateur de coton

Tamponstopfer  
Gauze Packers  
Porta tamponi  
Portatampones  
Porte tampons

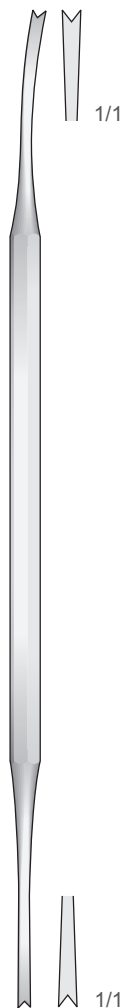

LUNIATSCHEK  
**PF-6**  
170 mm

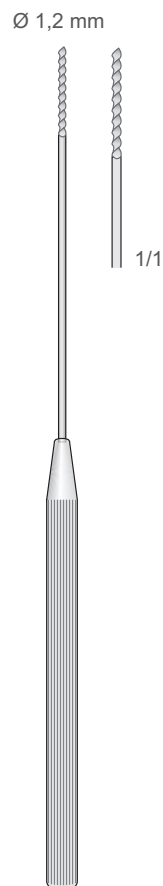

UNIVERSAL  
**PF-40**  
140 mm

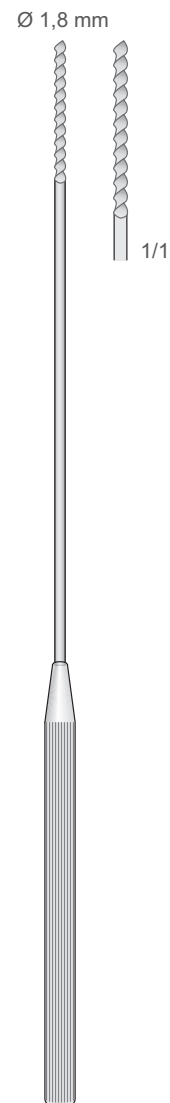

UNIVERSAL  
**PF-41**  
180 mm

## Mirrors and handles

Mundspiegel und Griffe  
Specchietti e manici  
Espejos y mangos  
Miroirs et manches

## Periodontics / Endodontics / Restoration

Parodontologie / Endodontie / Restauration  
Parodontie / Endodontie / Restauration  
Parodontologia / Endodonzia / Restauro  
Parodontologiya / Endodontiya / Restavratsiya

### DOUBLE SIDED FRONT SURFACE RHODIUM MIRROR

Stainless steel - Rhodium coating

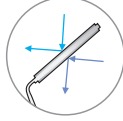

Reflecting surface is on **FRONT** of the glass.  
Clear image. No distortion. No double/ghost image.  
**Rhodium** coating for scratch resistance.  
Enhanced indirect vision & illumination of dark areas.  
Ergonomic & stream-lined design for less bulk.  
+Visibility in any position: **2 opposite reflective faces**  
(no need to turn the mirror to change from right to left).  
Smoothly finished & retractor shaft design for patient comfort.

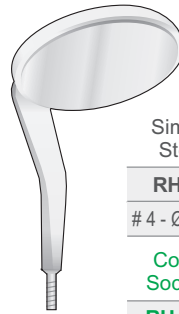

Simple Stem

**RH-14**  
# 4 - Ø 22mm

Cone Socket

**RH-15A**  
# 5 - Ø 24mm

Box of 6

### FRONT SURFACE RHODIUM MIRRORS

Stainless steel - Rhodium coating

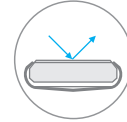

Reflecting surface is on **FRONT** of the glass.  
Clear image. No distortion. No double/ghost image.  
**Rhodium** coating for scratch resistance.  
Enhanced indirect vision & illumination of dark areas.  
Used for retraction of lips, cheeks and tongue.

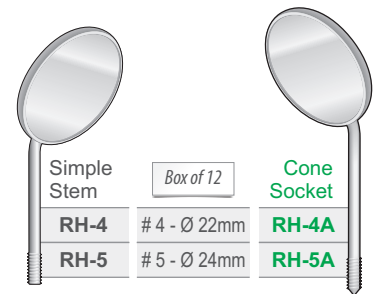

Simple Stem

**RH-4** # 4 - Ø 22mm  
**RH-5** # 5 - Ø 24mm

Box of 12

Cone Socket

**RH-4A**  
**RH-5A**

### PLANE MIRRORS

Stainless steel - Aluminium coating

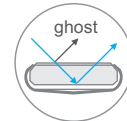

Re ecting surface is on **REAR** of the glass.  
Aluminium coating. Good image quality.  
Flat mirror produce double/ghost image.  
**Low-cost.**



Simple Stem

Box of 12

**P-3** # 3 - Ø 18mm  
**P-4** # 4 - Ø 22mm  
**P-5** # 5 - Ø 24mm

Concave with enlarging effect



Simple Stem

Box of 12

**G-3** # 3 - Ø 18mm  
**G-4** # 4 - Ø 22mm  
**G-5** # 5 - Ø 24mm

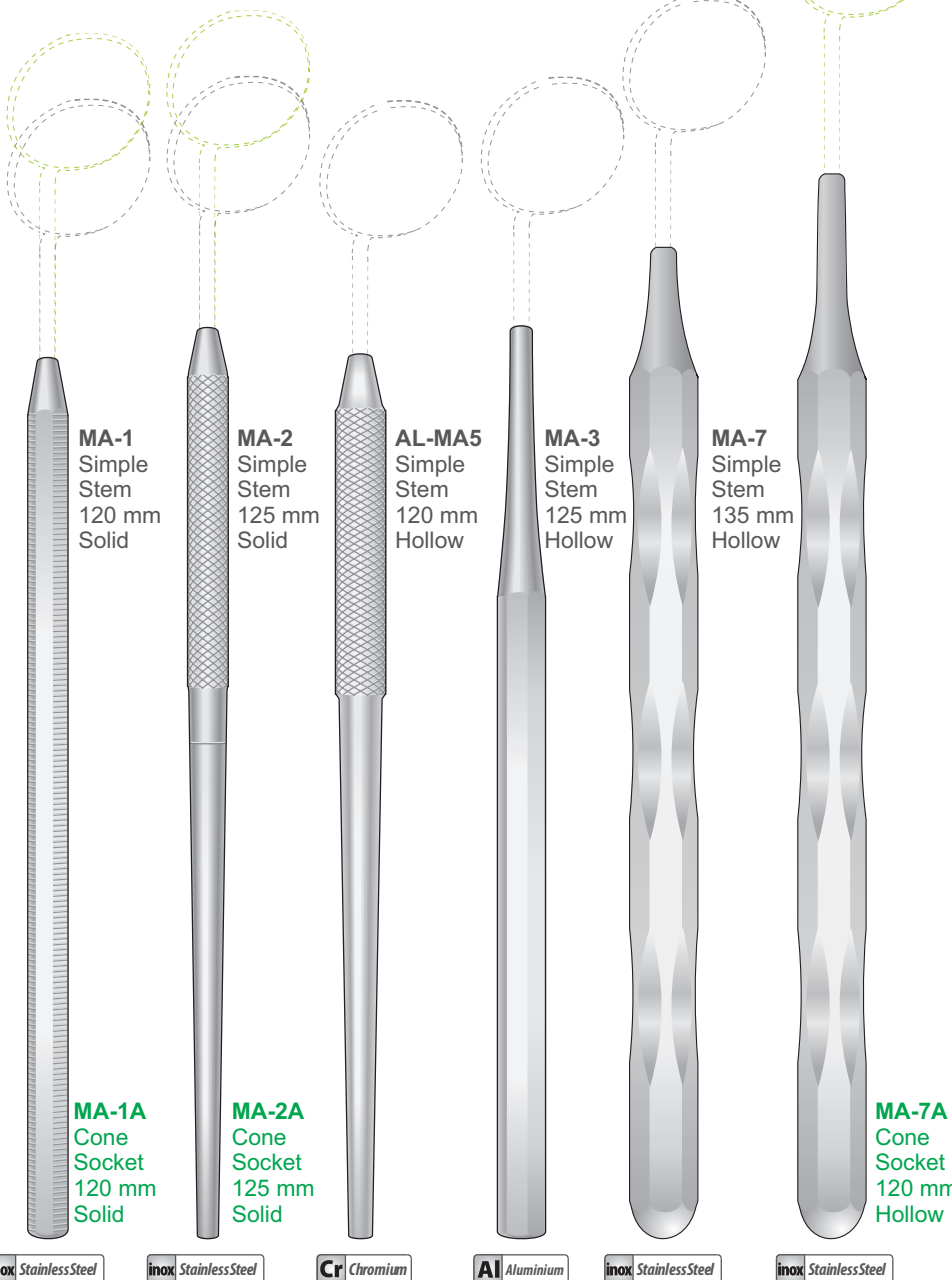

**MA-1**  
Simple Stem  
120 mm  
Solid

**MA-2**  
Simple Stem  
125 mm  
Solid

**AL-MA5**  
Simple Stem  
120 mm  
Hollow

**MA-3**  
Simple Stem  
125 mm  
Hollow

**MA-7**  
Simple Stem  
135 mm  
Hollow

**MA-1A**  
Cone Socket  
120 mm  
Solid

**MA-2A**  
Cone Socket  
125 mm  
Solid

**MA-7A**  
Cone Socket  
120 mm  
Hollow

inox StainlessSteel

inox StainlessSteel

Cr Chromium

Al Aluminium

inox StainlessSteel

inox StainlessSteel

## Mirrors and handles

Mundspiegel und Griffe  
Specchietti e manici  
Espejos y mangos  
Miroirs et manches

Spiegeldurchmesser - Diameter of mirrors  
Diametro dello specchio - Diamètre des miroirs  
Diámetro de los espejos

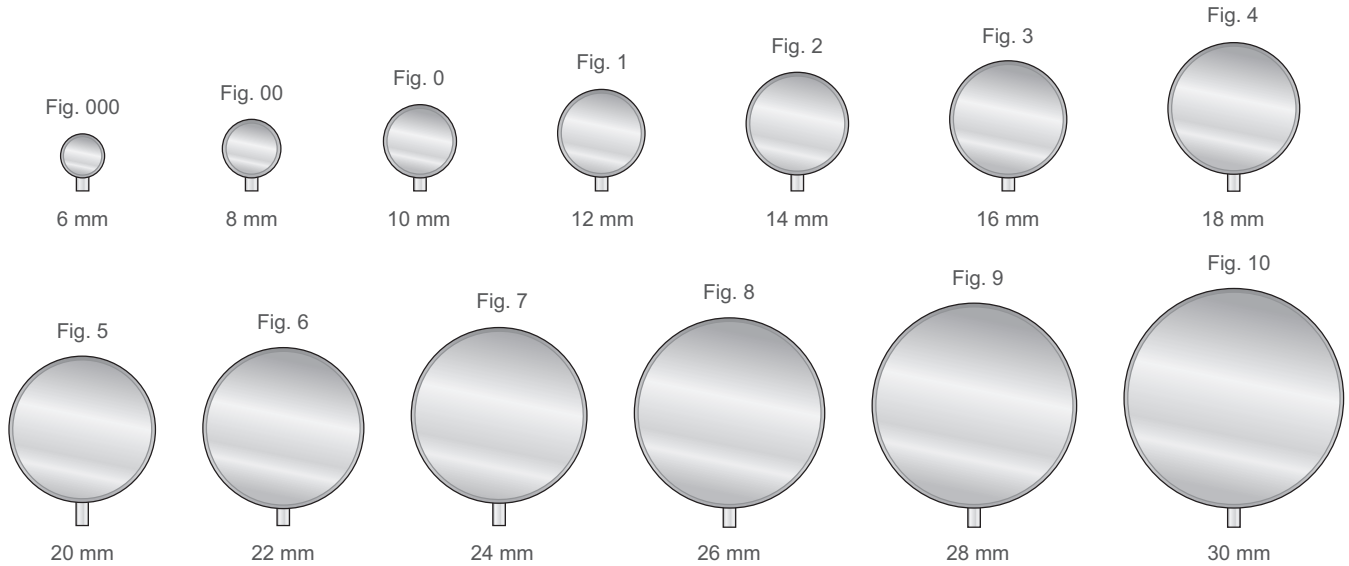

Inox

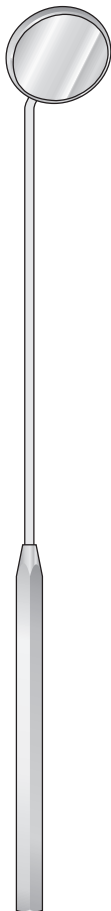

Kehlkopfspiegel mit  
Sechskantgriff  
Laryngeal mirrors  
with hexagonal handle  
Specchietto laringeo  
con manico esagonale  
Espejo laringeo  
con mango hexagonal  
Miroirs laryngiens  
avec manche hexagonal

**G-8** Fig. 00  
**G-10** Fig. 0  
**G-12** Fig. 1  
**G-14** Fig. 2  
**G-16** Fig. 3  
**G-18** Fig. 4  
**G-20** Fig. 5  
**G-22** Fig. 6  
**G-24** Fig. 7  
**G-26** Fig. 8  
**G-28** Fig. 9  
**G-30** Fig. 10

**G-8/G-30**  
180 mm

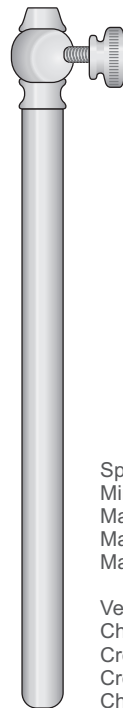

Spiegelgriff  
Mirrors handle  
Manico per specchietti  
Mango para espejos  
Manche à miroir

Verchromt  
Chromium  
Cromato  
Cromado  
Chromé

**MA-6**  
120 mm

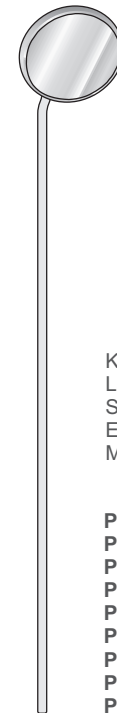

Kehlkopfspiegel  
Laryngeal mirrors  
Specchietto laringeo  
Espejos laryngiens  
Miroirs laryngiens

**P-000** Fig. 000  
**P-00** Fig. 00  
**P-0** Fig. 0  
**P-01** Fig. 1  
**P-02** Fig. 2  
**P-03** Fig. 3  
**P-04** Fig. 4  
**P-05** Fig. 5  
**P-06** Fig. 6

**P-000/P-06**  
120 mm

## Dental Syringes

Dental-Spritzen  
Siringhe dentali  
Jeringas dentales  
Seringues dentaires

## Periodontics / Endodontics / Restoration

Parodontologie / Endodontie / Restauration  
Parodontie / Endodontie / Restauration  
Parodontologia / Endodonzia / Restauro  
Parodontologiya / Endodontiya / Restavratsiya

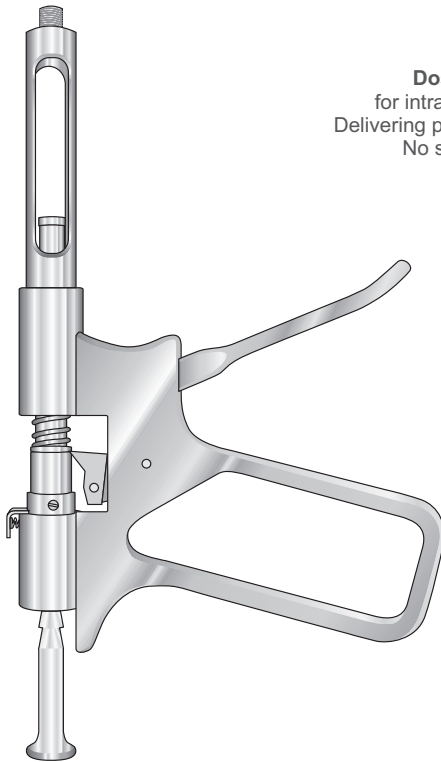

**Dosing Lever Syringe**  
for intraligamentary anesthesia.  
Delivering precisely 0.2 ml of anesthetic.  
No soft-tissue numbness.

- SD-7**  
Imperial Tip  
1.8 ml
- SD-7M**  
Metric Thread  
1.8 ml
- SD-9NA**  
Imperial Tip  
1.8 ml  
(Sold only in North America)

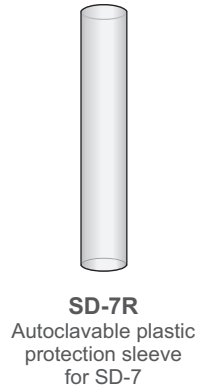

**SD-7R**  
Autoclavable plastic protection sleeve for SD-7

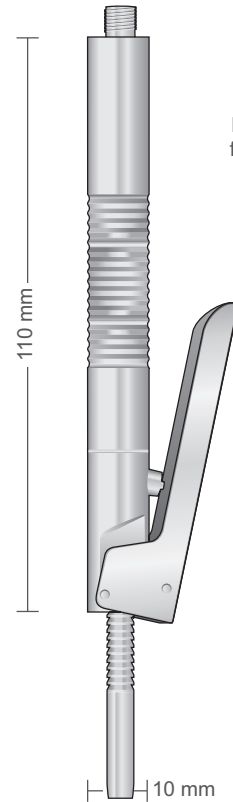

**Pen-style Syringe**  
for intraligamentary anesthesia

- SD-20**  
Imperial Tip  
1.8 ml
- SD-20M**  
Metric Thread  
1.8 ml

### Aspirating Anesthetic Syringe

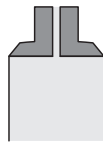

Aspirating syringes feature a blunt harpoon rod.

Lightweight and Ergonomic.

High quality stainless steel.

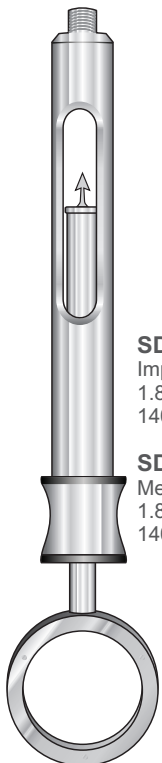

**SD-8**  
Imperial Tip  
1.8 ml  
140mm

**SD-8M**  
Metric Thread  
1.8 ml  
140mm

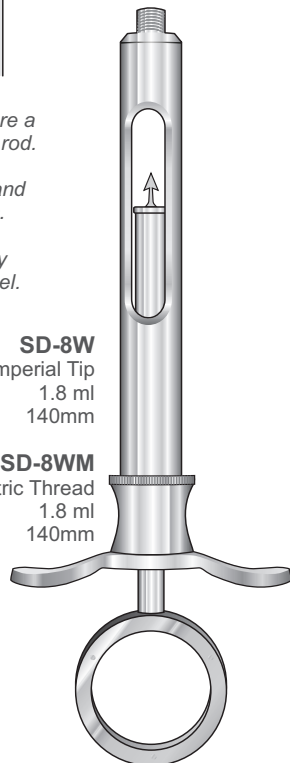

**SD-8W**  
Imperial Tip  
1.8 ml  
140mm

**SD-8WM**  
Metric Thread  
1.8 ml  
140mm

### Aspirating and Self Aspirating Anesthetic Syringe

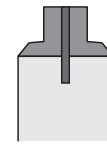

Self-aspirating mechanism allows to aspirate by means of counter pressure.

Lightweight and Ergonomic.

High quality stainless steel.

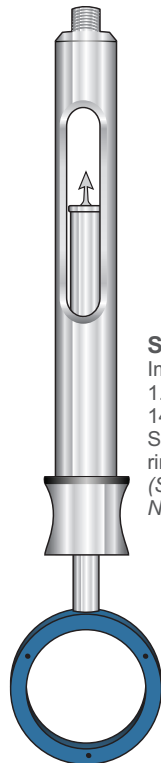

**SD-8NA**  
Imperial Tip  
1.8 ml  
140mm  
Silicone covered ring handle  
(Sold only in North America)

Silicone covered ring handle

### Self Aspirating Anesthetic Syringe

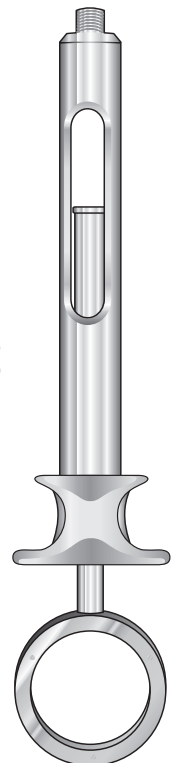

**SD-88**  
Imperial Tip  
1.8 ml  
140mm

**SD-88M**  
Metric Thread  
1.8 ml  
140mm

## Dental Syringes

Dental-Spritzen  
Siringhe dentali  
Jeringas dentales  
Seringues dentaires

Zylinder-Ampullen Spritzen  
Cartridge Syringes  
Siringhe per tubofiale  
Jeringas de ampollas  
Seringues d'ampoules

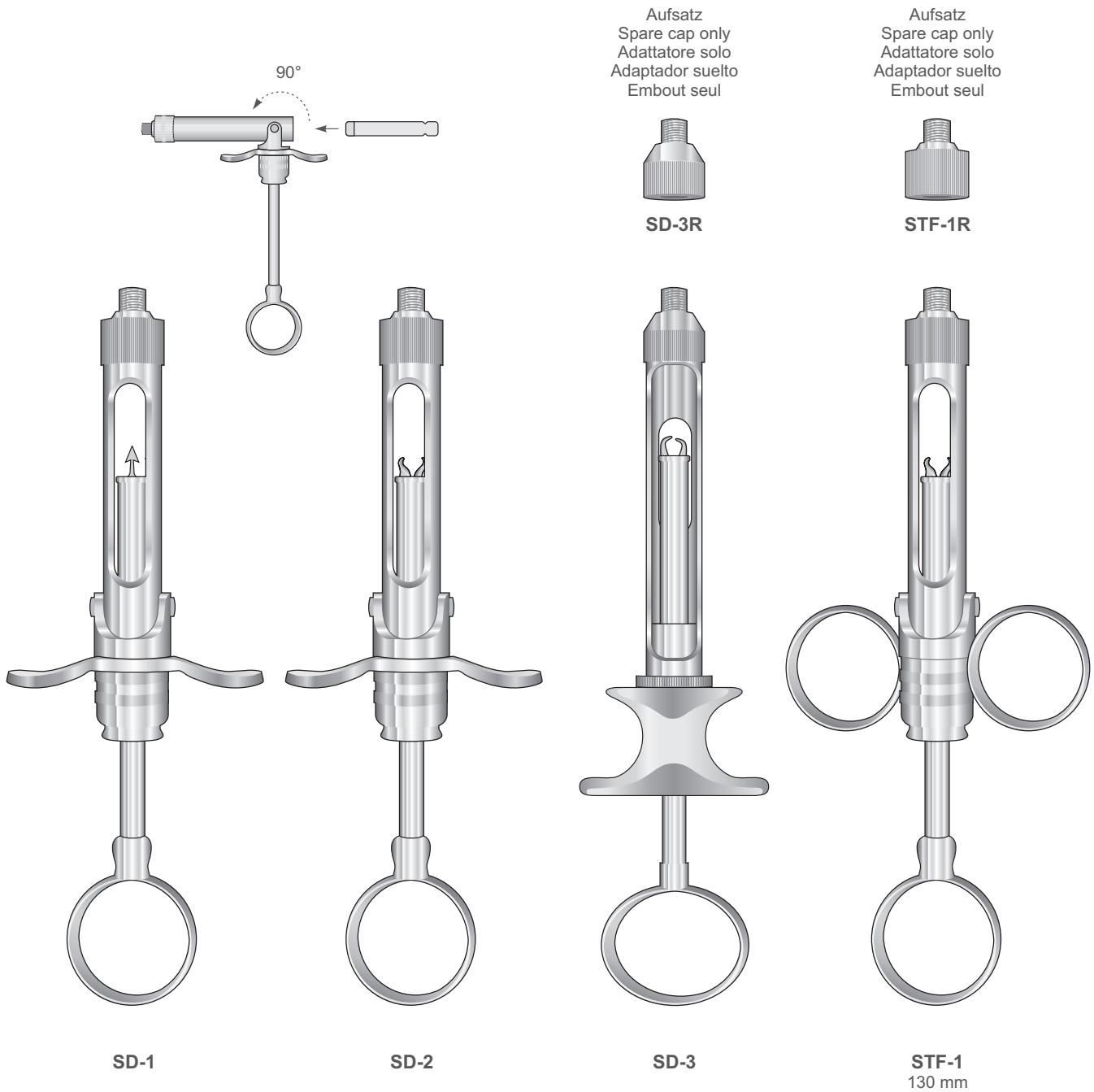

## Curettes

Küretten  
Curette  
Curetas  
Curettes

## Periodontics / Endodontics / Restoration

Parodontologie / Endodontie / Restauration  
Parodontie / Endodontie / Restauration  
Parodontologia / Endodonzia / Restauo  
Parodontologiya / Endodontiya / Restavratsiya



GRACEY  
CU-1/2



GRACEY  
CU-3/4



GRACEY  
CU-5/6



GRACEY  
CU-7/8



GRACEY  
CU-9/10



GRACEY  
CU-11/12



GRACEY  
CU-13/14

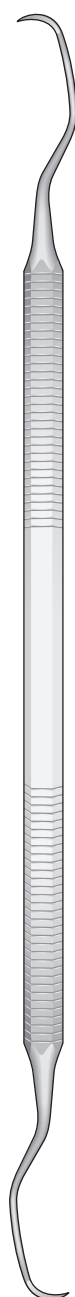

LANGER Fig. 1/2  
COL-1/2



LANGER Fig. 3/4  
COL-3/4



COLUMBIA  
COL-2RL

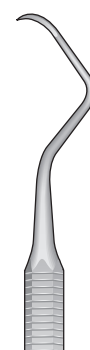

COLUMBIA  
COL-4RL



COLUMBIA  
COL-13/14

## Scalers and Curettes

Scaler und Küretten

Scaler e Curette

Raspadores y Curetas

Détartreurs et Curettes

**Curettes**

- Universal Tip 90°
- Gracey Tip 70°

Cutting Edges

*Elite*

**inox Stainless Steel**

Balanced and ergonomic for great tactile working ability. Maintains long sharp edges.  
Extra light hollow handle for optimum comfort (feather weight / round Ø 9 mm).

**Scalers**

- Curved Blade
- Tip 90°
- Straight Blade

Cutting Edges

Ausgewogen und ergonomisch für eine gute Anwendbarkeit.  
Dauerhafte scharfe Ecken. Extra leichte Hohlgriffe für optimale Komfort (Federleicht).

Équilibrés et ergonomiques pour une plus grande habileté tactile. Bords tranchants durables. Manche extra léger et creux pour un confort optimal (poids plume).

**Gracey Hygiene Chart**

UPPER LOWER

Anterior Posterior Molars Premolars (bicuspids) Canines (cuspid) Incisors

Canines (cuspid) Premolars (bicuspids) Molars

Equilibrado y ergonómico para mayor una facilidad de táctil. Bordes afilados durables. Mango hueco ultra-liviano para un confort óptimo (peso pluma).

Bilanciata ed ergonomiche per una maggiore facilità di lavoro. Bordi taglienti durevoli. Impugnatura cava, extra leggera, per un confort ottimale (peso piuma).

● Anterior: 1/2, 3/4, 5/6 ● Buccal Lingual Surfaces: 7/8, 9/10 ● Mesial Surfaces Premolars, Molars: 11/12, 15/16 ● Distal Surfaces Premolars, Molars: 13/14, 17/18

Also available: **ET**: Extra-Thin (micro), **S**: Small (mini S) and **L**: Long (after S)



**USG-1/2ET**  
Gracey  
Curette 1/2ET



**USG-3/4ET**  
Gracey  
Curette 3/4ET



**USG-5/6ET**  
Gracey  
Curette 5/6ET



**USG-7/8ET**  
Gracey  
Curette 7/8ET



**USG-9/10ET**  
Gracey  
Curette 9/10ET



**USG-11/12ET**  
Gracey  
Curette 11/12ET



**USG-13/14ET**  
Gracey  
Curette 13/14ET



**USG-15/16ET**  
Gracey  
Curette 15/16ET

## Scalers and Curettes

Scaler und Küretten  
Scaler e Curette  
Raspadores y Curetas  
Détartreurs et Curettes

## Periodontics / Endodontics / Restoration

Parodontologie / Endodontie / Restauration  
Parodontie / Endodontie / Restauration  
Parodontologia / Endodonzia / Restauro  
Parodontologiya / Endodontiya / Restavratsiya



**USG-1/2**  
Gracey  
Curette 1/2



**USG-3/4**  
Gracey  
Curette 3/4



**USG-5/6**  
Gracey  
Curette 5/6



**USG-7/8**  
Gracey  
Curette 7/8



**USG-9/10**  
Gracey  
Curette 9/10



**USG-11/12**  
Gracey  
Curette 11/12



**USG-13/14**  
Gracey  
Curette 13/14



**USG-1/2S**  
Gracey  
Curette 1/2S



**USG-3/4S**  
Gracey  
Curette 3/4S



**USG-5/6S**  
Gracey  
Curette 5/6S



**USG-7/8S**  
Gracey  
Curette 7/8S



**USG-9/10S**  
Gracey  
Curette 9/10S



**USG-11/12S**  
Gracey  
Curette 11/12S



**USG-13/14S**  
Gracey  
Curette 13/14S





## Scalers and Curettes

Scaler und Küretten

Scaler e Curette

Raspadores y Curetas

Détartreurs et Curettes

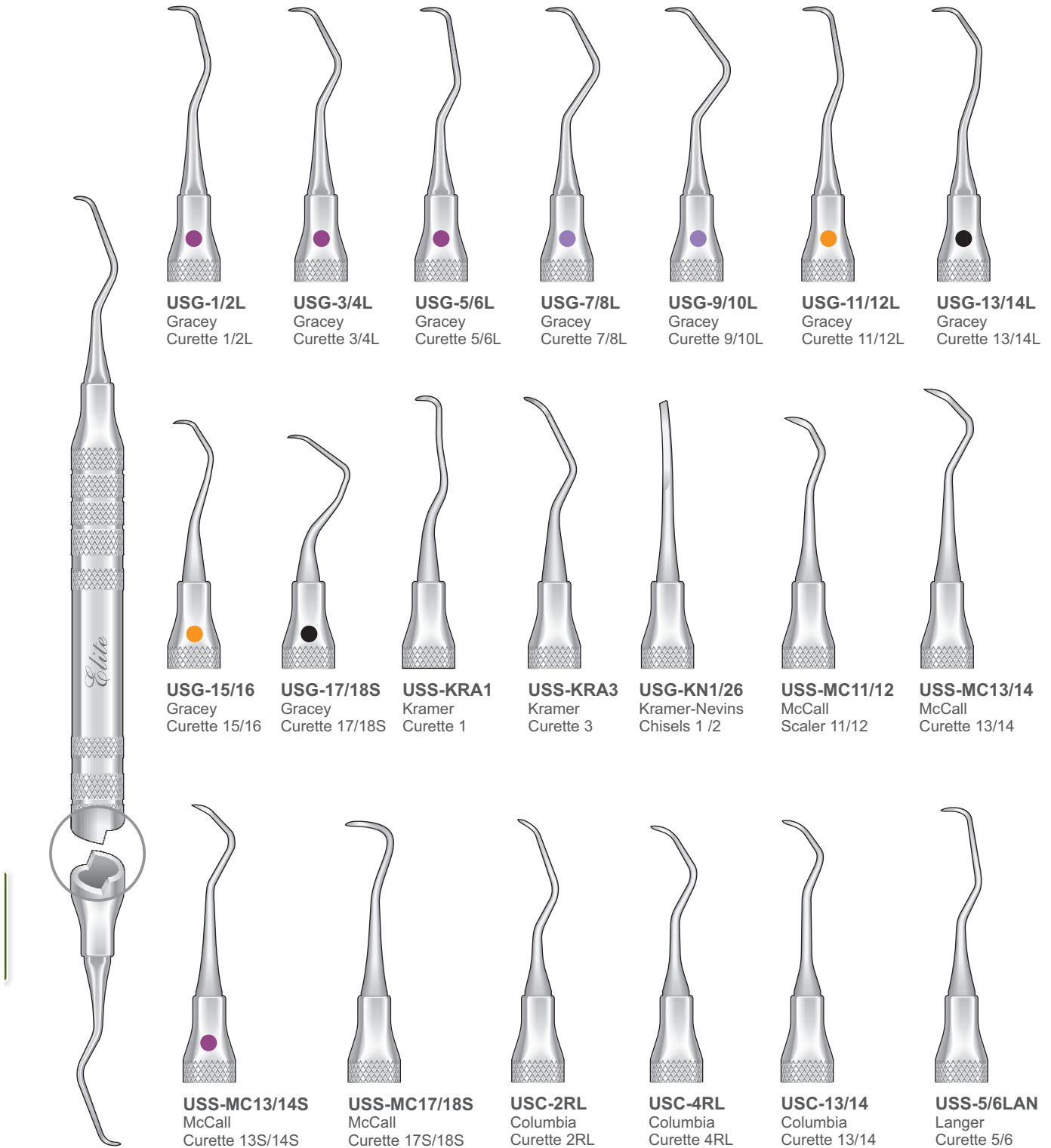

## Scalers and Curettes

Scaler und Küretten  
Scaler e Curette  
Raspadores y Curetas  
Détartreurs et Curettes

## Periodontics / Endodontics / Restoration

Parodontologie / Endodontie / Restauration  
Parodontie / Endodontie / Restauration  
Parodontologia / Endodonzia / Restauro  
Parodontologiya / Endodontiya / Restavratsiya



**USS-NV0**  
Nevi  
Scaler  
Nv0



**USS-NV11/12**  
Nevi  
Scaler  
NV11/12



**USS-NV13/14**  
Nevi  
Scaler  
NV13/14



**USS-T2/3**  
Taylor  
Scaler 2/3



**USS-204S**  
Scaler  
204S



**USS-H6/7**  
Scaler  
H6/H7



**USS-15/33**  
Towner-Jaquette  
Scaler  
U15/J33



**USS-5/33**  
Jaquette  
Scaler  
H5/J33



**USS-15/30**  
Towner-Jaquette  
Scaler  
U15/J30



**USS-J14/15**  
Jaquette  
Scaler  
J14/15



## Scalers and Curettes

Scaler und Küretten  
Scaler e Curette  
Raspadores y Curetas  
Détartreurs et Curettes

**Curettes**

- Universal Tip 90°
- Gracey Tip 70°
- Cutting Edges

*Elite*  
**TITANIUM**

Long lasting solid titanium tip. Designed for removing calculus on implants surfaces. Gold coloured handle for easy identification purposes so they won't be mixed up with standard stainless instruments (feather weight / round Ø 9 mm).

**Scalers**

- Curved Blade
- Straight Blade
- Tip 90°
- Cutting Edges

*Massivem Titan-Spitzen dass sie extrem widerstandsfähig und langlebig sind. Entwickelt für die Entfernung von Zahnbelag auf Implantat Oberflächen. Vergoldete Griff für eine einfache Kennzeichnung damit sie von Standard Instrumenten unterschieden werden können (Federleicht).*

*Pointes en titane solide plus résistantes et durables. Développées pour l'enlèvement du tartre sur les implants en titane. Manche de couleur or pour une meilleure identification. Ceci permet de ne pas les confondre avec les instruments communs en acier inoxydable (poids plume).*

**Gracey Hygiene Chart**

UPPER LOWER

Posterior Molars Premolars (bicuspid) Canines (cuspid) Anterior Incisors

*Puntas de titanio sólido más resistentes y durables. Diseñado para eliminar el sarro en los implantes de titanio. Mango dorado para una mejor identificación, el cual evita la confusión con los instrumentos de acero inoxidable estándar (peso pluma).*

*Punte in titanio solido più resistente e durevole. Progettate per la rimozione di tartaro dalle superfici degli impianti. Manico color oro per un riconoscimento semplice e per evitare di essere confuse con i strumenti in acciaio (peso piuma).*

● Anterior: 1/2, 3/4, 5/6 ● Buccal Lingual Surfaces: 7/8, 9/10 ● Mesial Surfaces Premolars, Molars: 11/12, 15/16 ● Distal Surfaces Premolars, Molars: 13/14, 17/18

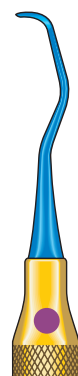

**T-USG-1/2**  
Gracey  
Curette 1/2



**T-USG-5/6**  
Gracey  
Curette 5/6

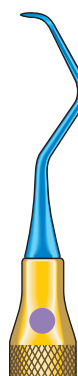

**T-USG-7/8**  
Gracey  
Curette 7/8



**T-USG-11/12**  
Gracey  
Curette 11/12



**T-USG-13/14**  
Gracey  
Curette 13/14

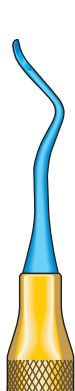

**T-USS-B5/6**  
Barnhart  
Curette 5/6

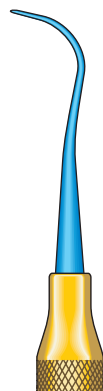

**T-USS-YG7/8**  
Younger-Good  
Curette YG 7/8



**T-USS-204S**  
Scaler 204S

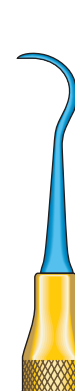

**T-USS-G6/7**  
Scaler G6/G7

Use a dedicated sharpening stone for Titanium Scalers & Curettes.

## Curettes - Files

Curette - Lima  
 Curetasc - Lima  
 Curettes - Limes  
 Curettes - Limes

## Periodontics / Endodontics / Restoration

Parodontologie / Endodontie / Restauration  
 Parodontie / Endodontie / Restauration  
 Parodontologia / Endodonzia / Restauro  
 Parodontologiya / Endodontiya / Restavratsiya

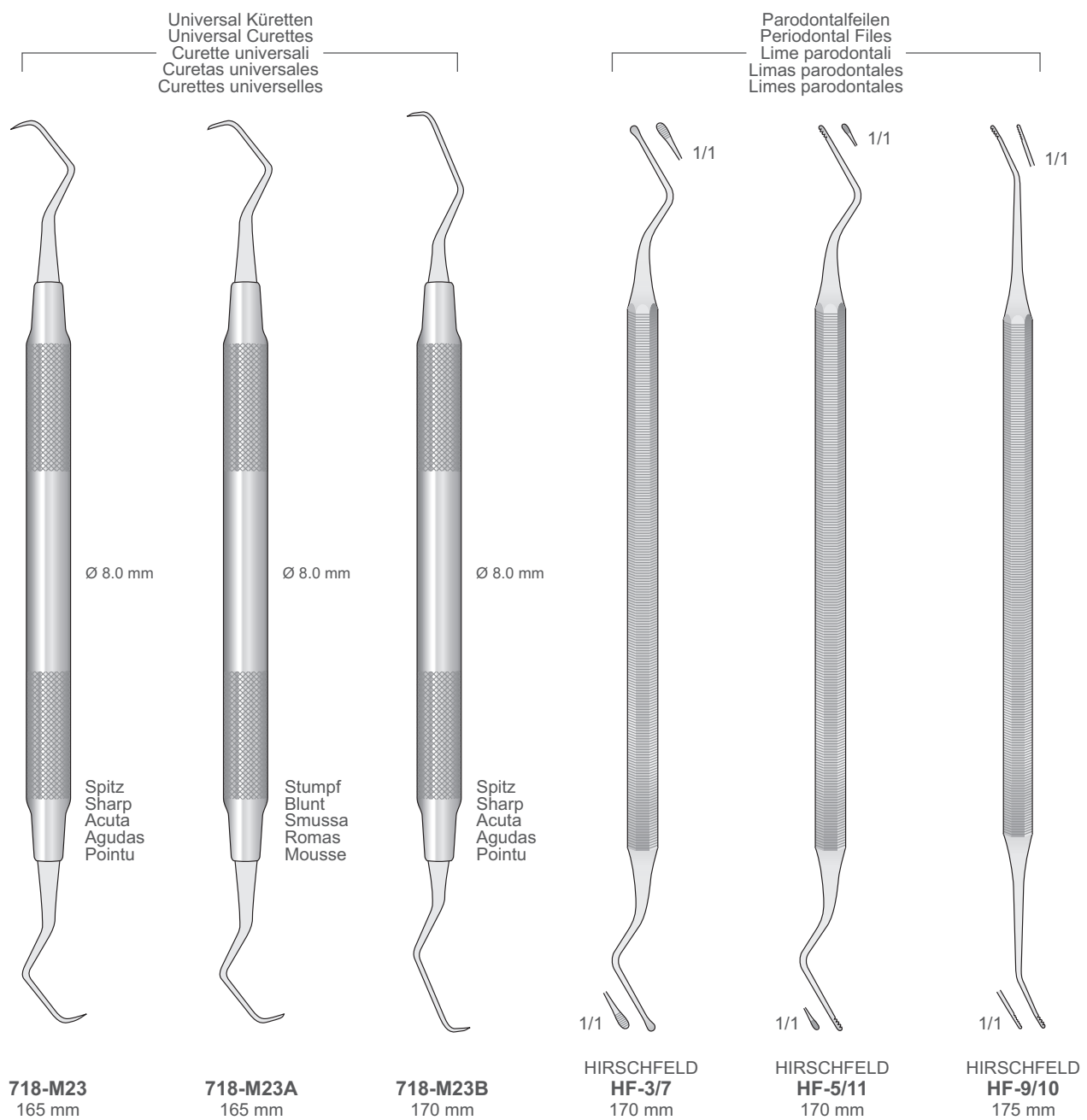

## Scalers

Scaler  
Ablatori di tartaro  
Limpiadores  
Détartreurs

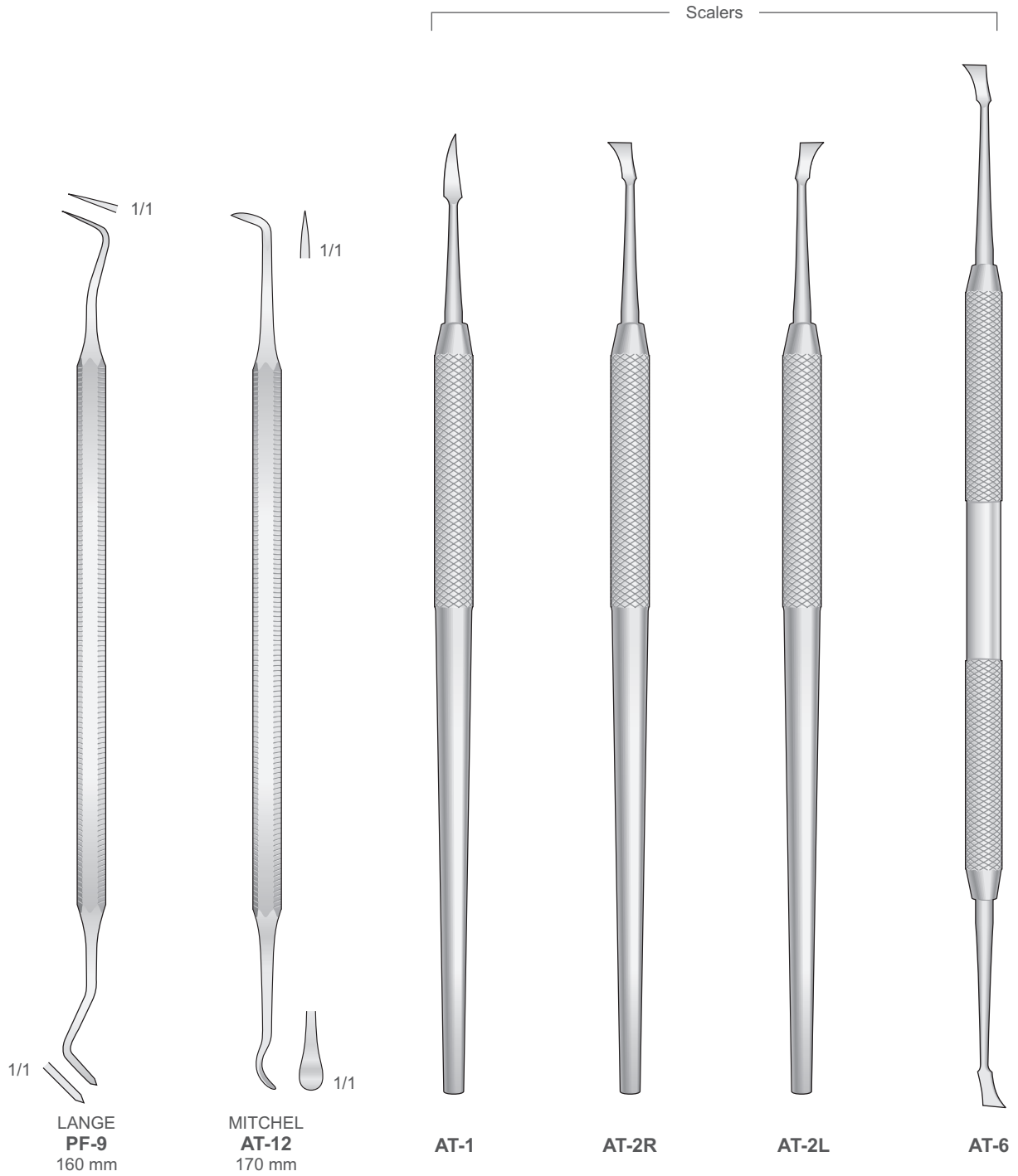

## Amalgam gun for retrograde

Amalgampistole für retrograde  
Siringhe portamalgame retrogradi  
Portaamalgama para retrógradas  
Porte-amalgame pour rétrogrades

## Periodontics / Endodontics / Restoration

Parodontologie / Endodontie / Restauration  
Parodontie / Endodontie / Restauration  
Parodontologia / Endodonzia / Restauro  
Parodontologiya / Endodontiya / Restavratsiya

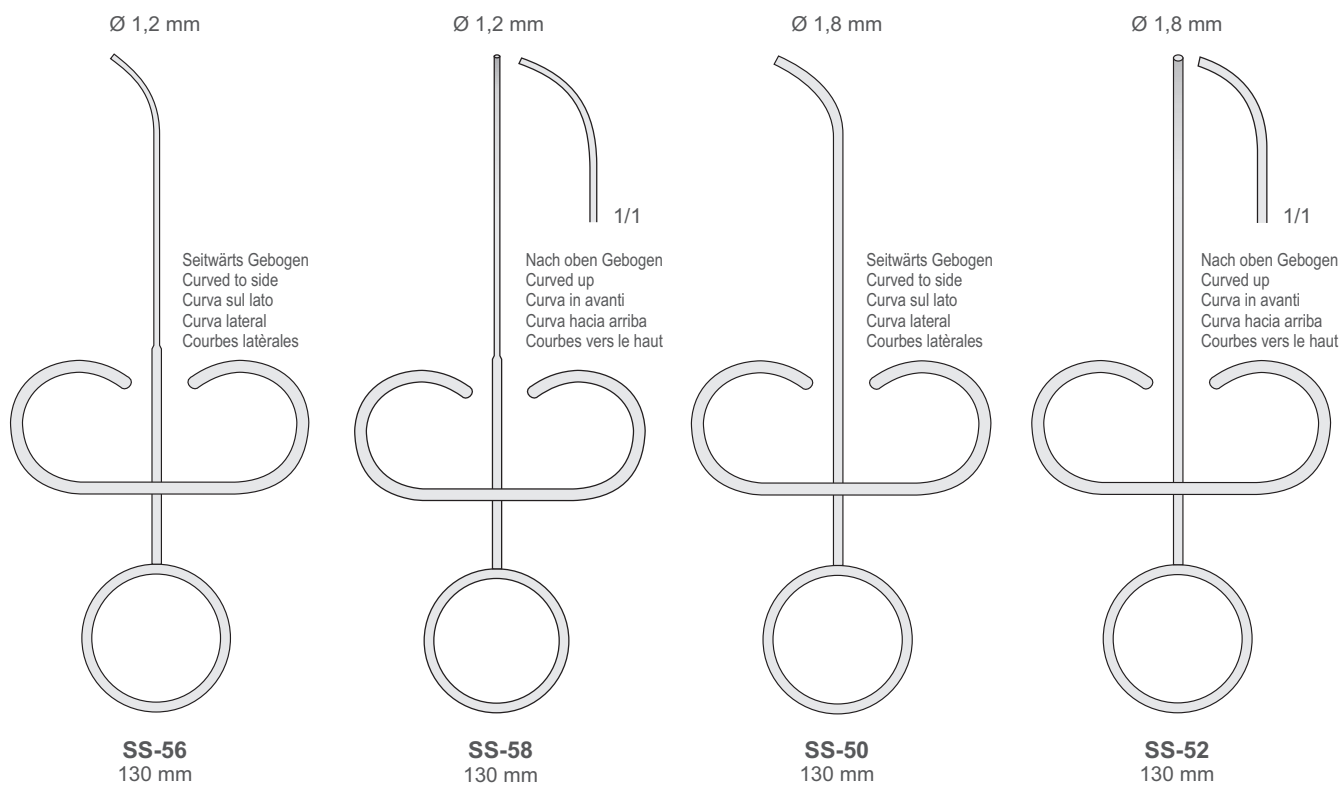
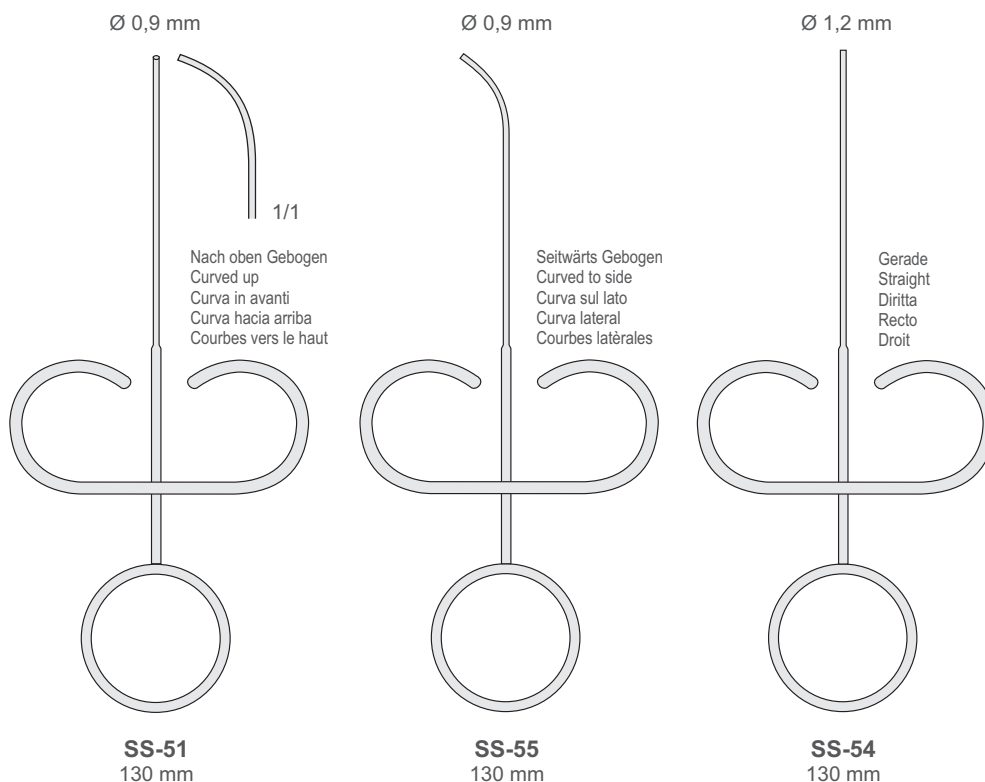

## Amalgam Carriers

Amalgamträger  
Porta amalgama  
Porta-amalgamas  
Porte-amalgames

inox StainlessSteel

Amalgambecher  
Amalgam Well  
Mortaino per amalgama  
Vaso para amalgama  
Gobelet pour amalgame



Knochenschale  
Bone Well  
Bacinella per osso  
Cubeta para hueso  
Cuvette à os

**SS-65**

Ø 35 x 35mm  
depht 15 mm  
5cc - 0.17oz

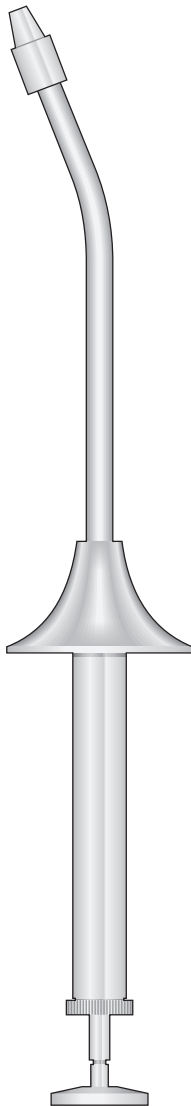

**SS-15**

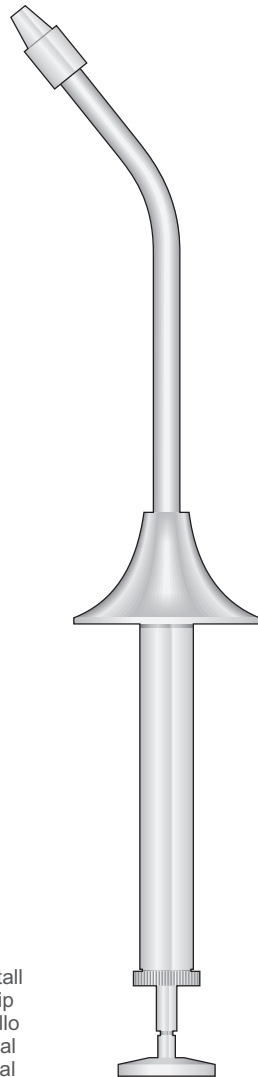

**SS-16**

Aus Metall  
Metal tip  
In metallo  
De metal  
En métal

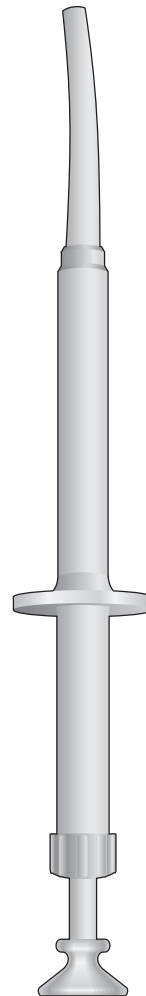

**SS-41**  
170 mm

Autoclavable  
Aus Kunststoff  
Plastic tip  
In plastica  
De plàstico  
En plastique

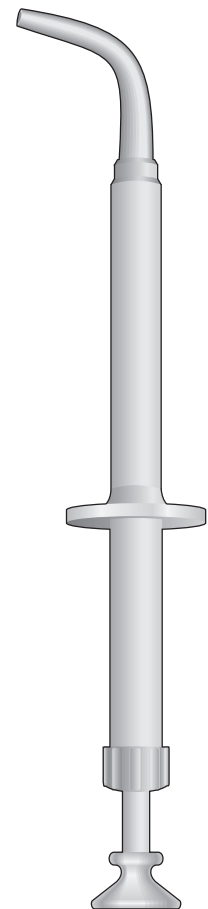

**SS-42**  
160 mm

## Composite Instruments

Kompositinstrumente  
Strumenti per composito  
Instrumentos para composites  
Instruments pour composites

## Periodontics / Endodontics / Restoration

Parodontologie / Endodontie / Restauration  
Parodontie / Endodontie / Restauration  
Parodontologia / Endodonzia / Restauro  
Parodontologiya / Endodontiya / Restavratsiya



Fig. FE1

Fig. FE2

Fig. FE3

Fig. FE4

Fig. FE5

Fig. FE6

Fig. GO1

Fig. GO2

Fig. GO3

Fig. GO4

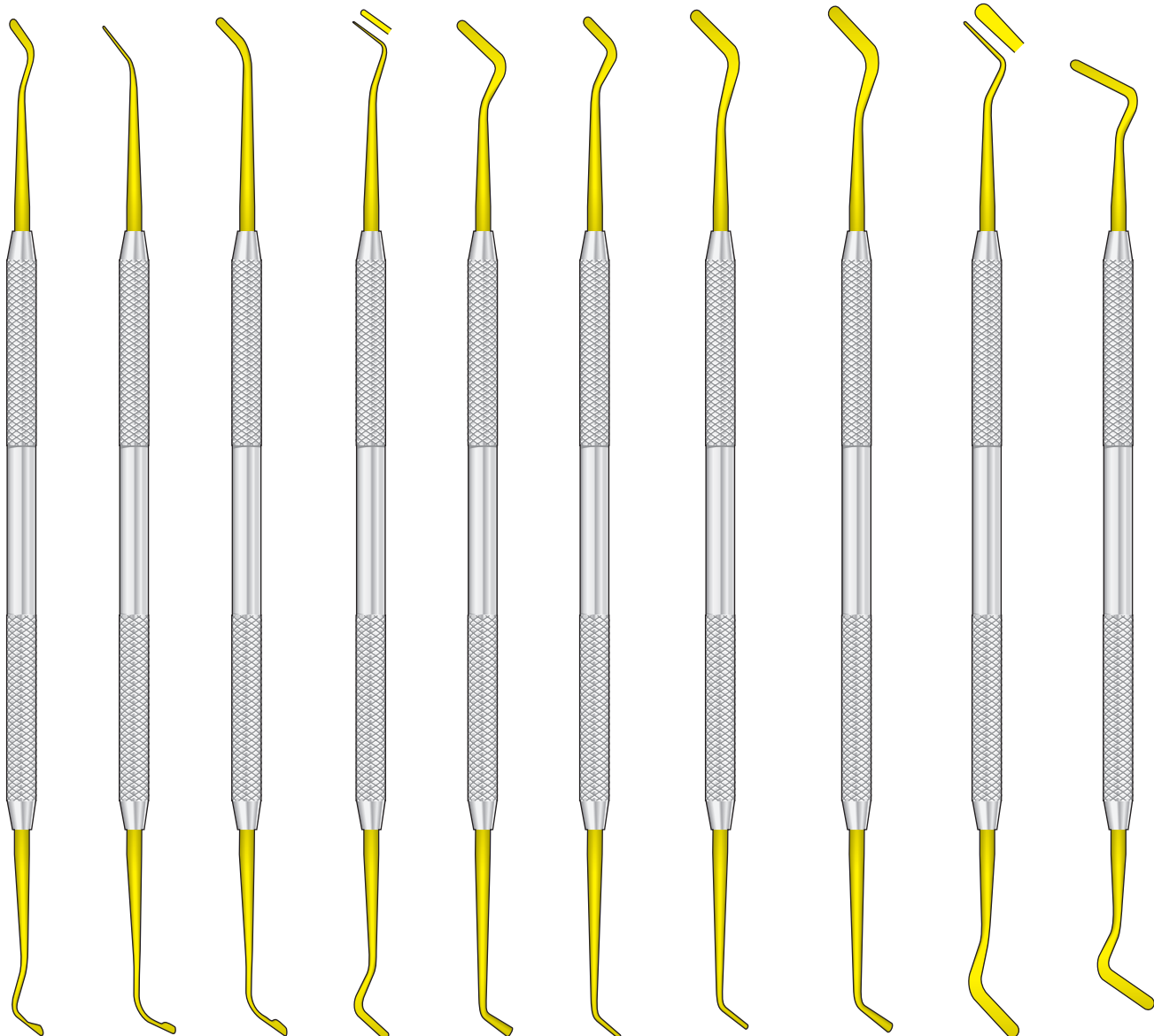

FELT  
OT-1

FELT  
OT-2

FELT  
OT-3

FELT  
OT-4

FELT  
OT-5

FELT  
OT-6

GOLDSTEIN  
OT-7

GOLDSTEIN  
OT-8

GOLDSTEIN  
OT-9

GOLDSTEIN  
OT-10



## Composite Instruments

Kompositinstrumente  
Strumenti per composito  
Instrumentos para composites  
Instruments pour composites



Titanium-coated  
Titan-beschichtet  
Recouvrement en Titane  
Recubrimiento de Titanio  
Ricoperto in Titanio

Fig. CP1  
1,5 mm



OT-11

Fig. CP2  
2,0 mm



OT-12

Fig. CP3  
2,0 mm

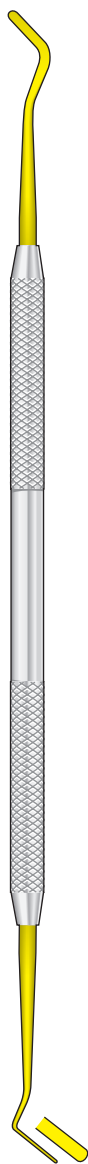

OT-13

Fig. CP4  
2,5 mm

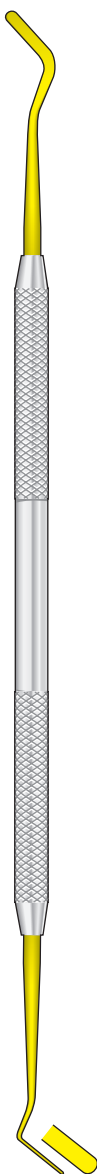

OT-14

Fig. CP5



OT-15

Fig. CP6



OT-16

## Composite Instruments

Kompositinstrumente  
Strumenti per composito  
Instrumentos para composites  
Instruments pour composites

## Periodontics / Endodontics / Restoration

Parodontologie / Endodontie / Restauration  
Parodontie / Endodontie / Restauration  
Parodontologia / Endodonzia / Restauro  
Parodontologiya / Endodontiya / Restavratsiya



FELT

GOLDSTEIN

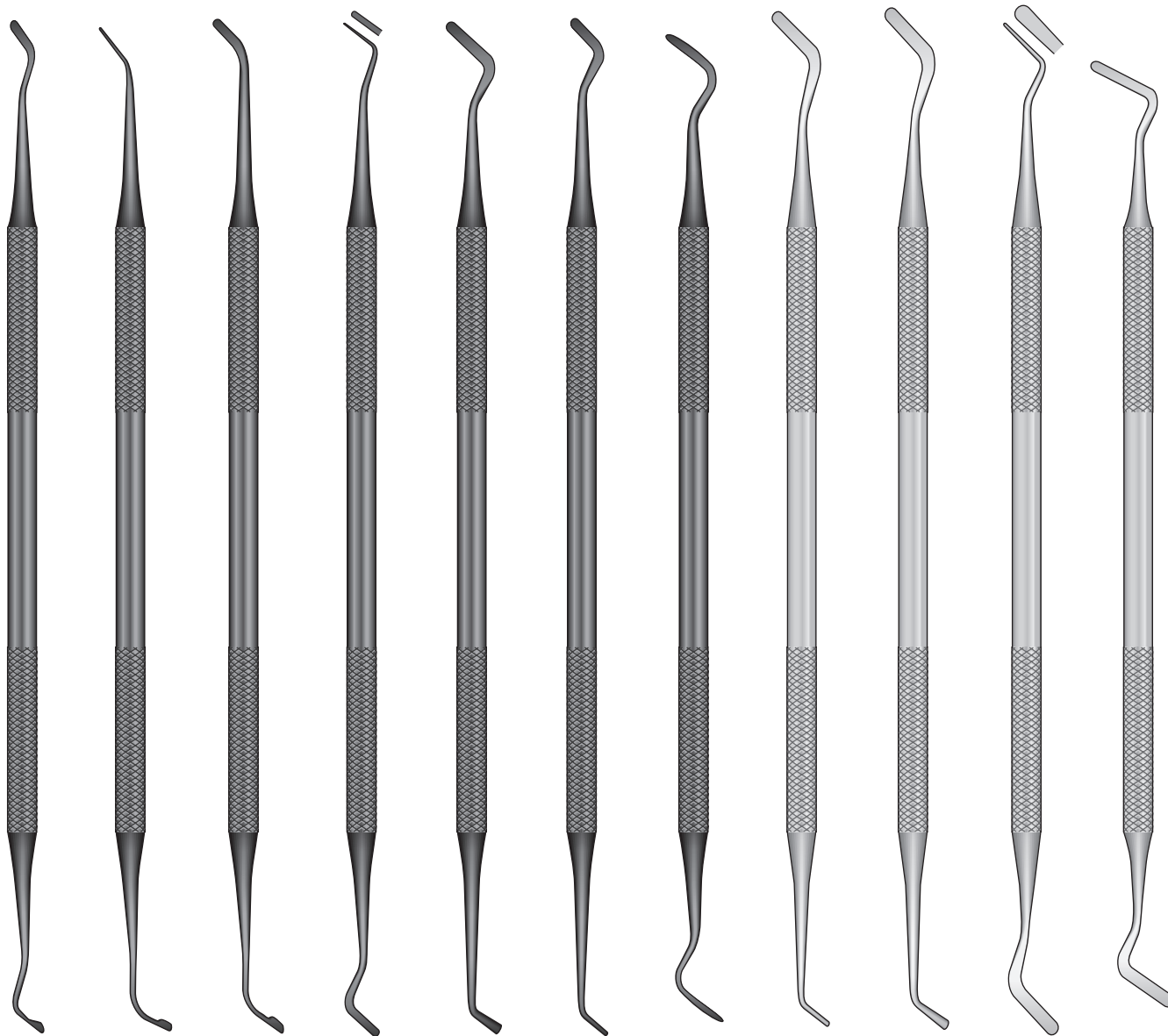

FE-1

FE-2

FE-3

FE-4

FE-5

FE-6

FE-4/5

GO-1

GO-2

GO-3

GO-4

## Cement Spatulas

Zementspatel

Spatole per cemento

Espátulas para cemento

Spatules à ciment

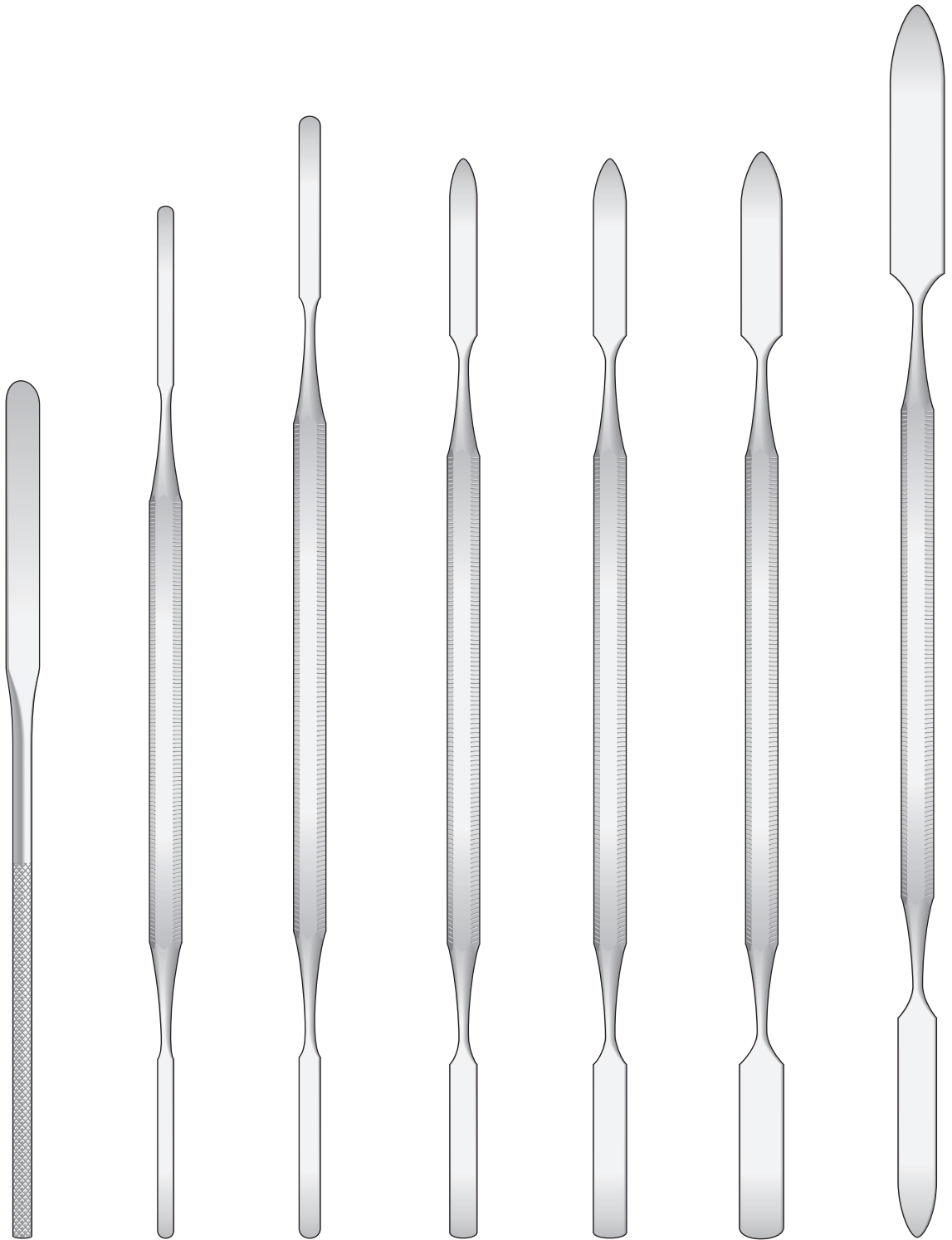

**SR**  
140 mm

**S-00**  
180 mm

**S-0**  
185 mm

**S-1**  
180 mm

**S-2**  
180 mm

**S-3**  
180 mm

**S-4**  
200 mm

## Filling Instruments

Füllungsinstrumente  
Strumenti per otturazione  
Instrumentos para obturación  
Instruments pour obturation

## Periodontics / Endodontics / Restoration

Parodontologie / Endodontie / Restauration  
Parodontie / Endodontie / Restauration  
Parodontologia / Endodonzia / Restauro  
Parodontologiya / Endodontiya / Restavratsiya

Heidemann-Spateln  
Heidemann Spatulas  
Spatole Heidemann  
Espátulas Heidemann  
Spatules Heidemann

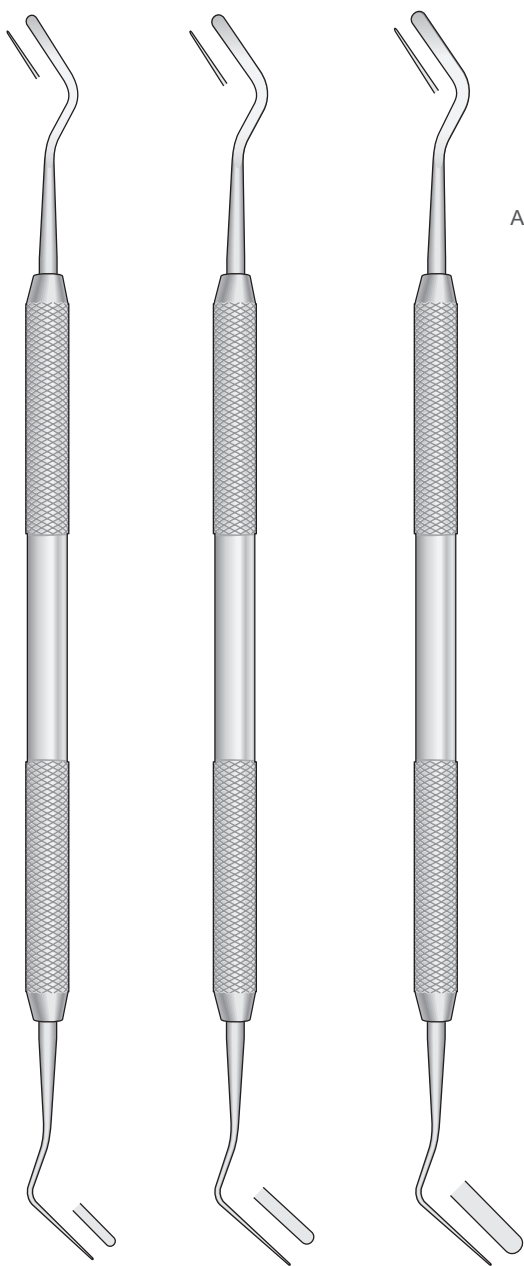

**H-1**  
Fig. 1

**H-2**  
Fig. 2

**H-3**  
Fig. 3

Dycal Applikator  
Placement Instrument  
Aplicatore per sottofondo  
Aplicadores de fondo  
de cavidades  
Applicateur de fond  
de cavité



**A-1**  
125 mm

Amalgam Instrumente  
Amalgam Carvers  
Strumenti per modellare l'amalgama  
Instrumentos para modelar las obturaciones  
Instruments à modeler l'amalgame

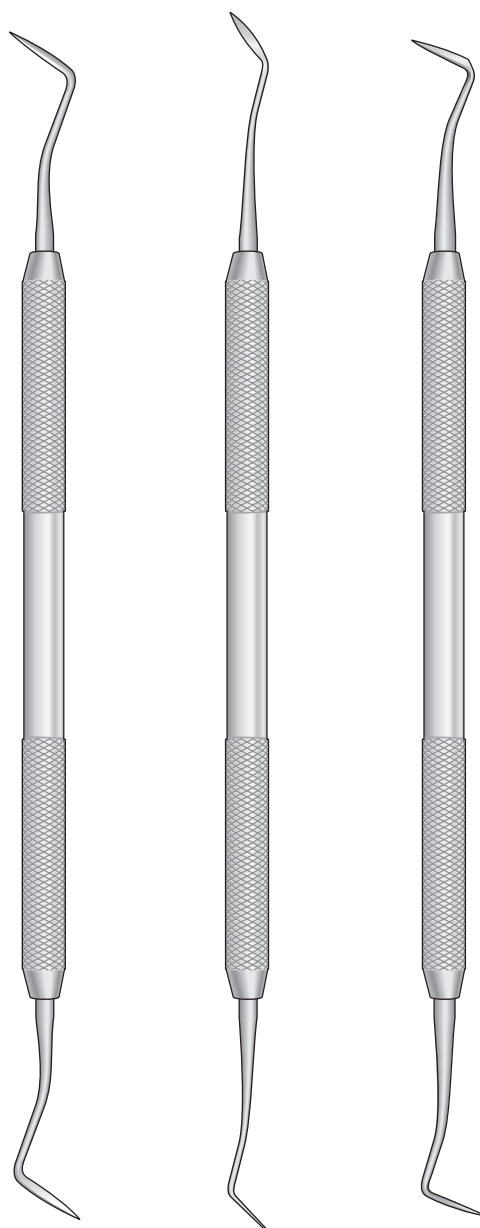

**R-1**  
HOLLENBACH  
# 1 - 165 mm

**R-2**  
HOLLENBACH  
# 1/2 - 165 mm

**R-3**  
HOLLENBACH  
# 3 - 165 mm

## Amalgam Carvers

Amalgam Instrumente

Strumenti per modellare l'amalgama

Instrumentos para modelar las obturaciones

Instruments à modeler l'amalgame

Instrument für Drahrückzug  
Instrument for retractor wire  
Strumento per filo retrattore  
Instrumento para hilo separador  
Instruments pour fil séparateur

Cleoids - Discoids

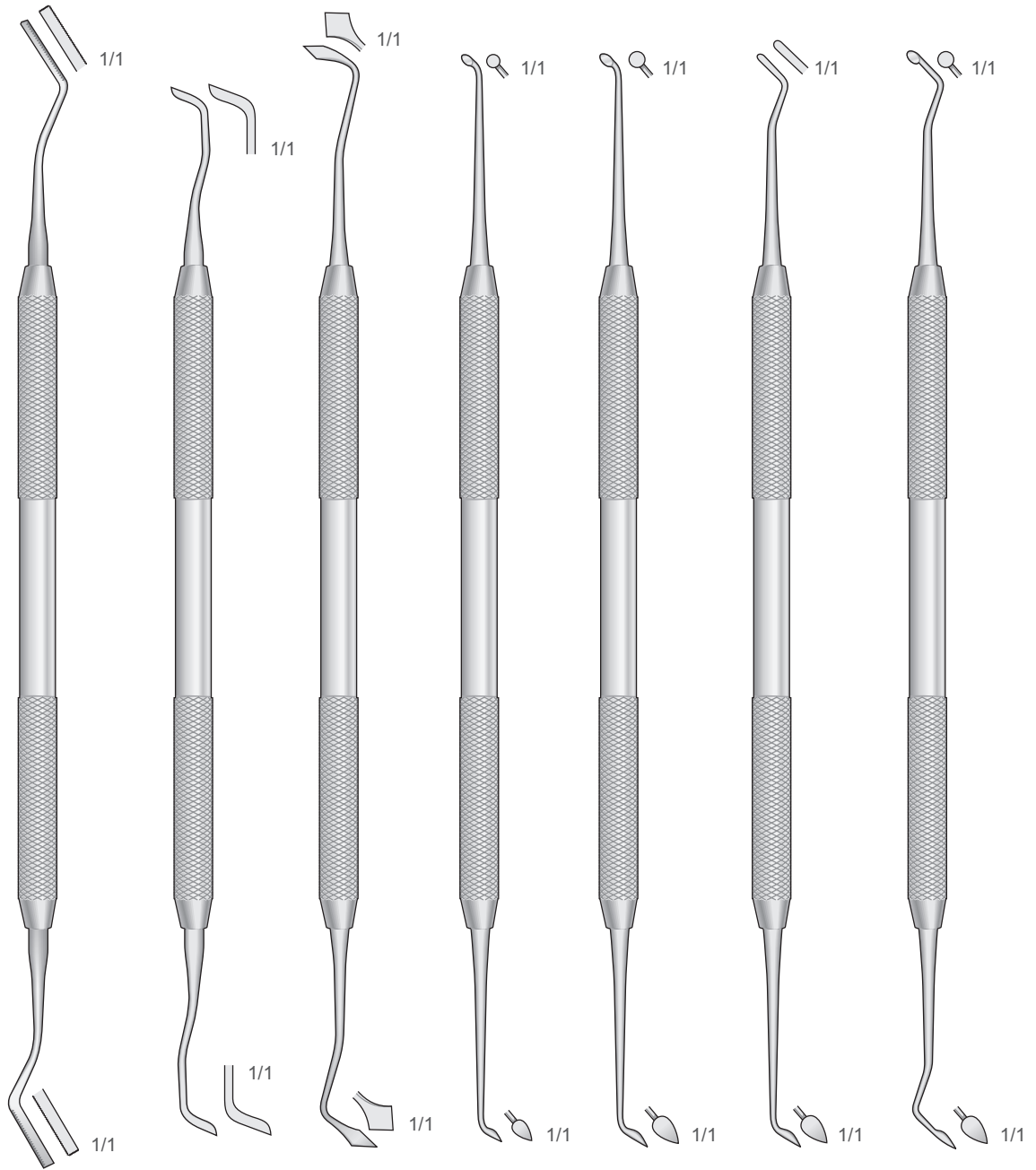

**CV-11**

**USC-2**  
USC

**F-2/3**  
FRAHM

**CD-1**  
Fig. 1/2

**CD-2**  
Fig. 4/5

**CD-3**  
Fig. W.A.C.D.

**CD-4**  
Fig. 3/6

## Filling Instruments

Füllungsinstrumente  
Strumenti per otturazione  
Instrumentos para obturación  
Instruments pour obturation

## Periodontics / Endodontics / Restoration

Parodontologie / Endodontie / Restauration  
Parodontie / Endodontie / Restauration  
Parodontologia / Endodonzia / Restauro  
Parodontologiya / Endodontiya / Restavratsiya

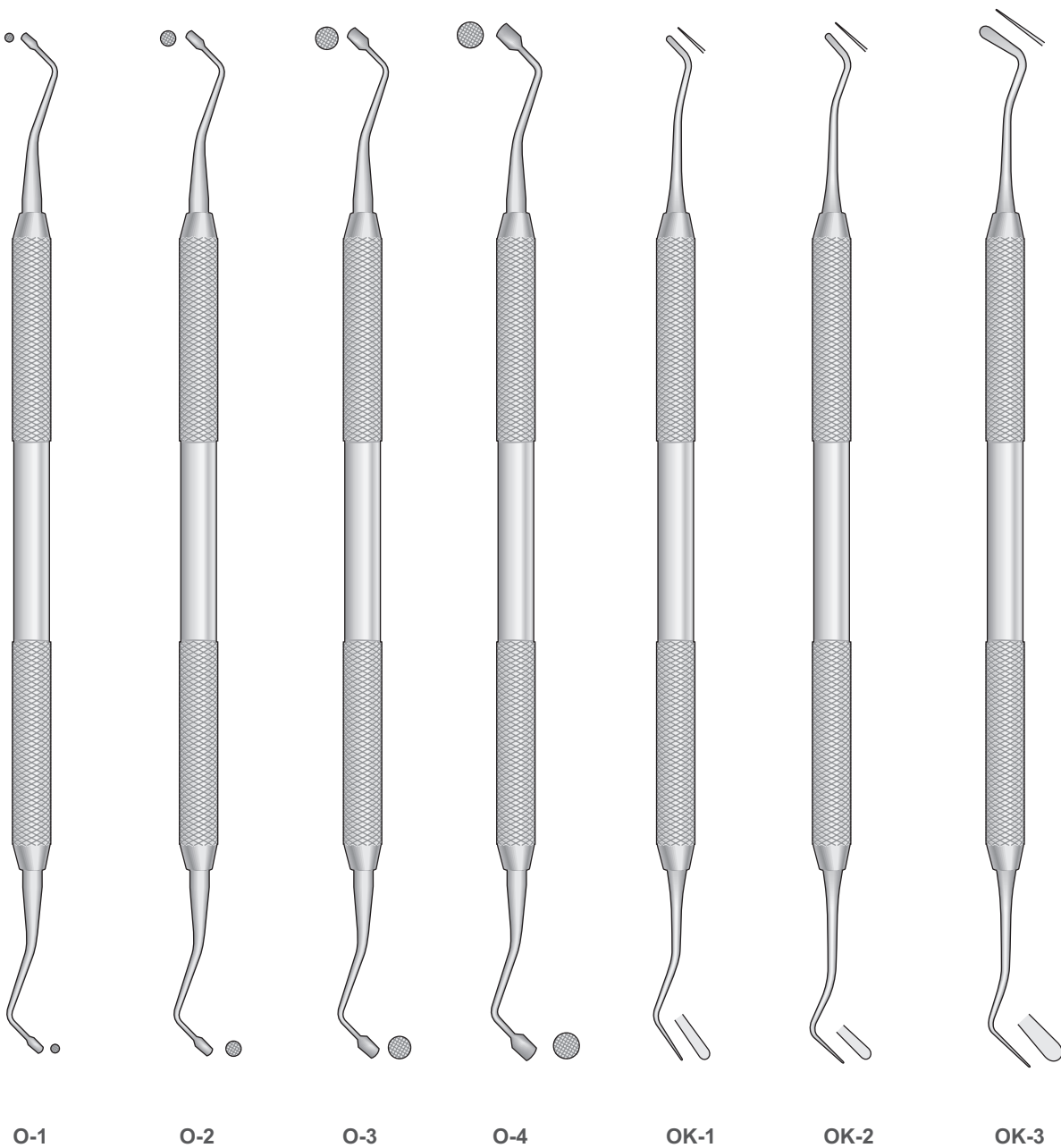

## Filling Instruments

Füllungsinstrumente

Strumenti per otturazione

Instrumentos para obturación

Instrumentos pour obturation

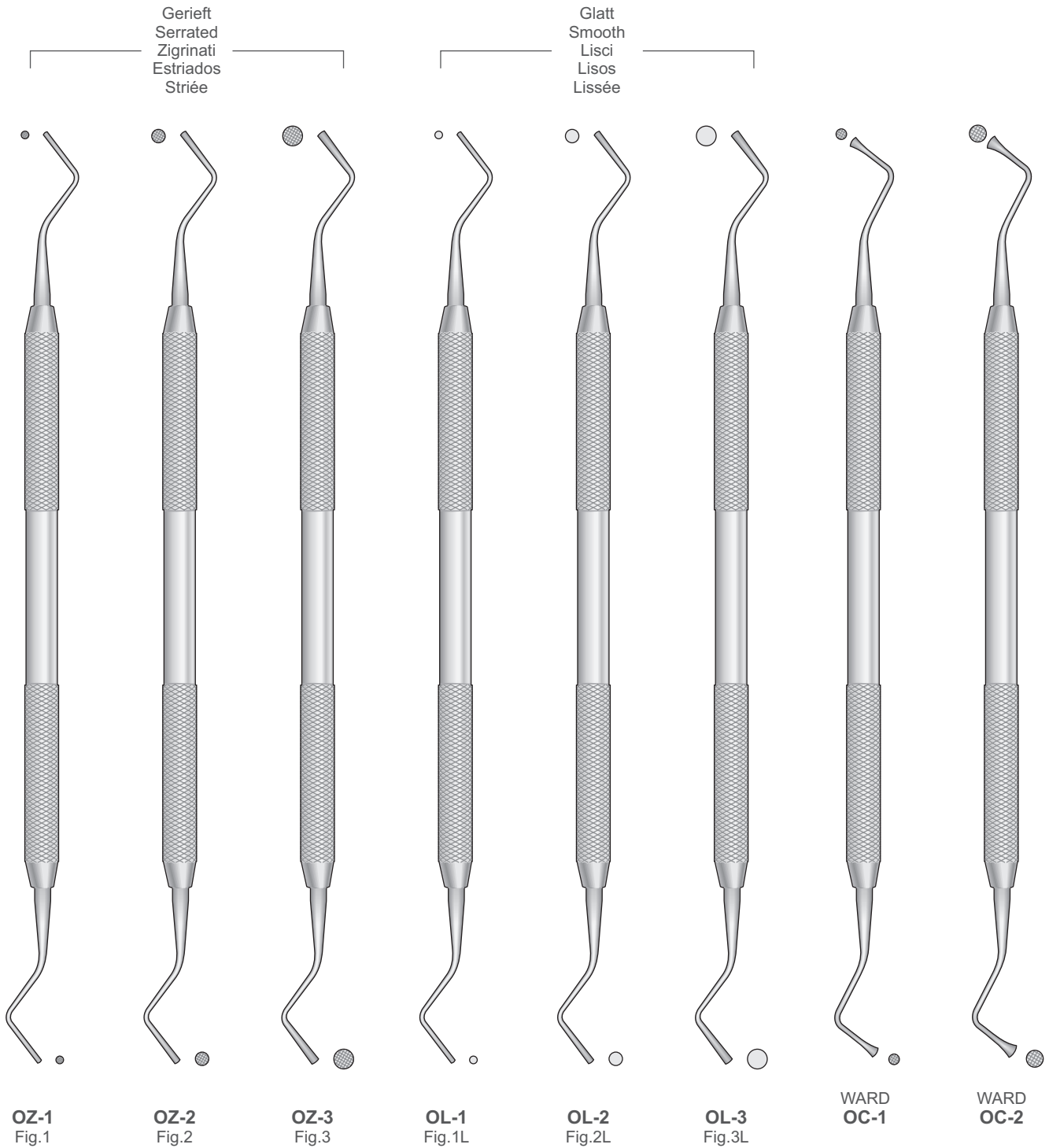

## Filling Instruments

Füllungsinstrumente  
Strumenti per otturazione  
Instrumentos para obturación  
Instruments pour obturation

## Periodontics / Endodontics / Restoration

Parodontologie / Endodontie / Restauration  
Parodontie / Endodontie / Restauration  
Parodontologia / Endodonzia / Restauro  
Parodontologiya / Endodontiya / Restavratsiya

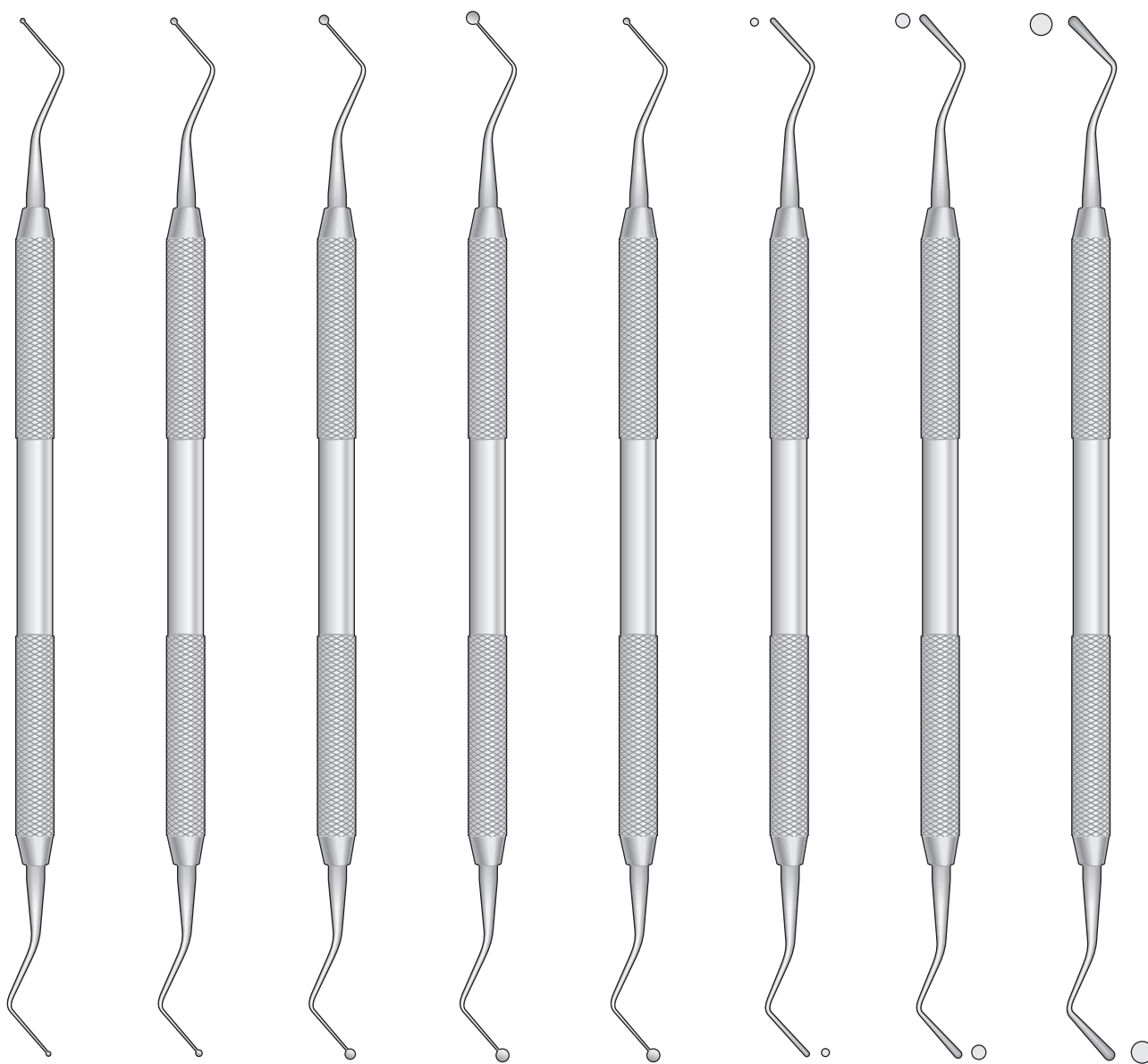

**OP-1**  
Fig.1

**OP-2**  
Fig.2

**OP-3**  
Fig.3

**OP-4**  
Fig.4

**OP-5**  
Fig.5

**OA-1**  
Fig.1

**OA-2**  
Fig.2

**OA-3**  
Fig.3



## Filling Instruments

Füllungsinstrumente  
Strumenti per otturazione  
Instrumentos para obturación  
Instruments pour obturation

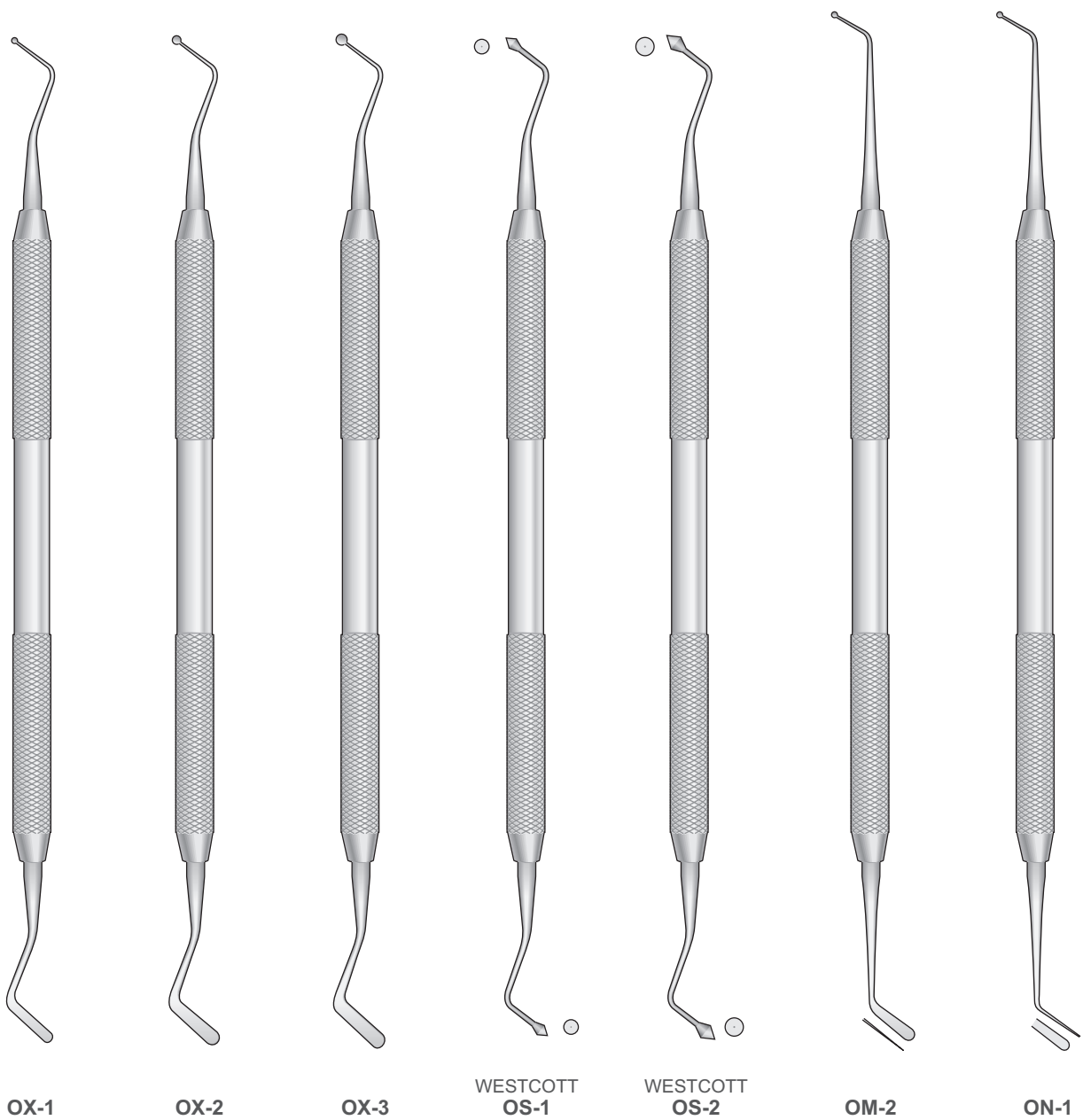

## Dental Restoration

Restaurative Zahnheilkunde  
Odontoiatria conservativa  
Odontología conservadora  
Odontologie conservatrice

## Periodontics / Endodontics / Restoration

Parodontologie / Endodontie / Restauration  
Parodontie / Endodontie / Restauration  
Parodontologia / Endodonzia / Restauro  
Parodontologiya / Endodontiya / Restavratsiya

Füllungsinstrumente  
Filling Instruments  
Strumenti per otturazione  
Instrumentos para obturación  
Instruments pour obturation

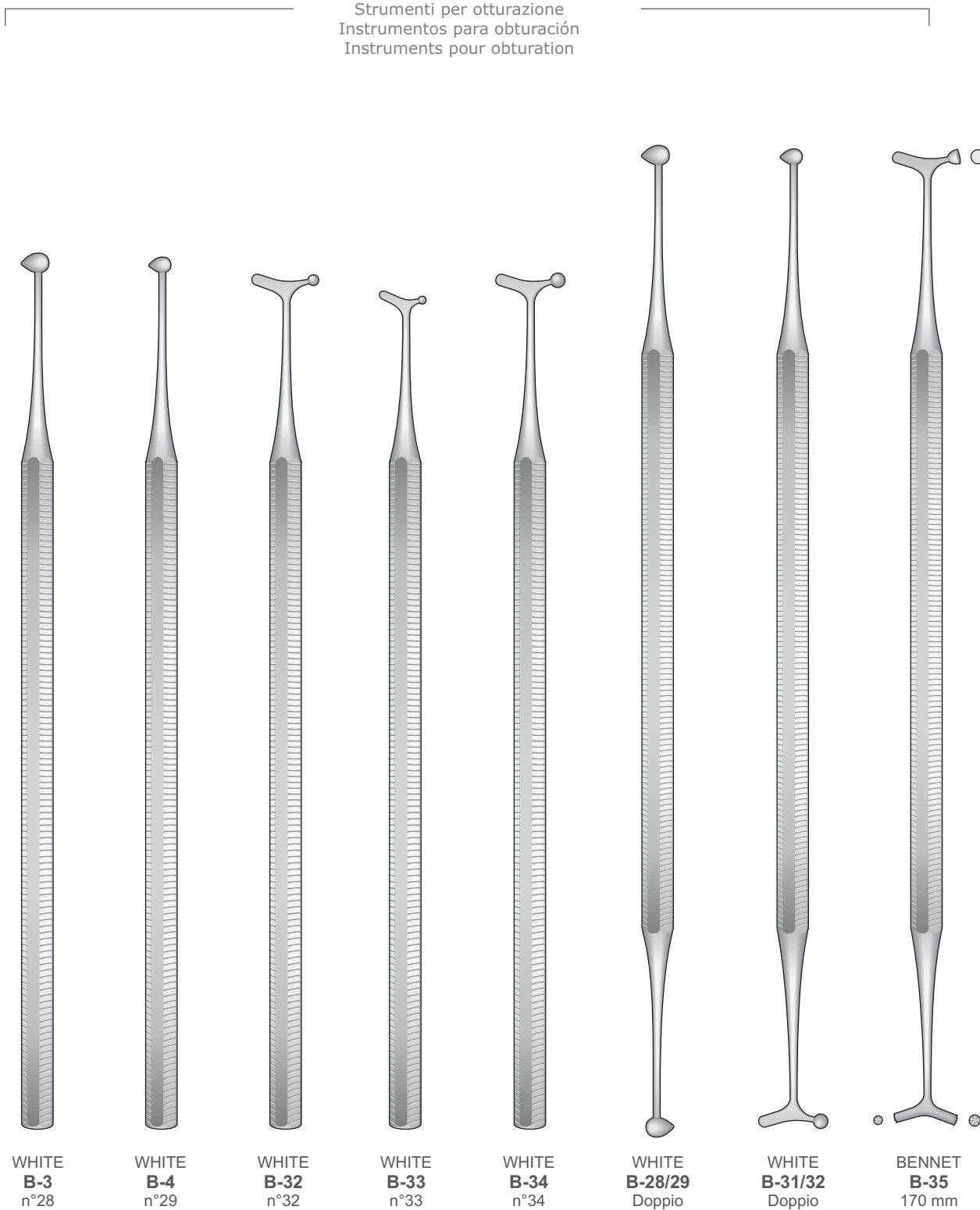

## Filling Instruments

Füllungsinstrumente  
Strumenti per otturazione  
Instrumentos para obturación  
Instruments pour obturation

### MARKLEY PLUGGERS Amalgam Instrumente Amalgam Instruments Strumenti per amalgama Instrumentos para amalgama Instruments à amalgame

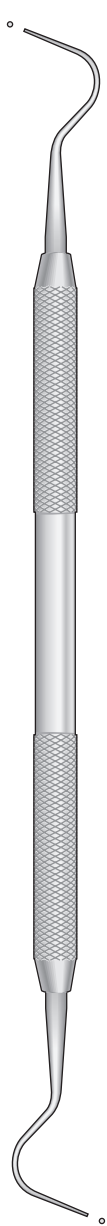

**PM-1**  
Fig.1M

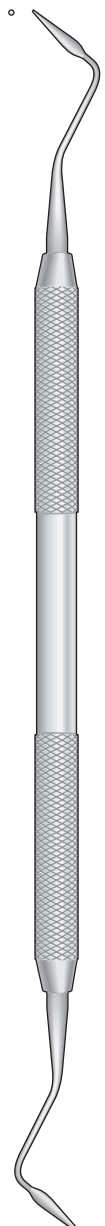

**PM-2**  
Fig.2M

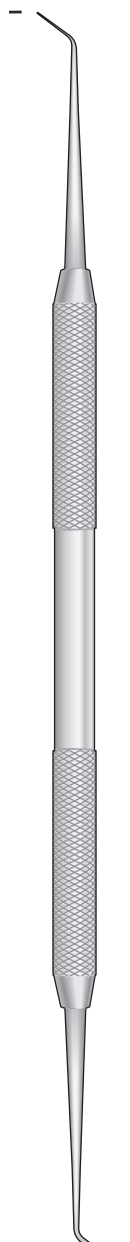

**PM-3**  
Fig.3M

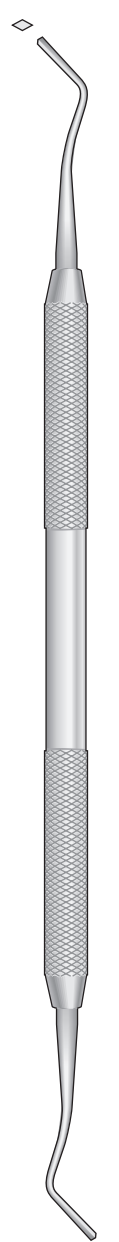

**PM-4**  
Fig.4M



**PM-5**  
Fig.5M



**PM-6**  
Fig.6M

## Enamel Instruments

Schmelzinstrumente  
Strumenti da smalto  
Instrumentos para esmalte  
Instruments à émail

## Periodontics / Endodontics / Restoration

Parodontologie / Endodontie / Restauration  
Parodontie / Endodontie / Restauration  
Parodontologia / Endonzia / Restauro  
Parodontologiya / Endodontiya / Restavratsiya

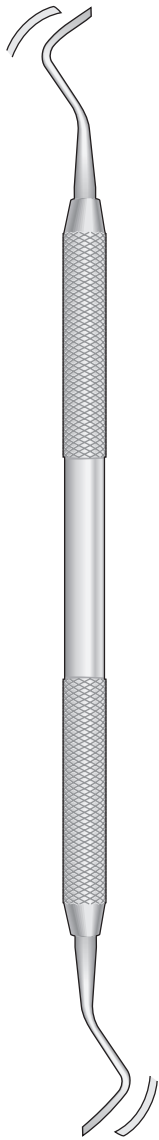

BLACK  
TS-1  
Fig.26

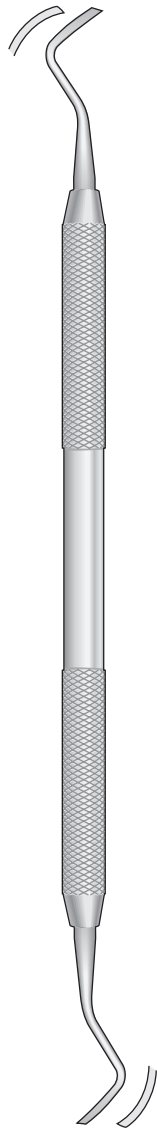

BLACK  
TS-2  
Fig.27

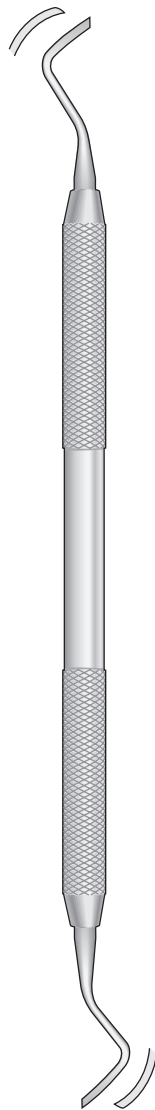

BLACK  
TS-3  
Fig.28

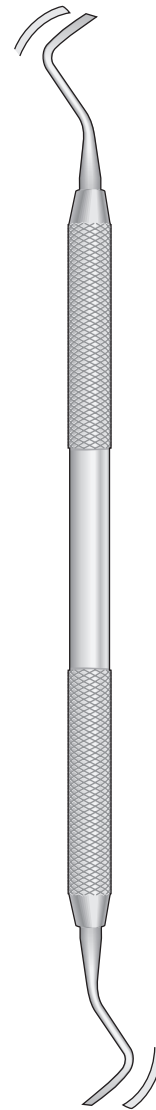

BLACK  
TS-4  
Fig.29

## Excavators

Excavatoren  
Escavatori  
Excavadores  
Excavateurs



**E-0**  
Fig.0



**E-1**  
Fig.1



**E-2**  
Fig.2



**E-3**  
Fig.3



**E-4**  
Fig.4



**EC-1**  
Fig.1



**EC-2**  
Fig.2

## Periodontal Chisels

Meißel für Parodontologie  
Scalpelli parodontali  
Cinceles periodontales  
Burins parodontaux

## Periodontics / Endodontics / Restoration

Parodontologie / Endodontie / Restauration  
Parodontie / Endodontie / Restauration  
Parodontologia / Endodonzia / Restauro  
Parodontologiya / Endodontiya / Restavratsiya

Fig. 1

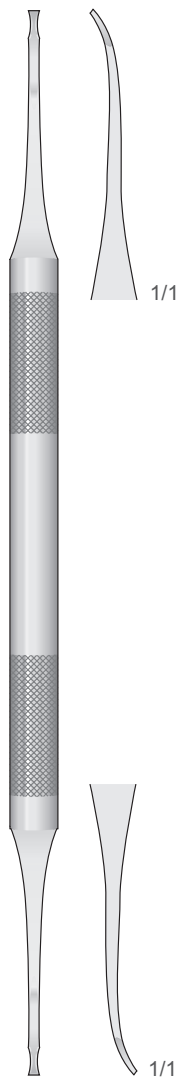

FEDI  
OF-1  
175 mm

Fig. 2

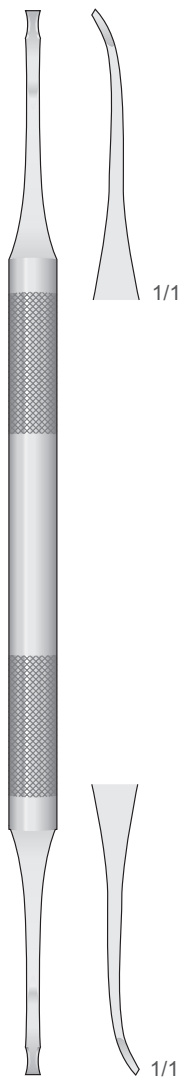

FEDI  
OF-2  
175 mm

Fig. 3



FEDI  
OF-3  
170 mm

Fig. 4

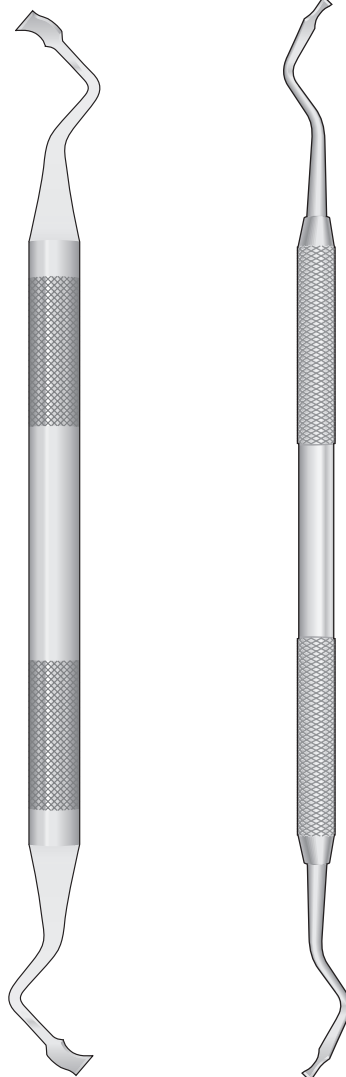

OCHSENBEIN  
OSB-4A  
170 mm

OCHSENBEIN  
OSB-4  
170 mm

## Periodontal Chisels

Meißel für Parodontologie  
Scalpelli parodontali  
Cinceles periodontales  
Burins parodontaux

Bevel IN  
Fig.1



OCHSENBEIN-1  
OSB-1  
165 mm

Bevel OUT  
Fig.2



OCHSENBEIN-2  
OSB-2  
165 mm



TG CHISELS  
718-113

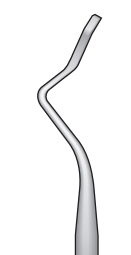

OCHSENBEIN-3  
718-103

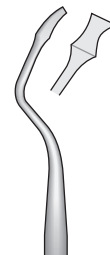

OCHSENBEIN-4  
718-104



RHODES BACK ACTION  
718-107



## Gingivectomy Knives

Parodontalmesser

Bisturi per gengivectomia

Bisturíes para la gengivectomía

Bistouris pour la gengivectomie

## Periodontics / Endodontics / Restoration

Parodontologie / Endodontie / Restauration

Parodontie / Endodontie / Restauration

Parodontologia / Endodonzia / Restauro

Parodontologiya / Endodontiya / Restavratsiya

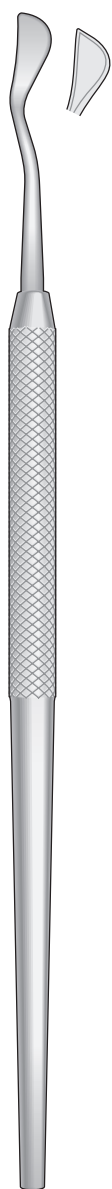

KIRKLAND  
**KKD-1**  
Fig.15K

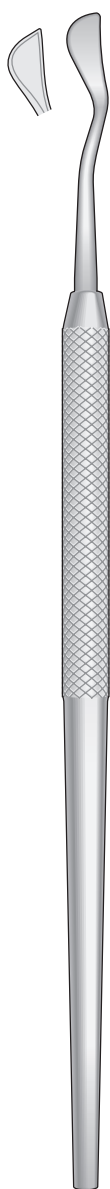

KIRKLAND  
**KKD-2**  
Fig.16K

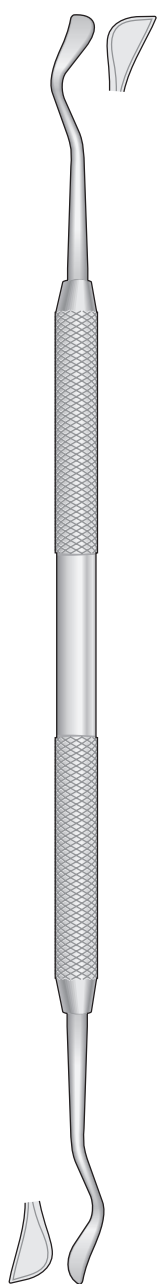

KIRKLAND  
**KKD-4**  
Fig.15K - Fig.16K

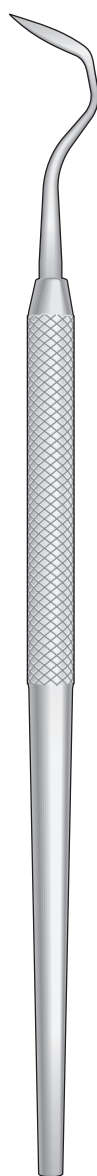

ORBAN  
**OBN-1**  
Fig.1

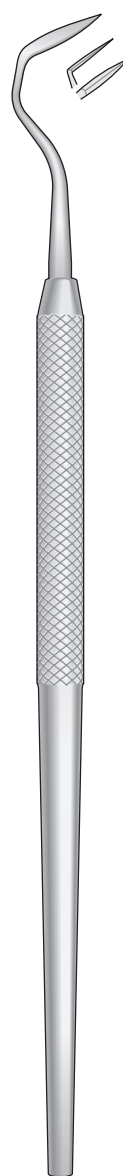

ORBAN  
**OBN-2**  
Fig.2

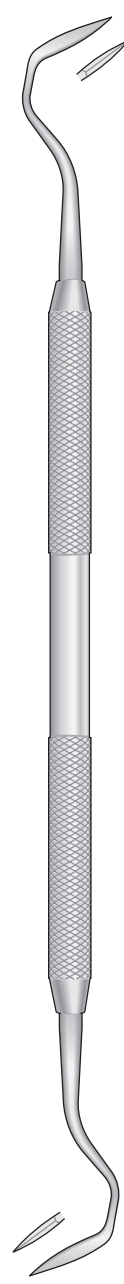

ORBAN  
**OBN-4**  
Fig.1 - Fig.2



## Double-ended Explorer

Doppelendiger Zahnsonden

Sonda falce doppia

Sonda exploradora doble

Sonde exploratrice double

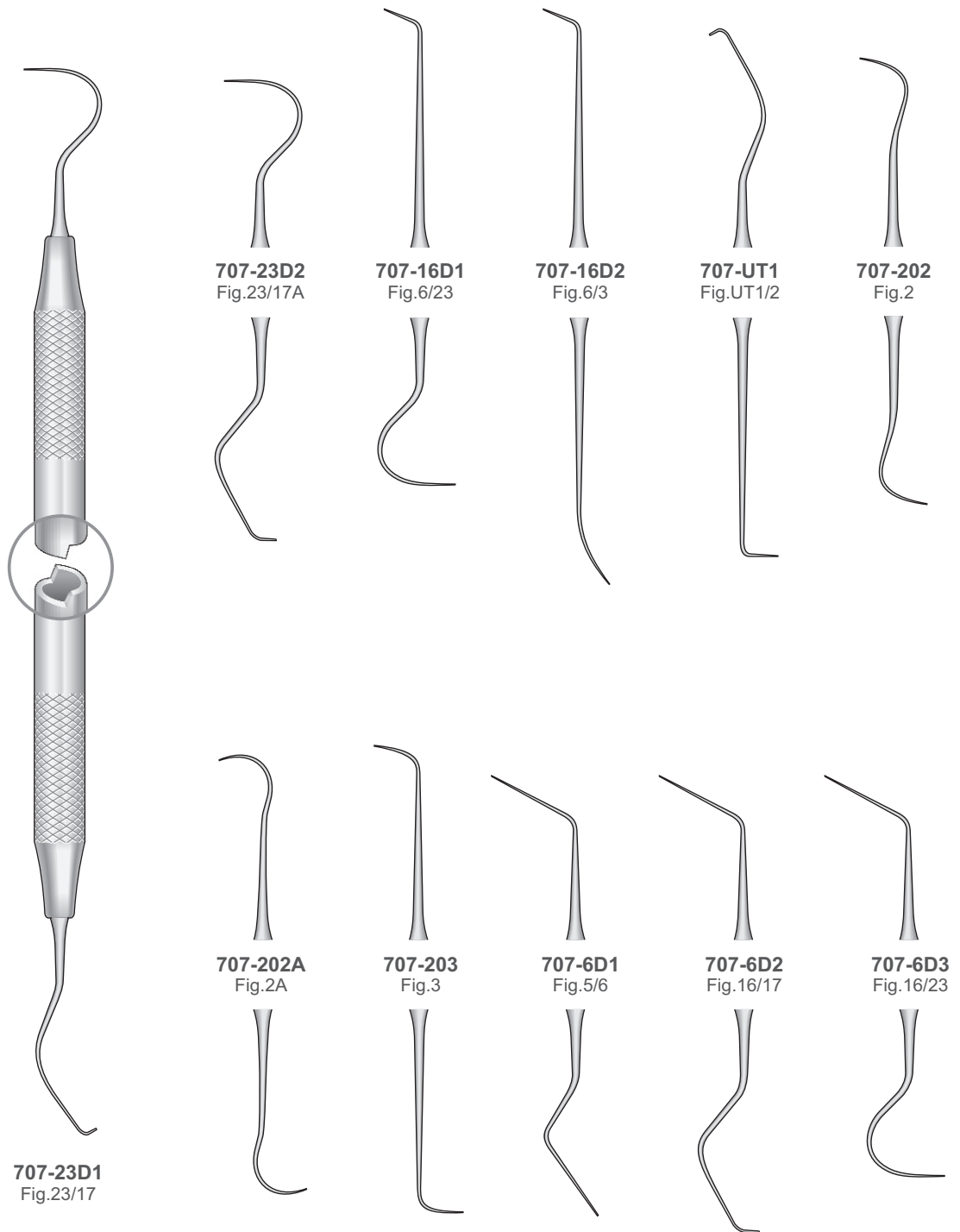

## Double-ended Periodontal Probes

Doppelendiger Parodontometer  
 Sondes parodontales doubles  
 Sonde parodontali doppie  
 Sondas parodontales doubles

## Periodontics / Endodontics / Restoration

Parodontologie / Endodontie / Restauration  
 Parodontie / Endodontie / Restauration  
 Parodontologia / Endodontia / Restauro  
 Parodontologiya / Endodontiya / Restavratsiya

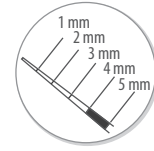
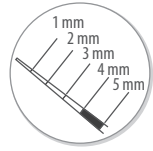

### GOLDMANN-FOX

### GOLDMANN-FOX WILLIAMS

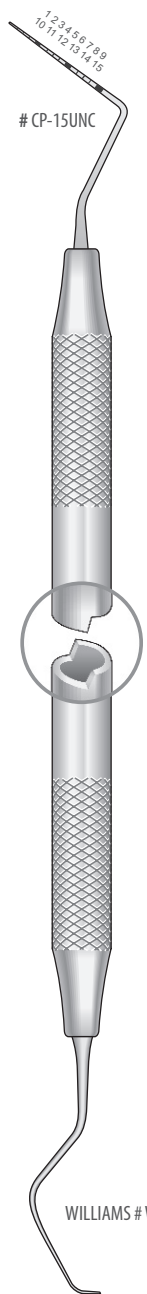

**707-1715**  
 # CP-15UNC-17A  
 170 mm

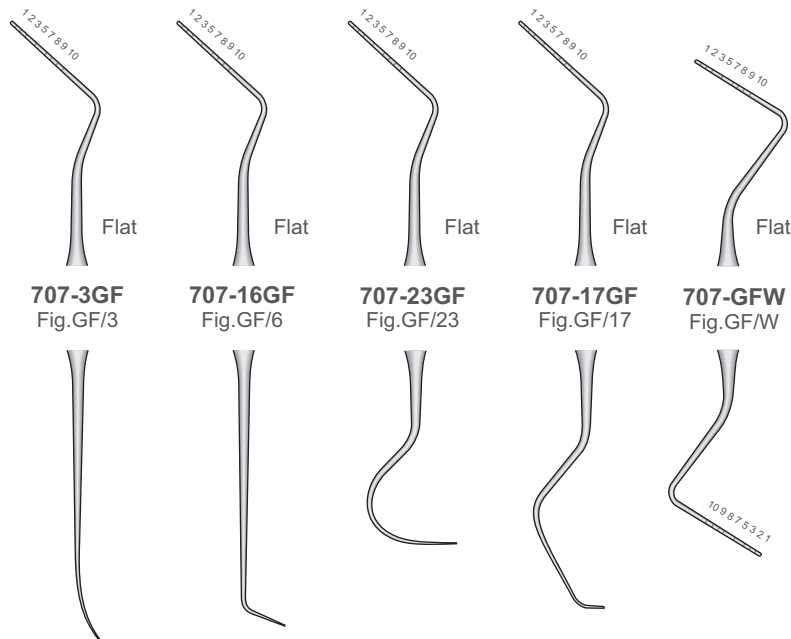

**707-3GF**  
 Fig.GF/3

**707-16GF**  
 Fig.GF/6

**707-23GF**  
 Fig.GF/23

**707-17GF**  
 Fig.GF/17

**707-GFW**  
 Fig.GFW

### WILLIAMS

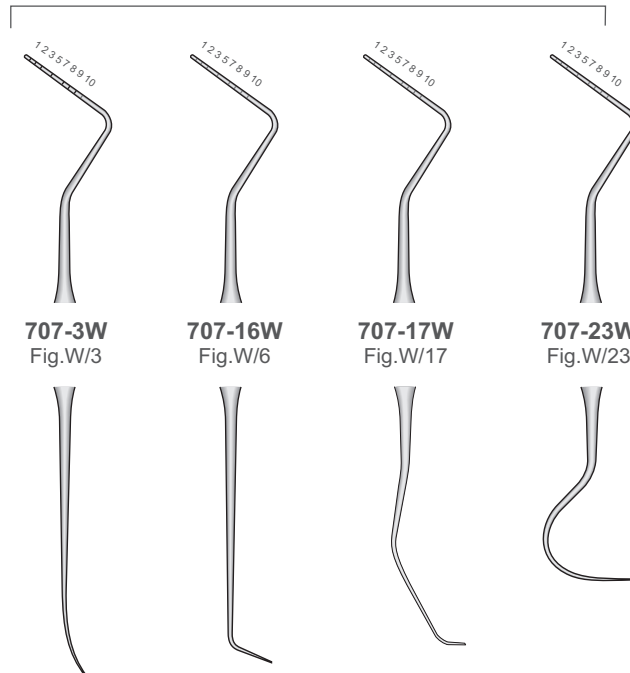

**707-3W**  
 Fig.W/3

**707-16W**  
 Fig.W/6

**707-17W**  
 Fig.W/17

**707-23W**  
 Fig.W/23

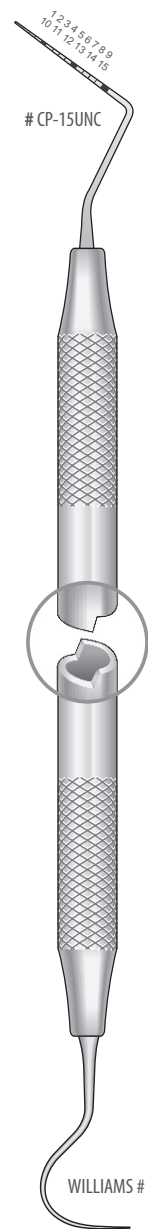

**707-2315**  
 # CP-15UNC-23/W  
 170 mm

**Double-ended Periodontal Probes**

Doppelendiger Parodontometer  
 Sondes parodontales doubles  
 Sonde parodontali doppie  
 Sondas parodontales doubles

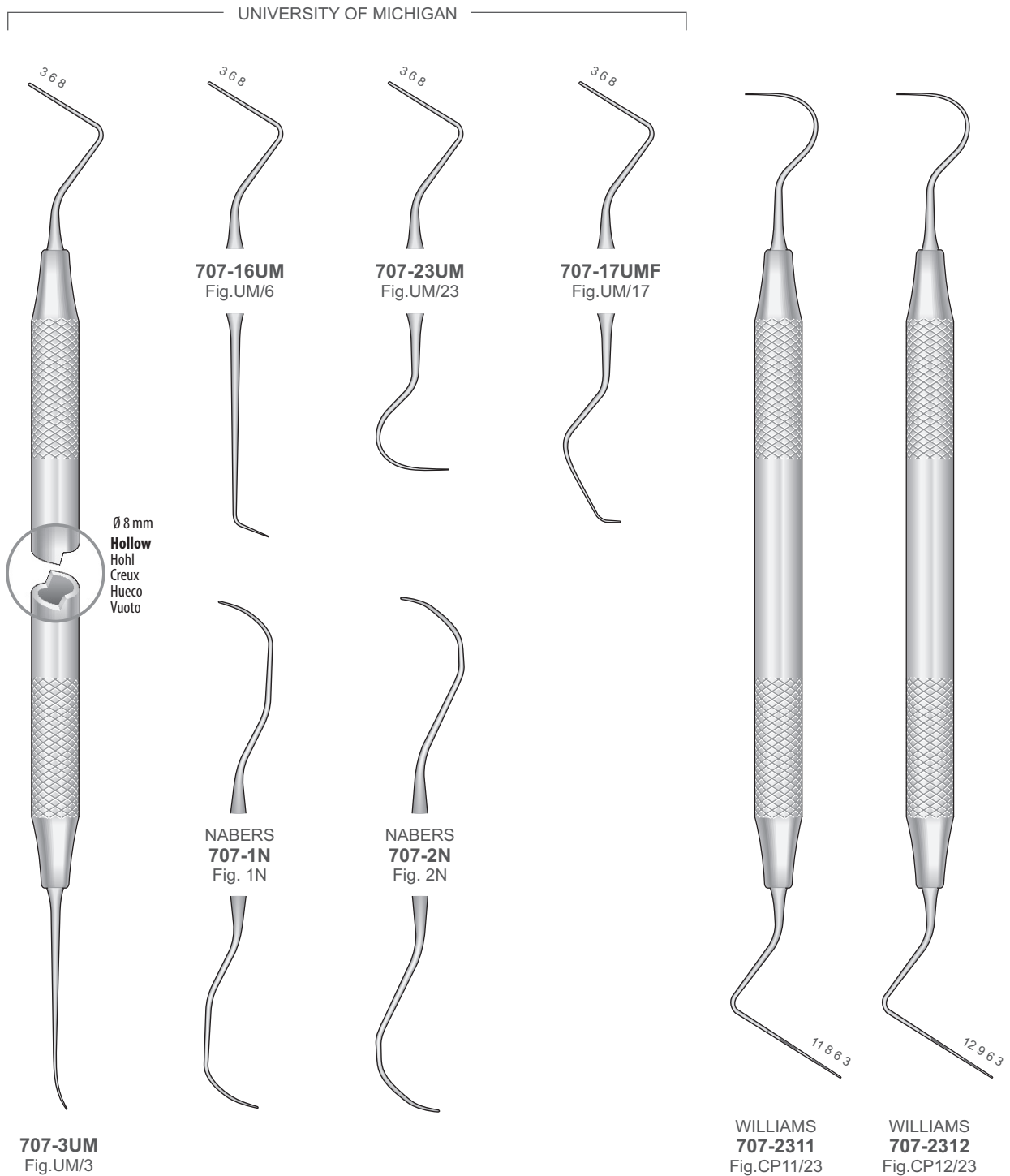

## Spatulas - Filling Instruments

Spateln - Füllungsinstrumente

Spatole - Strumenti per otturazione

Espátulas - Instrumentos para obturación

Spatules - Instruments pour obturation

## Periodontics / Endodontics / Restoration

Parodontologie / Endodontie / Restauration

Parodontie / Endodontie / Restauration

Parodontologia / Endodonzia / Restauro

Parodontologiya / Endodontiya / Restavratsiya

Heidemann Spateln  
Heidemann Spatulas  
Spatole Heidemann  
Espátulas Heidemann  
Spatules Heidemann

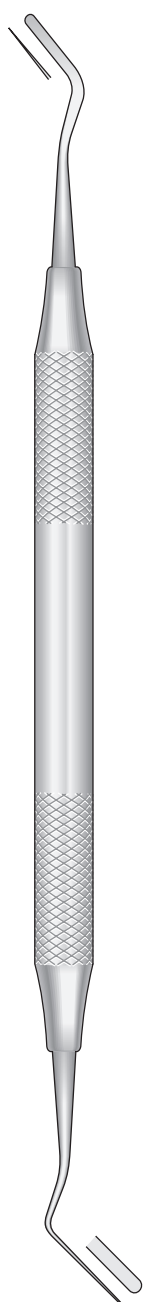

HEIDEMANN  
711-301  
Fig.1

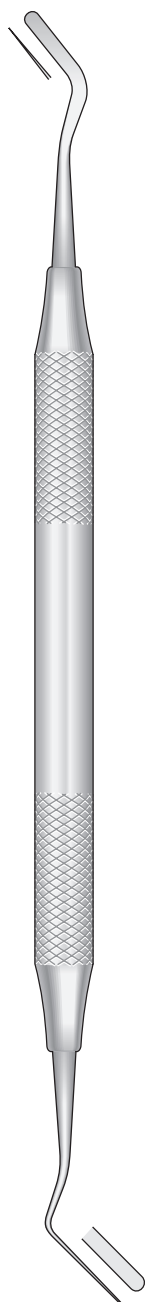

HEIDEMANN  
711-302  
Fig.2

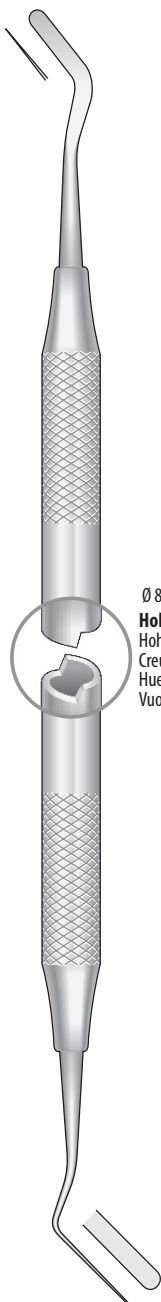

HEIDEMANN  
711-303  
Fig.3

Ø 8 mm  
**Hollow**  
Hohl  
Creux  
Hueco  
Vuoto



IPC Fig. 1  
715-311  
Interproximal

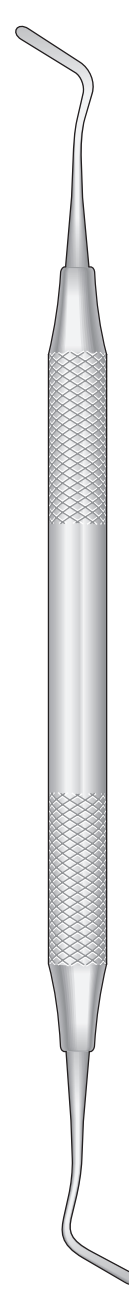

IPC/OA Fig. 2  
715-312  
Interproximal Off-Angle

**Filling Instruments**

Füllungsinstrumente  
Strumenti per otturazione  
Instrumentos para obturación  
Instruments pour obturation

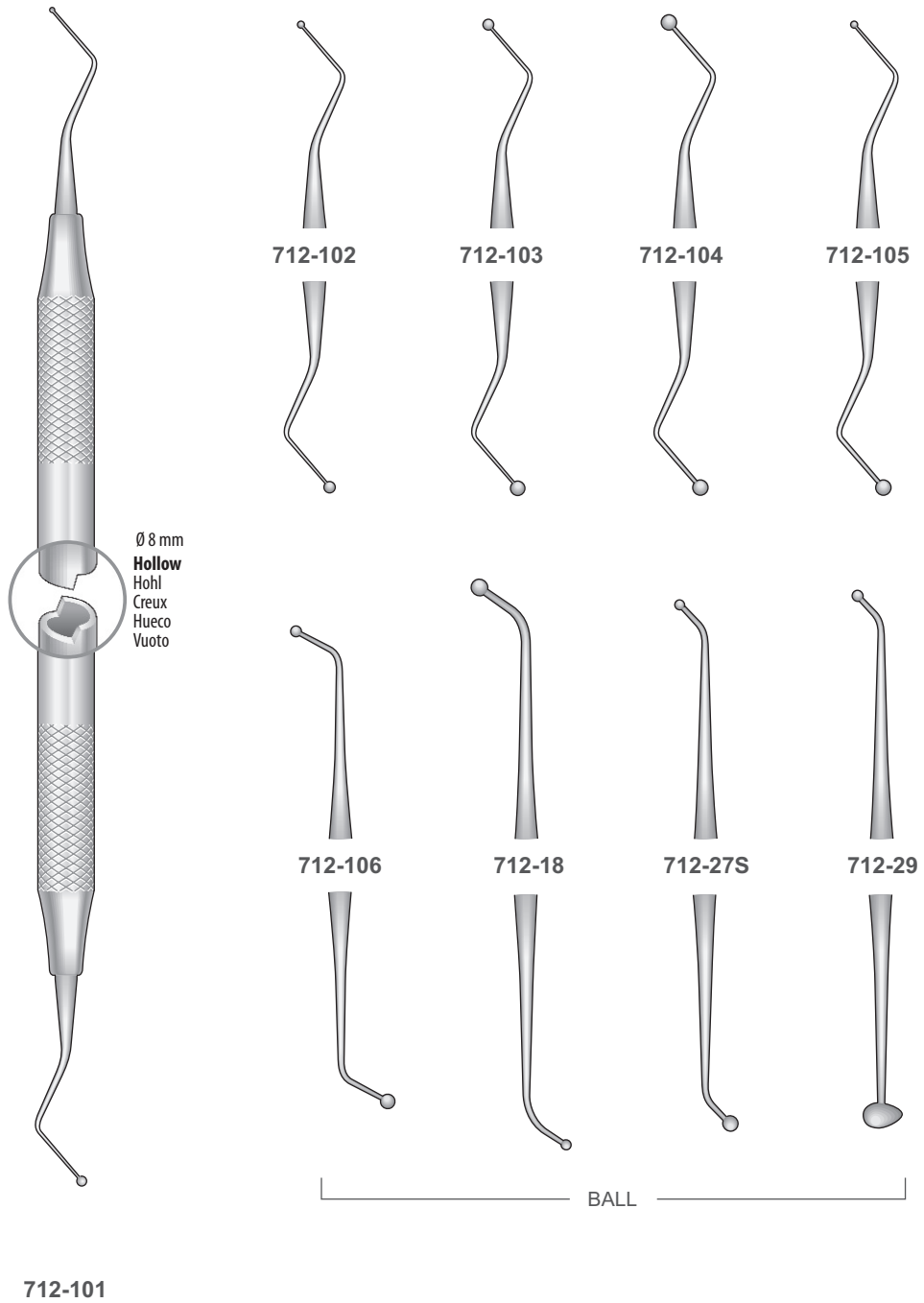

## Filling Instruments

Füllungsinstrumente  
Strumenti per otturazione  
Instrumentos para obturación  
Instruments pour obturation

## Periodontics / Endodontics / Restoration

Parodontologie / Endodontie / Restauration  
Parodontie / Endodontie / Restauration  
Parodontologia / Endodonzia / Restauro  
Parodontologiya / Endodontiya / Restavratsiya

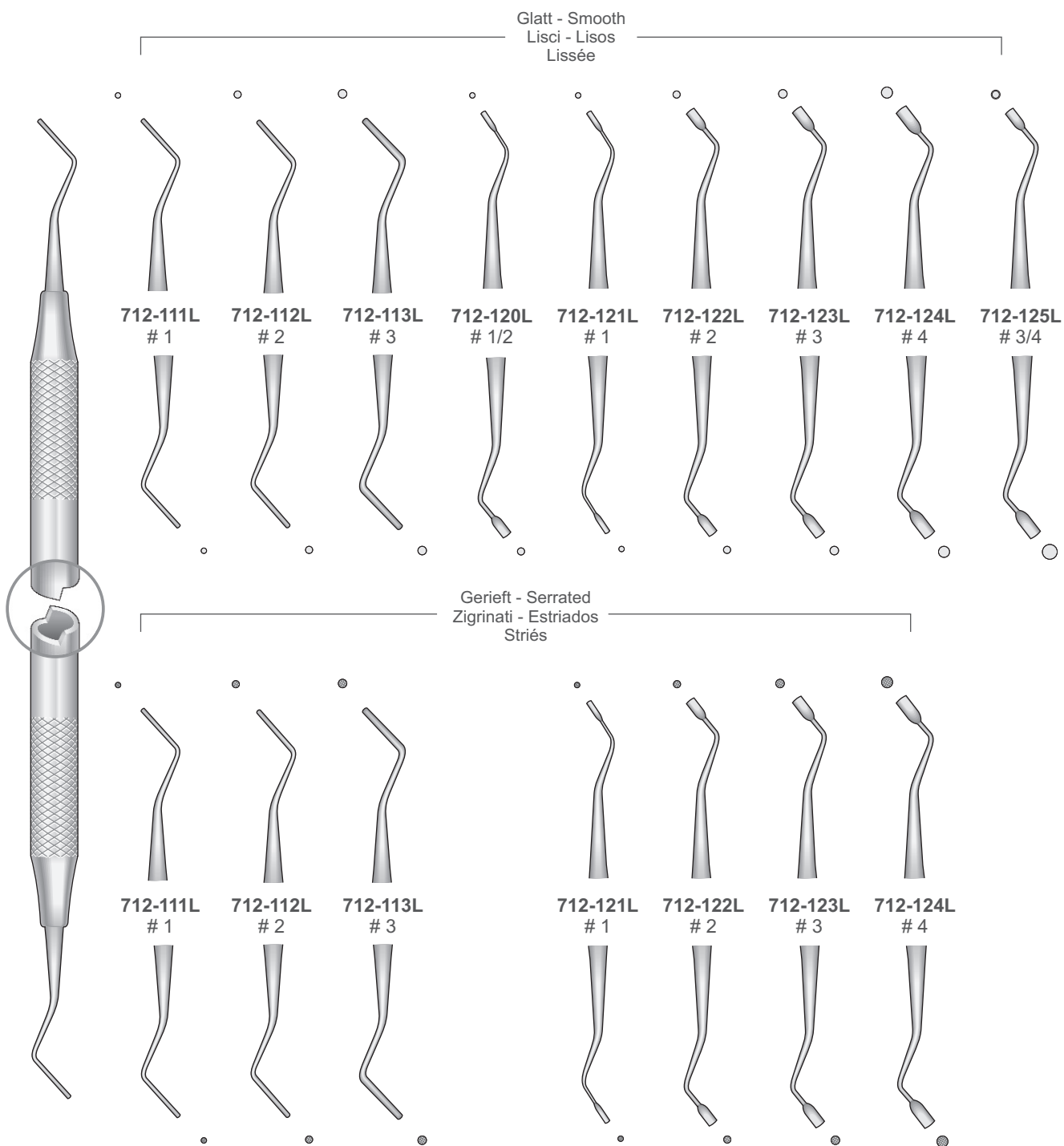

## Filling Instruments

Füllungsinstrumente  
Strumenti per otturazione  
Instrumentos para obturación  
Instruments pour obturation

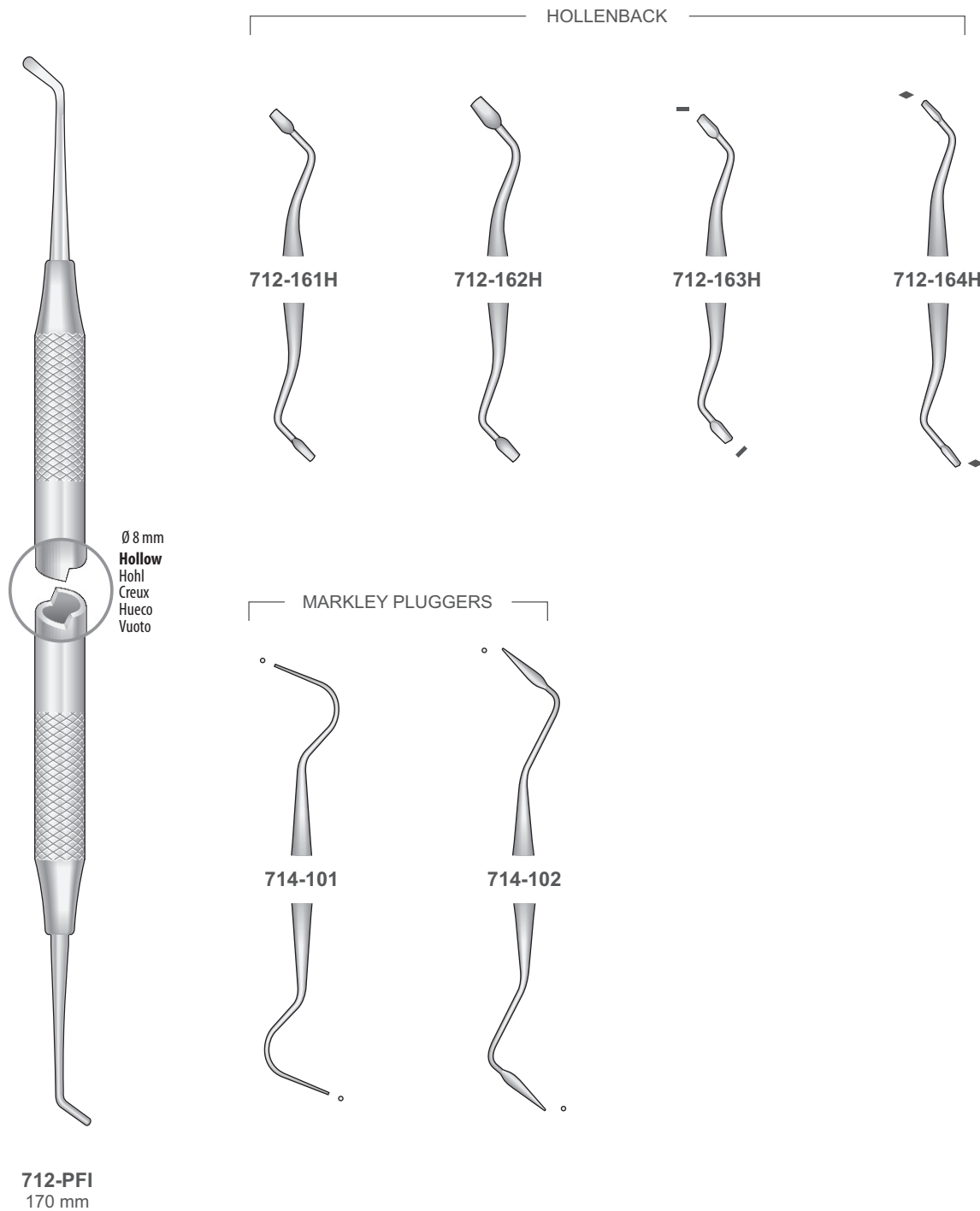

## Filling Instruments

Füllungsinstrumente  
Strumenti per otturazione  
Instrumentos para obturación  
Instruments pour obturation

## Periodontics / Endodontics / Restoration

Parodontologie / Endodontie / Restauration  
Parodontie / Endodontie / Restauration  
Parodontologia / Endodonzia / Restauro  
Parodontologiya / Endodontiya / Restavratsiya

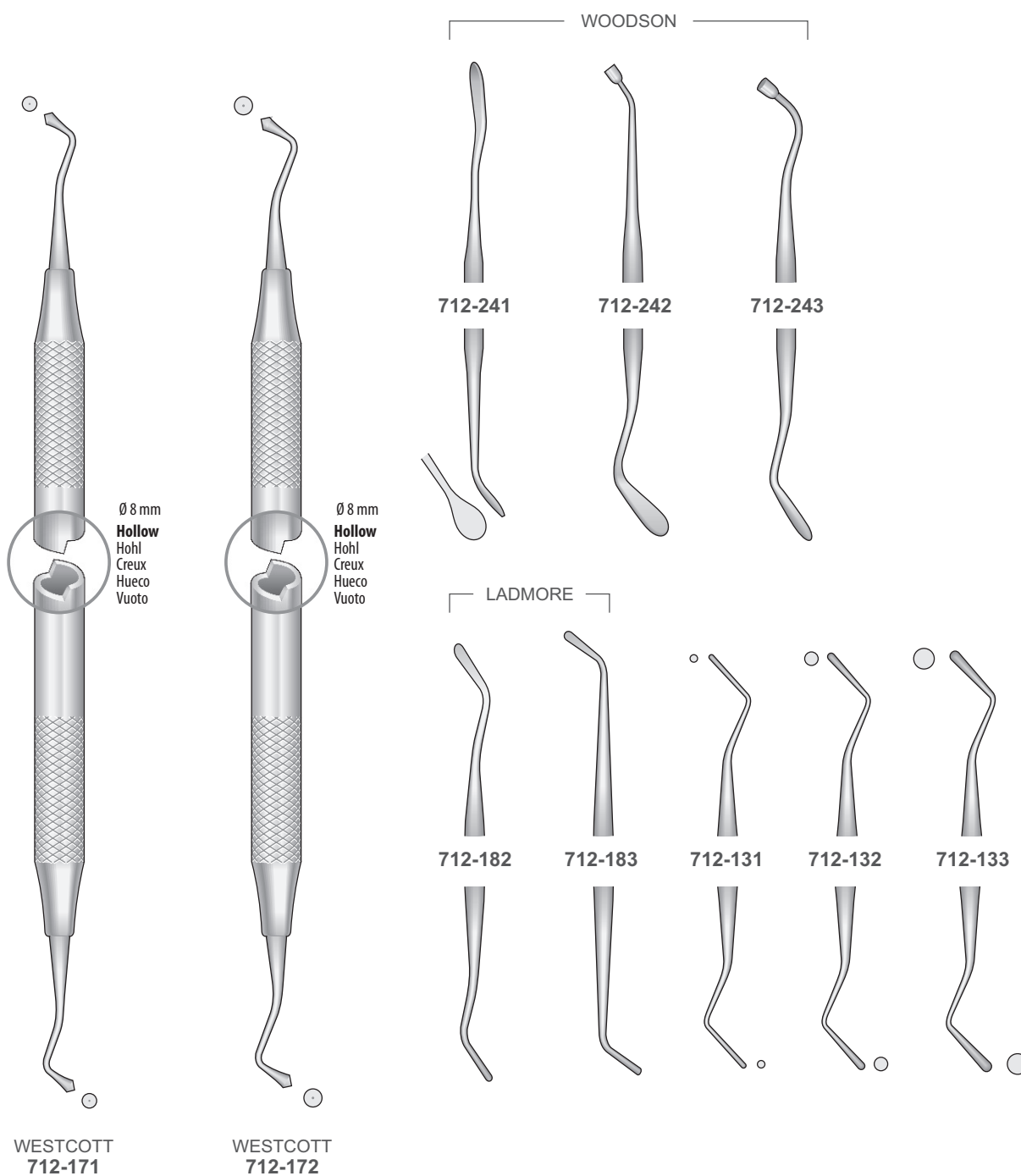



## Filling Instruments

Füllungsinstrumente  
Strumenti per otturazione  
Instrumentos para obturación  
Instruments pour obturation

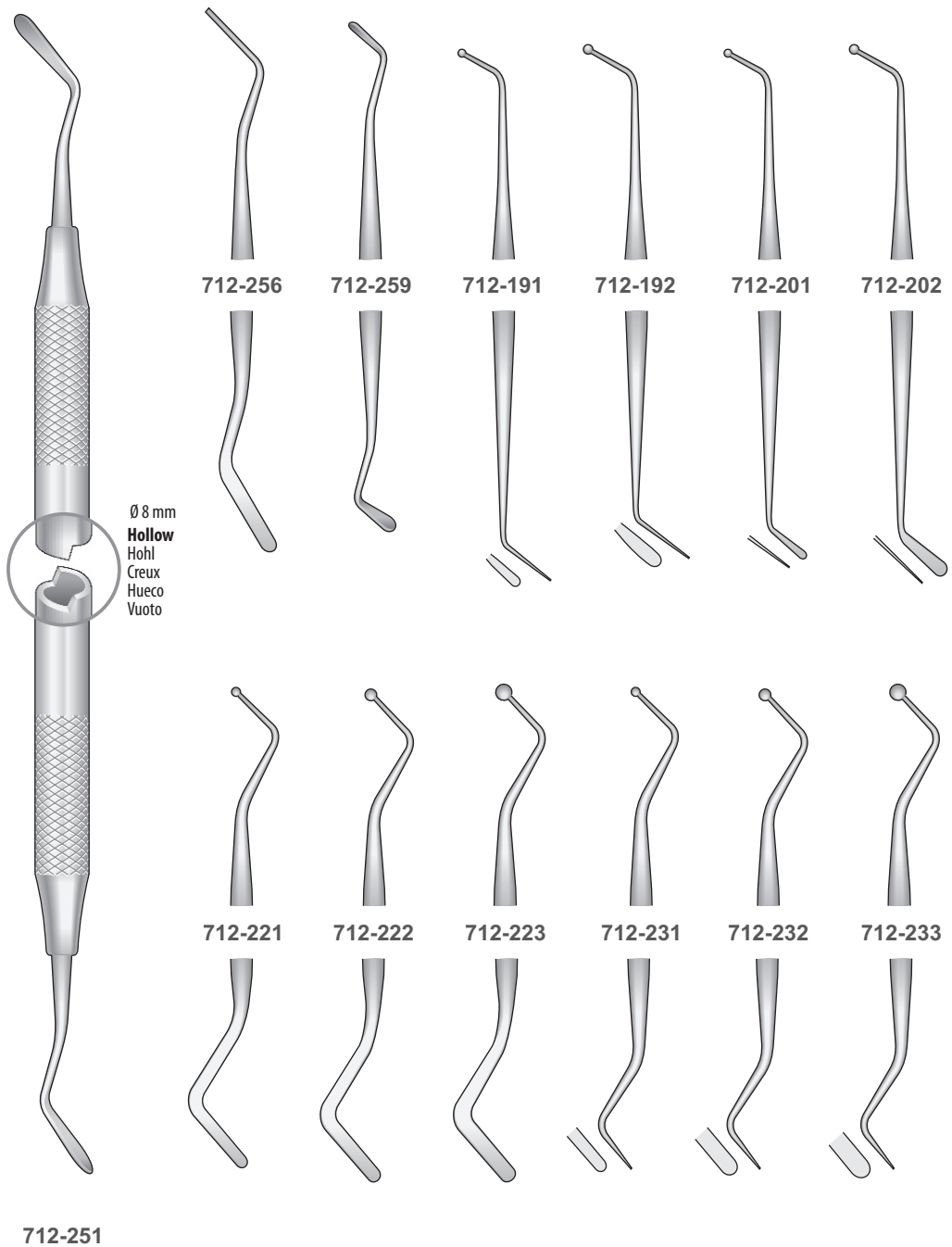

## Amalgam carvers

Amalgam Instrumente

Strumenti per modellare otturazioni

Instrumentos para modelar las obturaciones

Instruments à modeler les obturations

## Periodontics / Endodontics / Restoration

Parodontologie / Endodontie / Restauration

Parodontie / Endodontie / Restauration

Parodontologia / Endodonzia / Restauro

Parodontologiya / Endodontiya / Restavratsiya

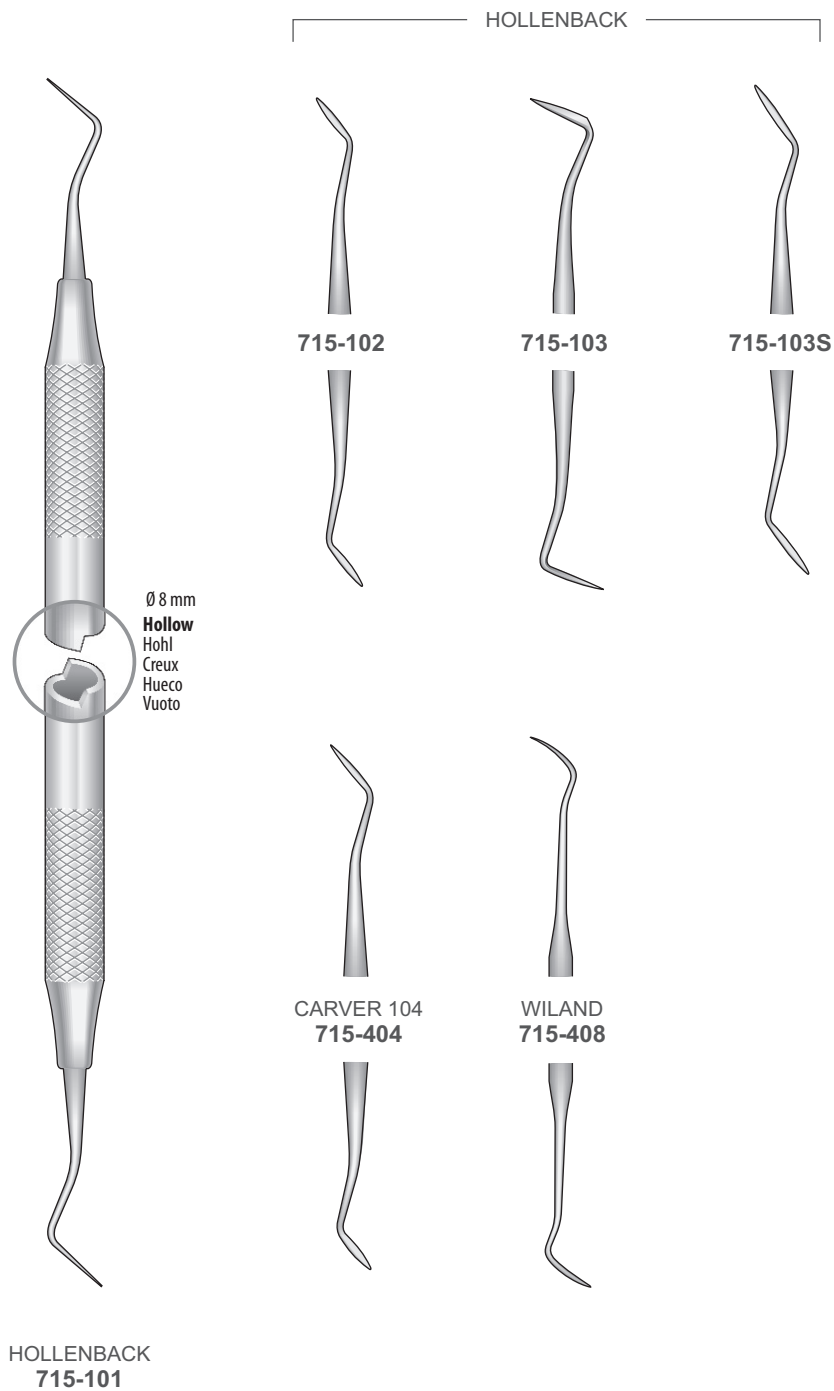

## Cavity preparation instruments

Schmelzinstrumente  
Strumenti da smalto  
Instrumentos para esmalte  
Instruments à émail

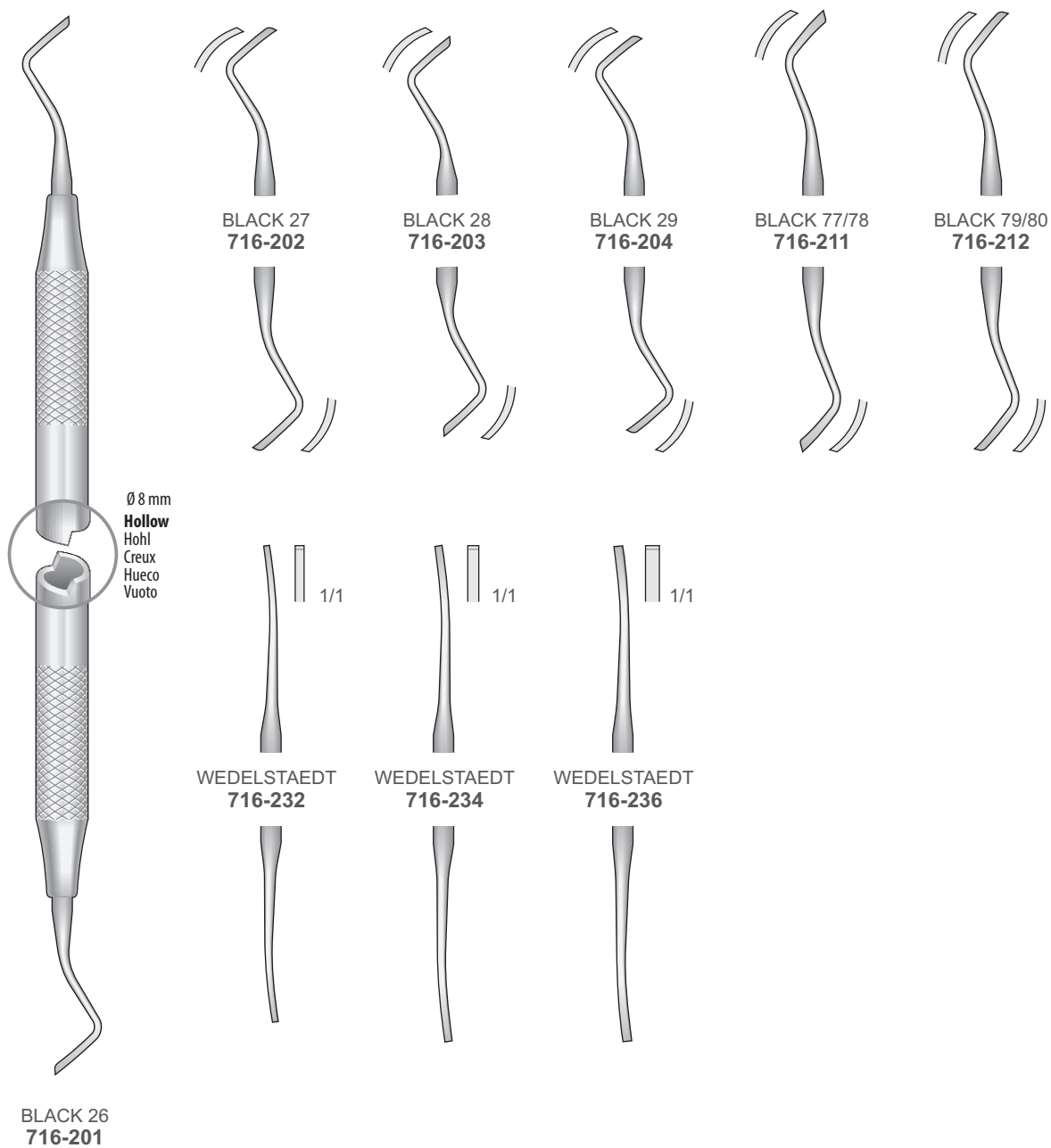

## Amalgam carvers

Amalgam Instrumente  
Strumenti per modellare otturazioni  
Instrumentos para modelar las obturaciones  
Instruments à modeler les obturations

## Periodontics / Endodontics / Restoration

Parodontologie / Endodontie / Restauration  
Parodontie / Endodontie / Restauration  
Parodontologia / Endodonzia / Restauro  
Parodontologiya / Endodontiya / Restavratsiya

Instrument für Drahrückzug  
Instrument for Retractor wire  
Strumento per filo retrattore  
Instrumento para hilo retractor  
Instruments pour fil racteureur

Cleoids - Discoids

Dykal Applikator  
Placement Instruments  
Applicatori per sottofondo  
Aplicadores de fondo de cavidades  
Applicateurs de fond de cavité

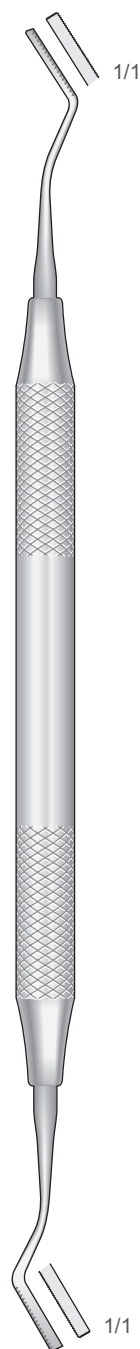

714-CV11

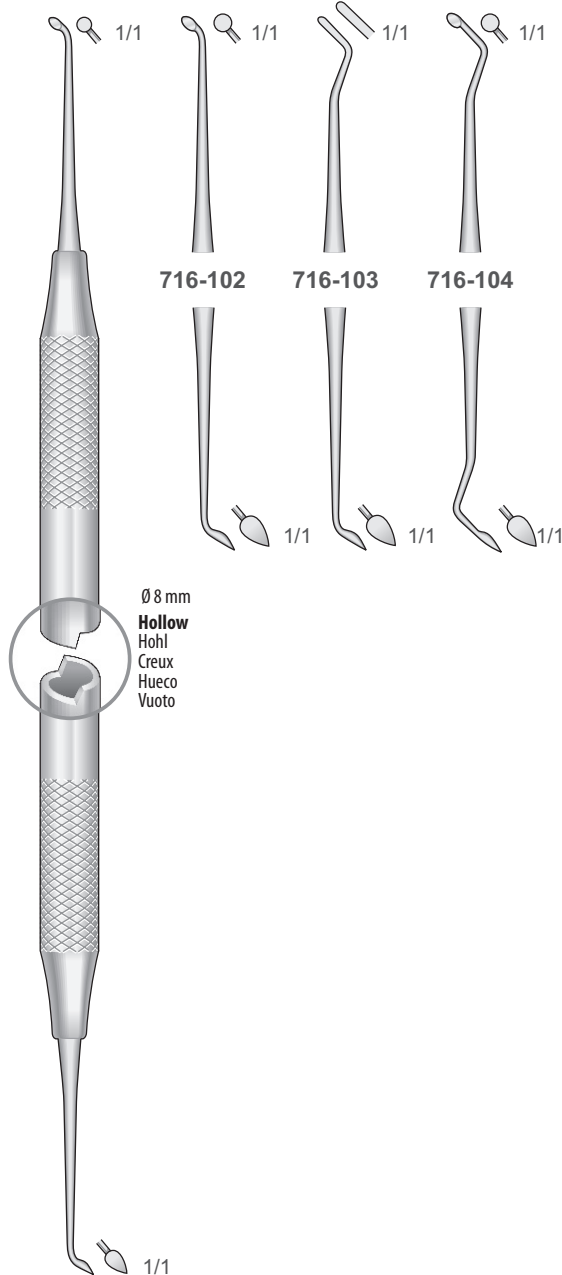

716-101

716-102

716-103

716-104

Ø 8 mm  
Hollow  
Hohl  
Creux  
Hueco  
Vuoto

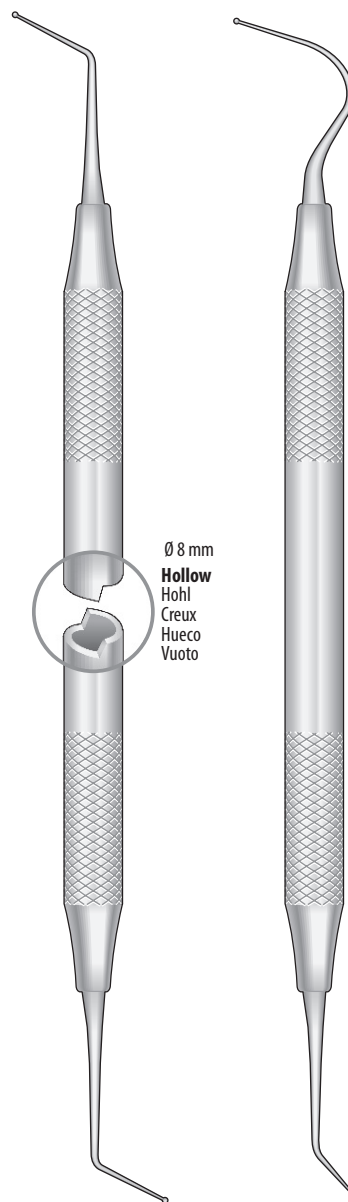

713-101

713-102

Ø 8 mm  
Hollow  
Hohl  
Creux  
Hueco  
Vuoto

## Excavators

Excavatoren  
Escavatori  
Excavadores  
Excavateurs

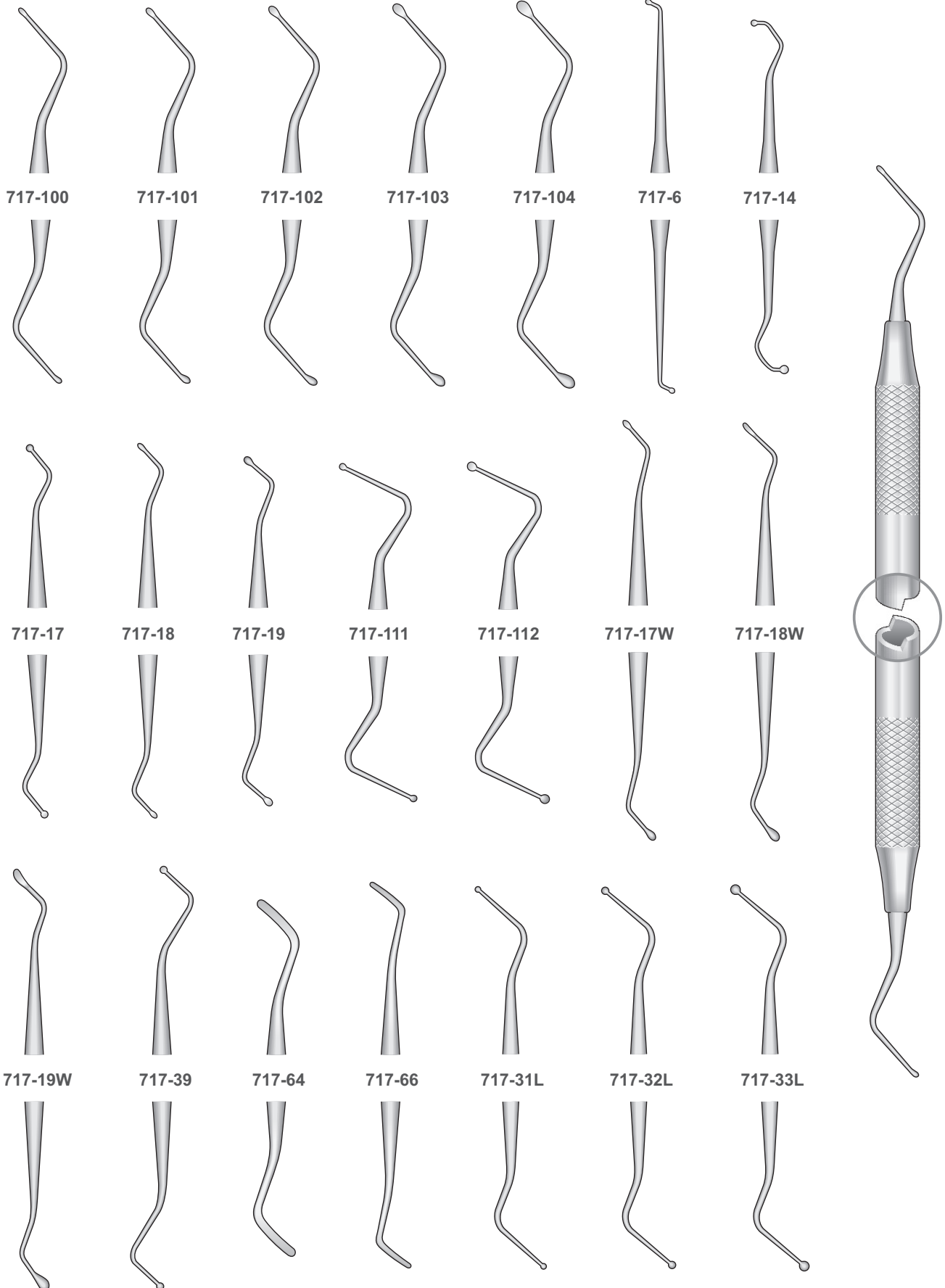

## Gingivectomy knives

Parodontalmesser  
 Bisturi per gengivectomia  
 Bisturíes para la gingivectomía  
 Bistouris pour la gingivectomie

## Periodontics / Endodontics / Restoration

Parodontologie / Endodontie / Restauration  
 Parodontie / Endodontie / Restauration  
 Parodontologia / Endodonzia / Restauro  
 Parodontologiya / Endodontiya / Restavratsiya

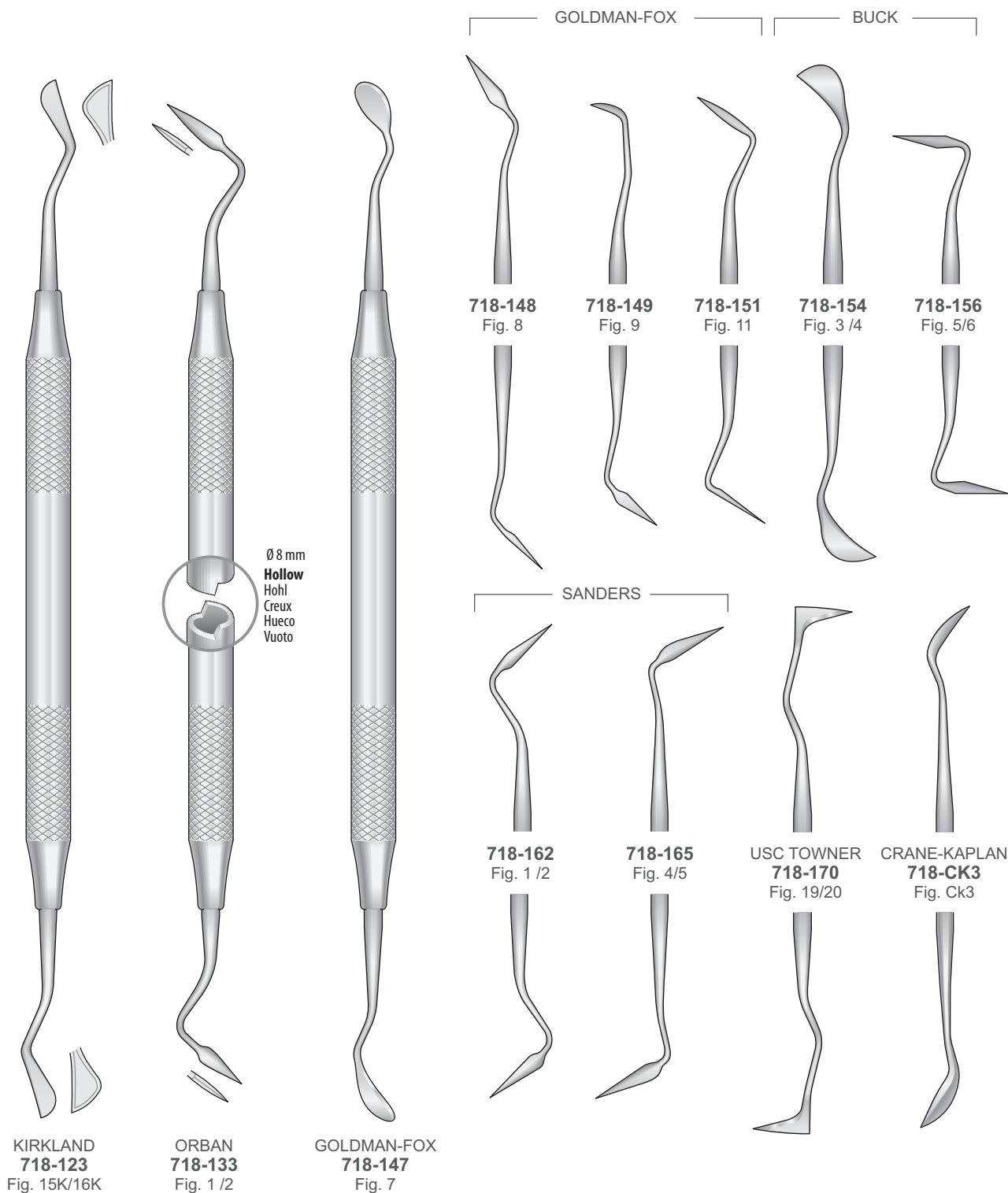

**Curettes**

Küretten  
Curette  
Curetas  
Curettes

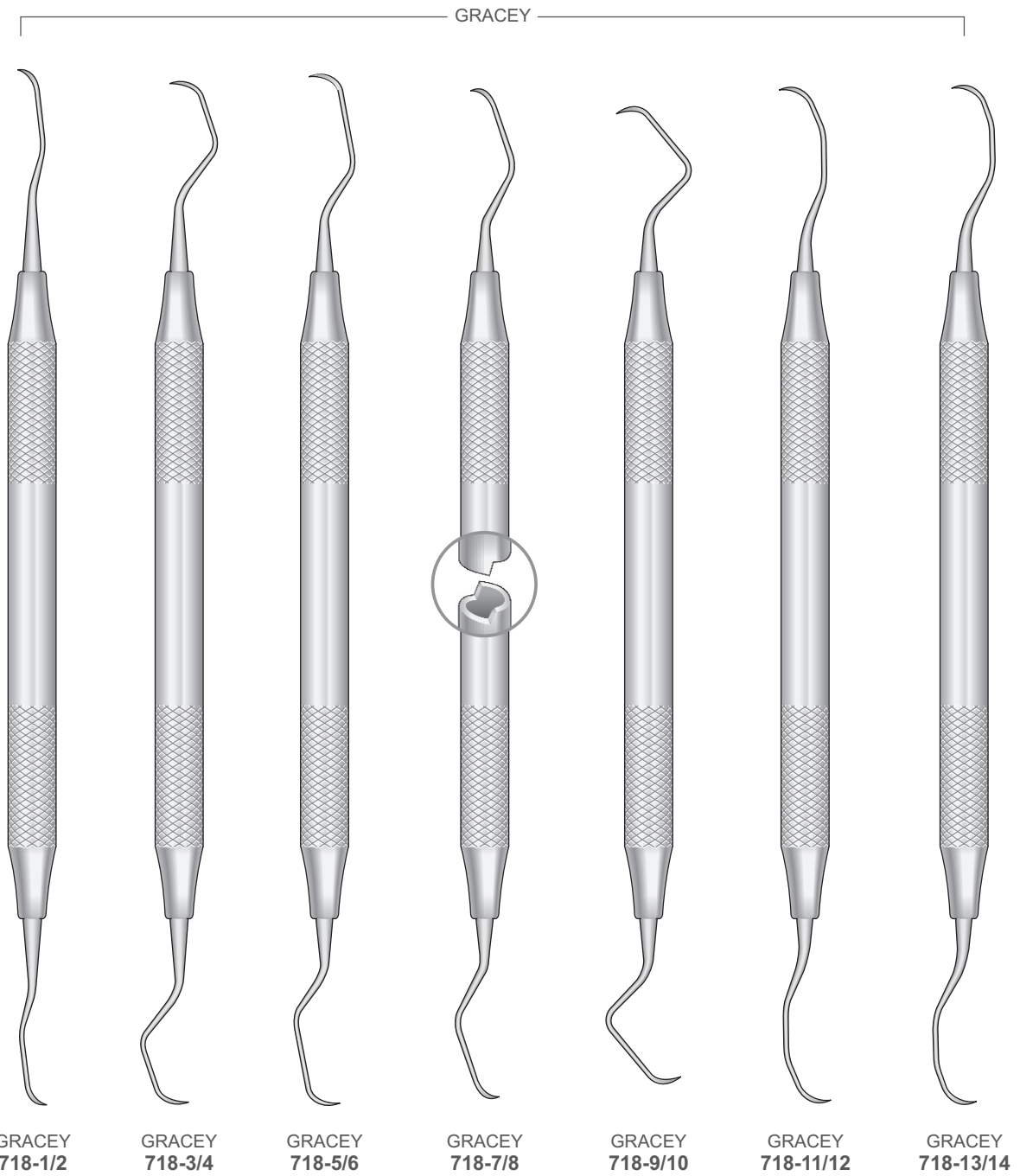

## Curettes

Küretten  
Curette  
Curetas  
Curettes

## Periodontics / Endodontics / Restoration

Parodontologie / Endodontie / Restauration  
Parodontie / Endodontie / Restauration  
Parodontologia / Endodonzia / Restauro  
Parodontologiya / Endodontiya / Restavratsiya

Mesial - Distal

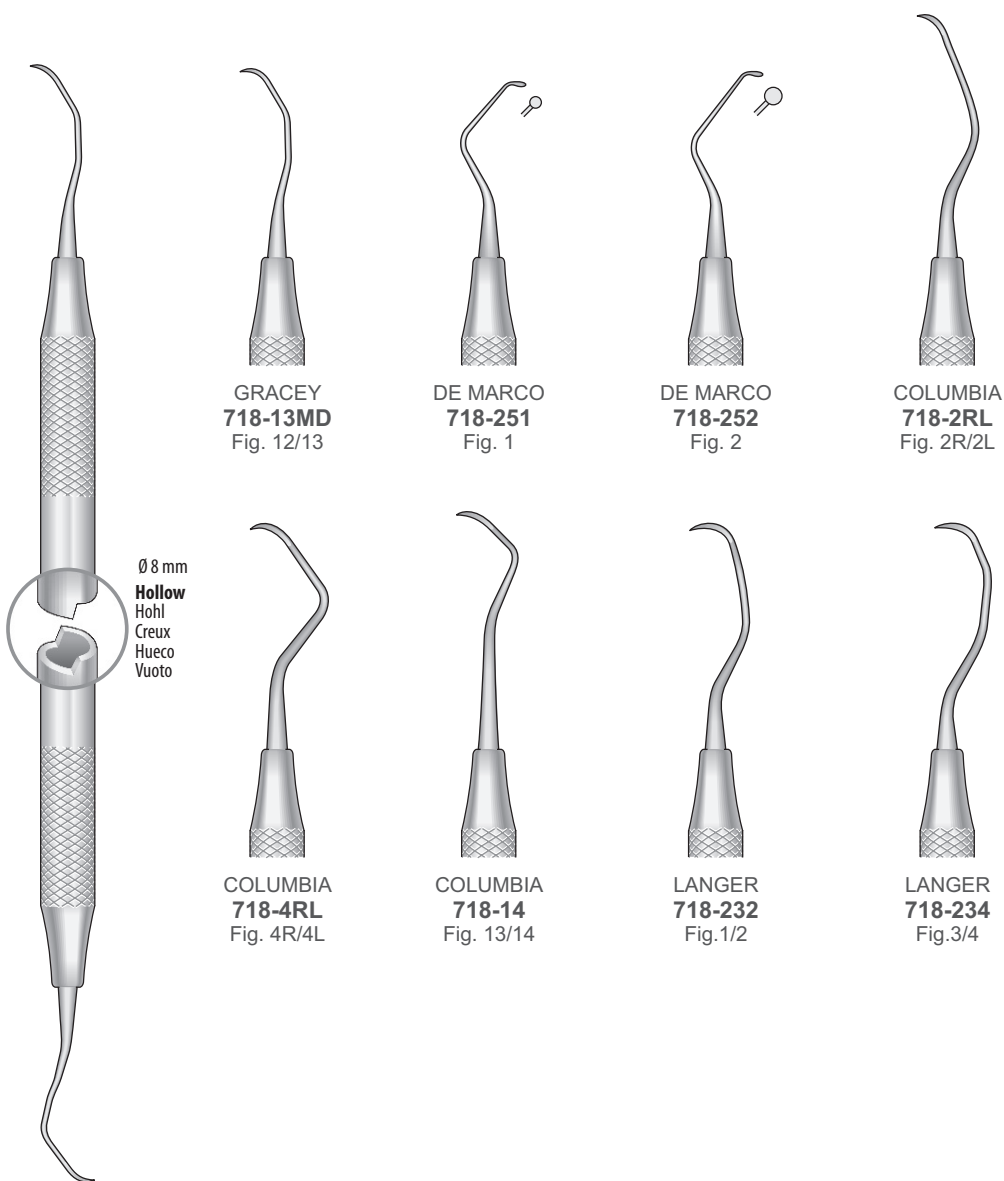

GRACEY  
718-11MD  
Fig. 11/14

GRACEY  
718-13MD  
Fig. 12/13

DE MARCO  
718-251  
Fig. 1

DE MARCO  
718-252  
Fig. 2

COLUMBIA  
718-2RL  
Fig. 2R/2L

Ø 8 mm  
Hollow  
Hohl  
Creux  
Hueco  
Vuoto

COLUMBIA  
718-4RL  
Fig. 4R/4L

COLUMBIA  
718-14  
Fig. 13/14

LANGER  
718-232  
Fig.1/2

LANGER  
718-234  
Fig.3/4



**Curettes**

Küretten  
Curette  
Curetas  
Curettes

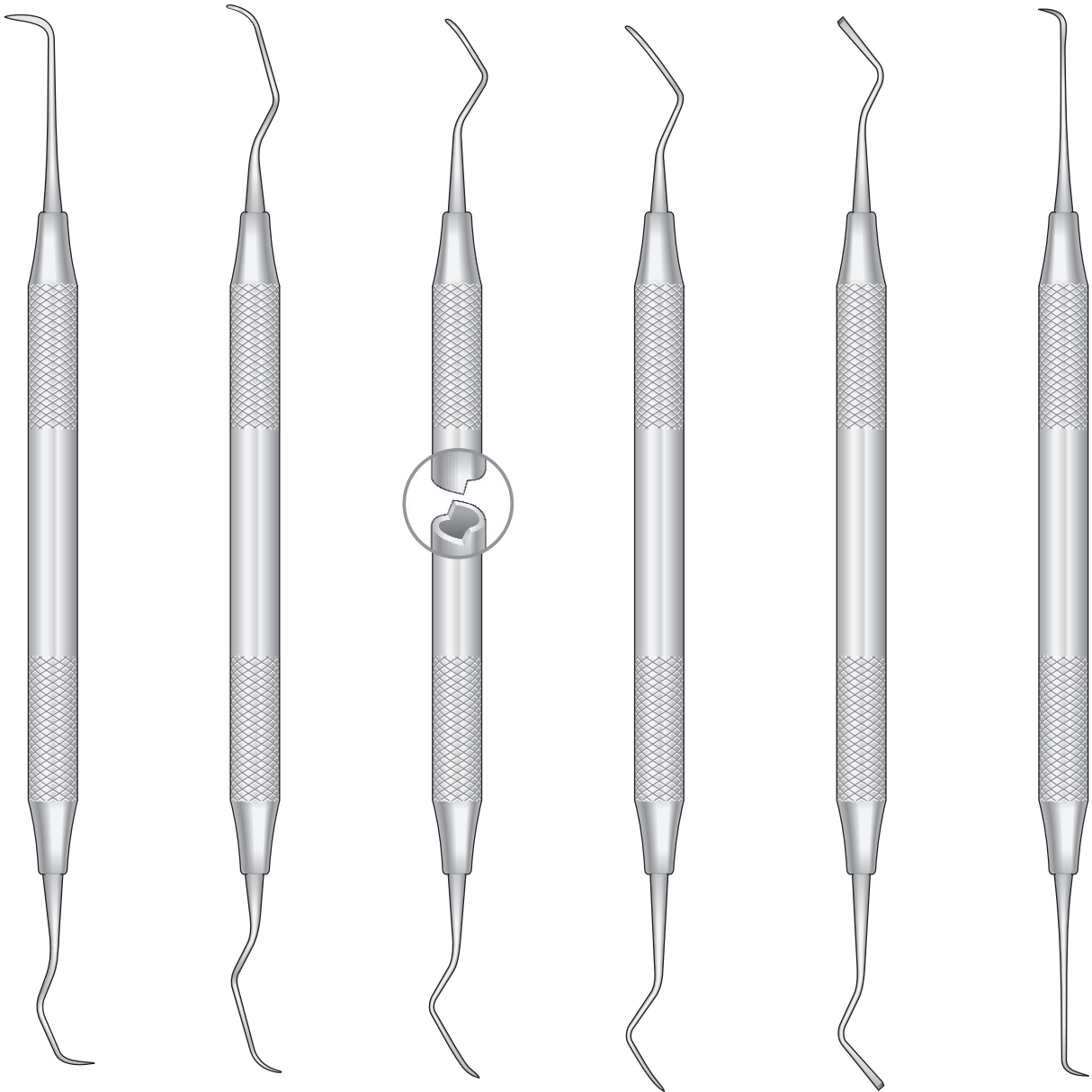

**GOLDMAN-FOX**  
**718-271**  
Fig. 1

**GOLDMAN-FOX**  
**718-272**  
Fig. 2

**GOLDMAN-FOX**  
**718-273**  
Fig. 3

**GOLDMAN-FOX**  
**718-274**  
Fig. 4

**GOLDMAN-FOX**  
**718-275**  
Fig. 5

**GOLDMAN-FOX**  
**718-277**  
Fig. 21

## Scalers and Curettes

Scaler und Küretten  
Scaler e Curette  
Raspadores y Curetas  
Détartreurs et Curettes

## Periodontics / Endodontics / Restoration

Parodontologie / Endodontie / Restauration  
Parodontie / Endodontie / Restauration  
Parodontologia / Endodonzia / Restauro  
Parodontologiya / Endodontiya / Restavratsiya

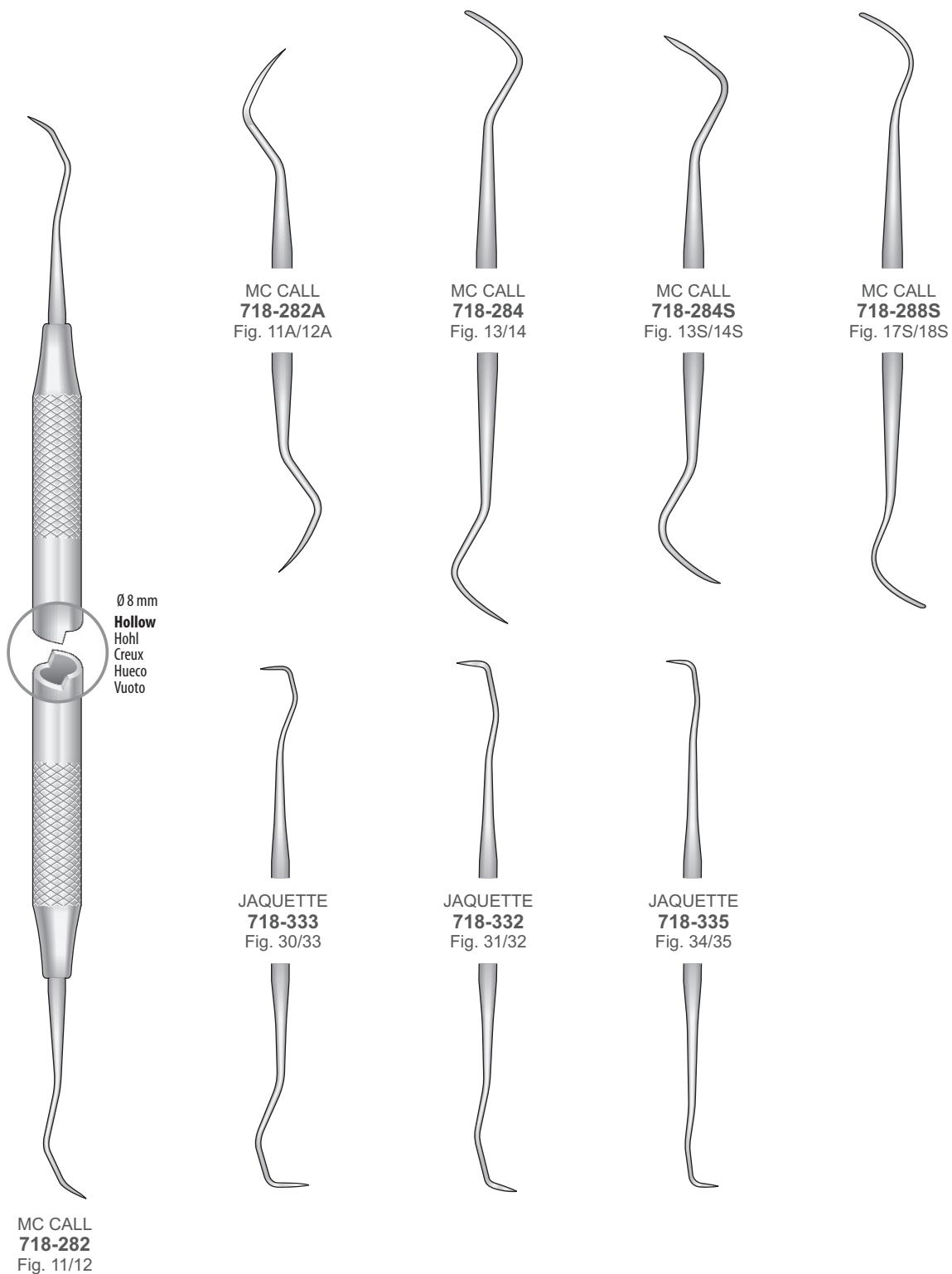

## Scalers and Curettes

Scaler und Küretten  
Scaler e Curette  
Raspadores y Curetas  
Dértartreurs et Curettes

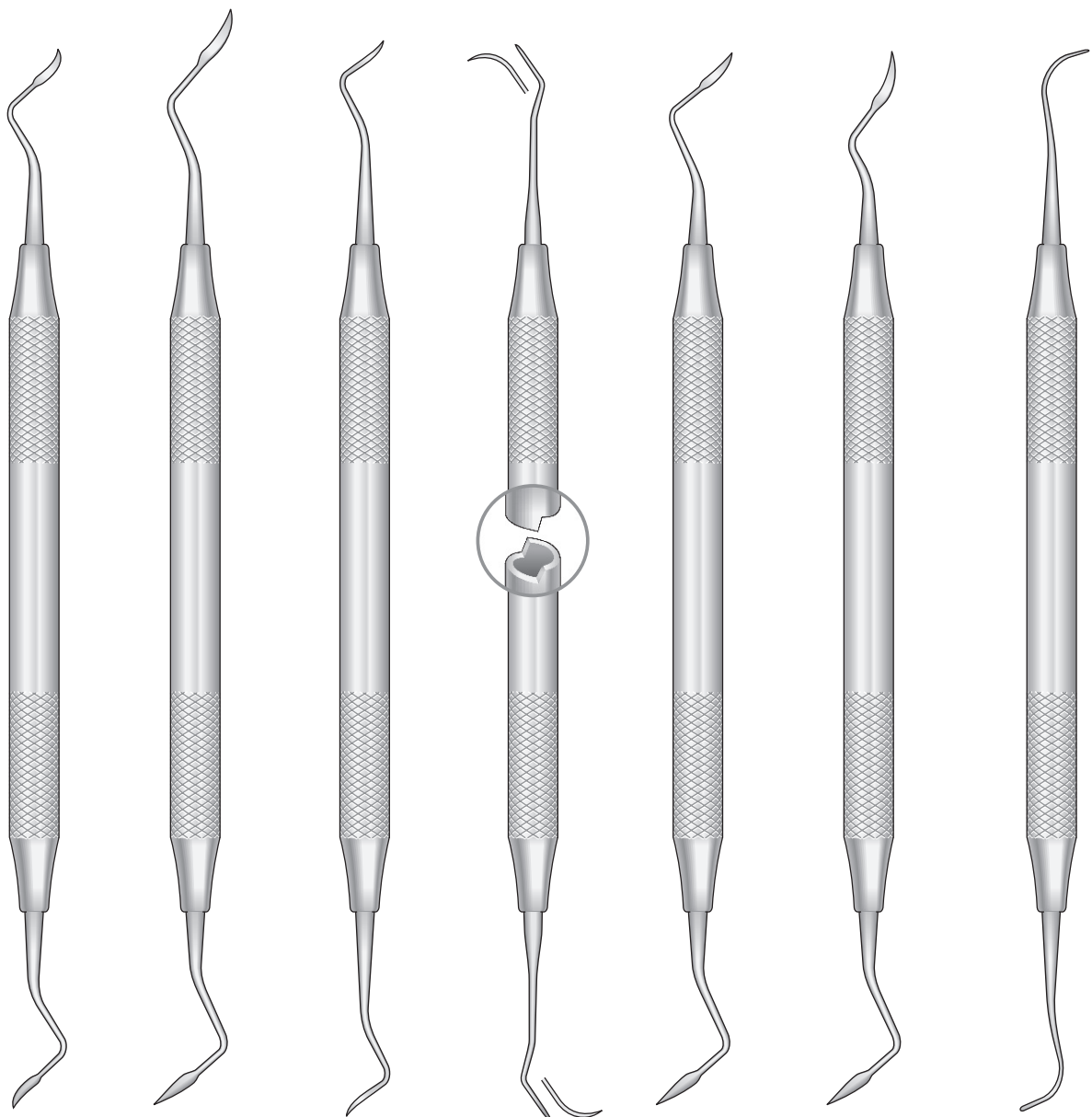

**TAYLOR**  
**718-TO3**  
Fig. 2/3

**718-204**  
Fig. 204

**718-204S**  
Fig. 204S

**718-204SD**  
Fig. 204SD

**718-CIO3**  
Fig. 2/3

**CRANE-CAPLAN**  
**718-CK6**  
Fig. 6

**YOUNGER-GOOD**  
**718-YGO8**  
Fig. 7/8

## Scalers and Curettes

Scaler und Küretten  
Scaler e Curette  
Raspadores y Curetas  
Détartreurs et Curettes

## Periodontics / Endodontics / Restoration

Parodontologie / Endodontie / Restauration  
Parodontie / Endodontie / Restauration  
Parodontologia / Endodonzia / Restauro  
Parodontologiya / Endodontiya / Restavratsiya



RULE 23/24  
**718-RO4**  
Fig. 3 /4



I. UNIVERSITY  
**718-268**  
Fig. 17/18



TOWNER-JAQUETTE  
**719-111**  
Fig. U15/33

Ø 8 mm  
**Hollow**  
Hohl  
Creux  
Hueco  
Vuoto



TOWNER-JAQUETTE  
**719-125**  
Fig. H5/33



TOWNER-JAQUETTE  
**719-126**  
Fig. H6/H7

## Rubber-Dam Instruments

Kofferdam Instrumente

Strumenti per diga

Instrumentos para dique de goma

Instruments pour digue de caoutchouc

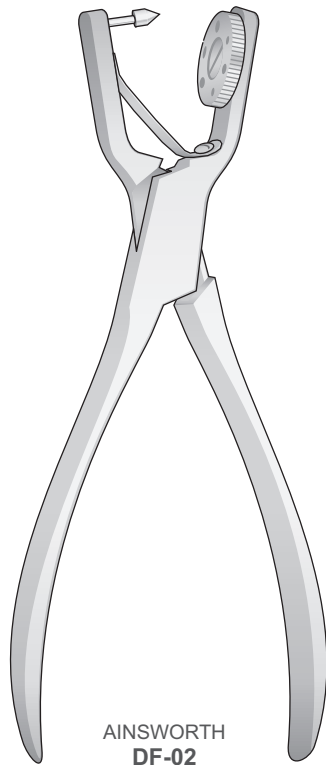

AINSWORTH  
**DF-02**  
160 mm

Lochzangen  
Punch Forceps  
Pinze foradiga  
Perforadores  
Pincas à perforer

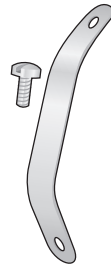

**DF-02M**  
Feder mit Schraube  
Spring with screw  
Molla con vite  
Muelle con tornillo  
Ressort avec vis



**DF-02R**  
Lochscheibe  
Punch Disk  
Disco divisor  
Disco agujereado  
Disque perforé



**DF-02P**  
Stift, mit Schraube  
Pin, with screw  
Perno con vite  
Punzôn con perno  
Broche

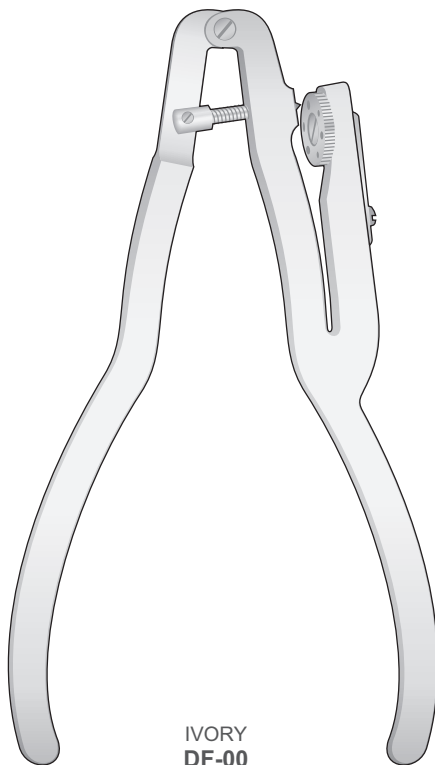

IVORY  
**DF-00**  
160 mm

Lochzangen  
Punch Forceps  
Pinze foradiga  
Perforadores  
Pincas à perforer



**DF-00M**  
Spiralfeder  
Spiral Spring  
Molla a spirale  
Muelle espiral  
Ressort en spirale



**DF-00L + DF-00V**  
Feder mit Schraube  
Spring with screw  
Molla con vite  
Muelle con tornillo  
Ressort avec vis



**DF-00R**  
Lochscheibe  
Punch Disk  
Disco divisor  
Disco agujereado  
Disque perforé



**DF-00P + DF-00N**  
Stift, mit Schraube  
Pin, with screw  
Perno con vite  
Punzôn con perno  
Broche avec vis

## Rubber-Dam Clamp Forceps

Kofferdam-Klammerzangen

Pinze per uncini

Pinzas para grapas dique de goma

Pinces porte-crampons

## Periodontics / Endodontics / Restoration

Parodontologie / Endodontie / Restauration

Parodontie / Endodontie / Restauration

Parodontologia / Endodonzia / Restauro

Parodontologiya / Endodontiya / Restavratsiya

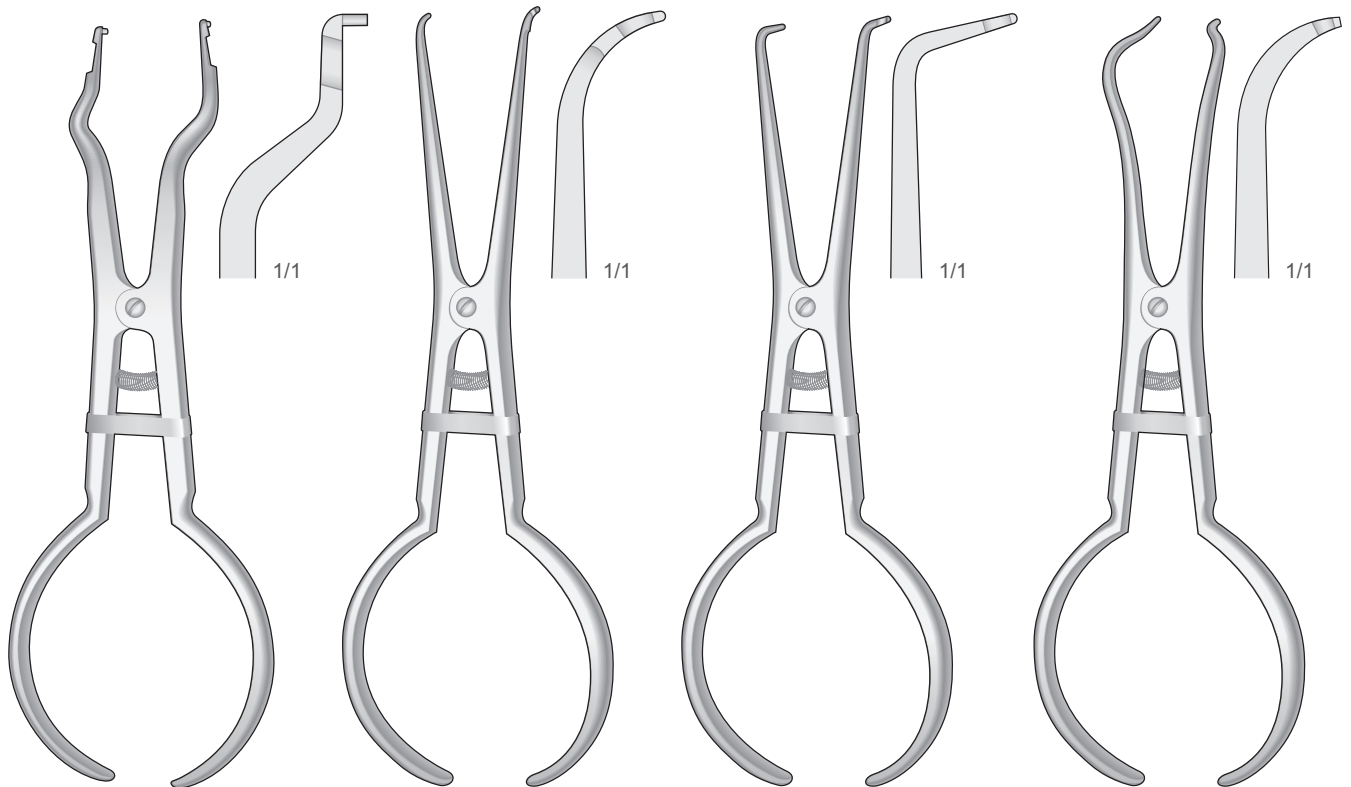

**BREWER**  
**DF-10**  
170 mm

**PALMER**  
**DF-15**  
170 mm

**STOKE**  
**DF-16**  
170 mm

**DF-18**  
170 mm

**Matrix Retainers and Matrix Bands**

Matrizenspanner und Matrizenbänder  
 Portamatrici e matrici  
 Portamatrices y bandas matrices  
 Porte-matrices et bagues matrices

Molaren, 12 Stück  
 Molars, 12 pieces  
 Molari, 12 pezzi  
 Molares, 12 piezas  
 Molaïres, 12 Pièces

Premolaren, 12 Stück  
 Premolars, 12 pieces  
 Premolari, 12 pezzi  
 Premolares, 12 piezas  
 Prémolaires, 12 Pièces



**DF-40/1**  
 Fig.1



**DF-41/4**  
 Fig.4



**DF-40/2**  
 Fig.2



**DF-41/5**  
 Fig.5



**DF-40/3**  
 Fig.3



**DF-41/6**  
 Fig.6

Kofferdam-Klammerzangen  
 Rubber-Dam Clamp Forceps  
 Pinze per uncini  
 Pinzas para grapas dique de goma  
 Pincès porte-crampons

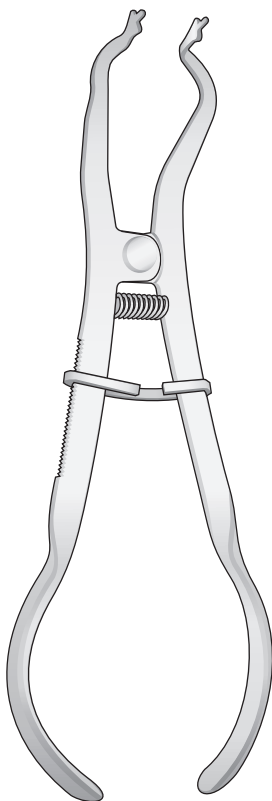

**IVORY**  
**DF-12**  
 170 mm

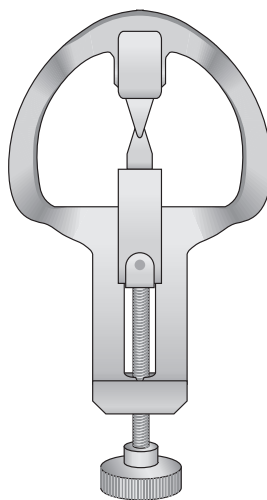

**IVORY**  
**DF-43**  
 Fig. 14

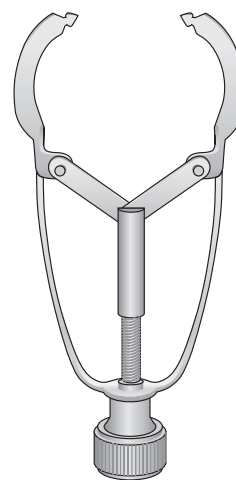

**IVORY**  
**DF-40**  
 Fig. 1

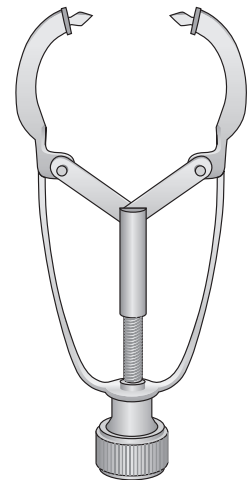

**IVORY**  
**DF-41**  
 Fig. 12

## Rubber-Dam Instruments

Kofferdam Instrumente  
Strumenti per diga  
Instrumentos para dique de goma  
Instruments pour digue de caoutchouc

## Periodontics / Endodontics / Restoration

Parodontologie / Endodontie / Restauration  
Parodontie / Endodontie / Restauration  
Parodontologia / Endodonzia / Restauro  
Parodontologiya / Endodontiya / Restavratsiya

Kofferdam-Klammern  
Rubber-Dam Clamps  
Uncini per diga  
Clamps para diques  
Crampons pour digue



IVORY  
**DF-126**  
# 26



IVORY  
**DF-127**  
# 27



IVORY  
**DF-128**  
# 28



IVORY  
**DF-129**  
# 29



IVORY  
**DF-130**  
# 30



IVORY  
**DF-131**  
# 31



IVORY  
**DF-151**  
# 51



IVORY  
**DF-160**  
# 60

Kofferdam-Rahmen  
Rubber-Dam Frames  
Telaio per diga  
Cuadro para diques  
Cadre à digue



**DF-30**  
80x75 mm  
Kinder  
Children  
Bambini  
Niños  
Enfants

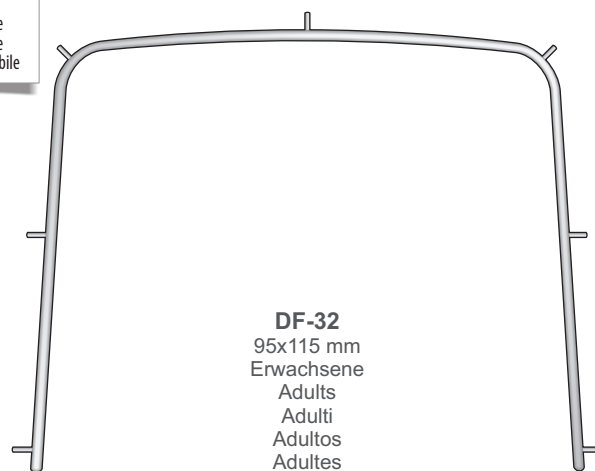

**DF-32**  
95x115 mm  
Erwachsene  
Adults  
Adulti  
Adultos  
Adultes



## Matrix Retainers and Matrix Bands

Matrizenspanner und Matrizenbänder  
 Portamatrici e matrici  
 Portamatrices y bandas matrices  
 Porte-matrices et bagues matrices

Molaren, 12 Stück  
 Molars, 12 pieces  
 Molari, 12 pezzi  
 Molares, 12 piezas  
 Molaires, 12 Pièces

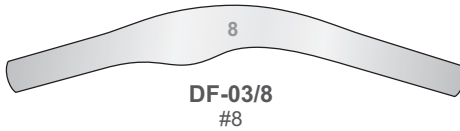

Premolaren, 12 Stück  
 Premolars, 12 pieces  
 Premolari, 12 pezzi  
 Premolares, 12 piezas  
 Prémolaires, 12 Pièces

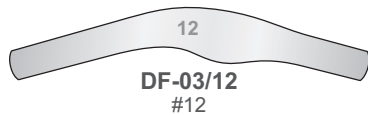

TOFFLEMIRE  
 Universal

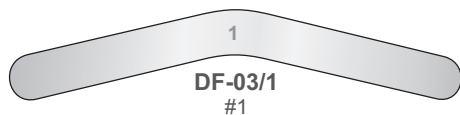

**DF-01/5** 5 mm x 1 mt  
**DF-01/6** 6 mm x 1 mt  
**DF-01/7** 7 mm x 1 mt



**DF-05/5** 5 mm x 5 mt  
**DF-05/6** 6 mm x 5 mt  
**DF-05/7** 7 mm x 5 mt

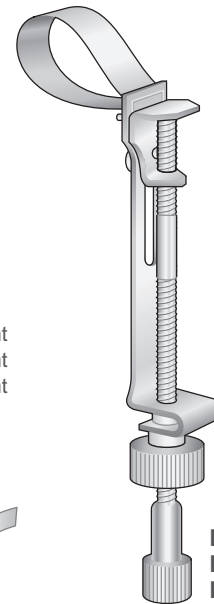

**DF-06** 5 mm  
**DF-08** 6 mm  
**DF-09** 7 mm

IVORY  
**DF-06/DF-09**  
 #8

Paar - Pair  
 Coppia - Par  
 Paire



#1  
 Rechts  
 Right  
 Destra  
 Derecha  
 Droite



#2  
 Links  
 Left  
 Sinistra  
 Izquierda  
 Gauche

NYSTRÖM  
**DF-04**  
 #1 + #2

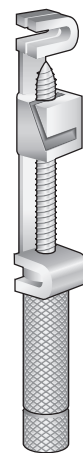

TOFFLEMIRE  
**DF-07**  
 Universal