

# MSB

## IMPLANTOLOGY

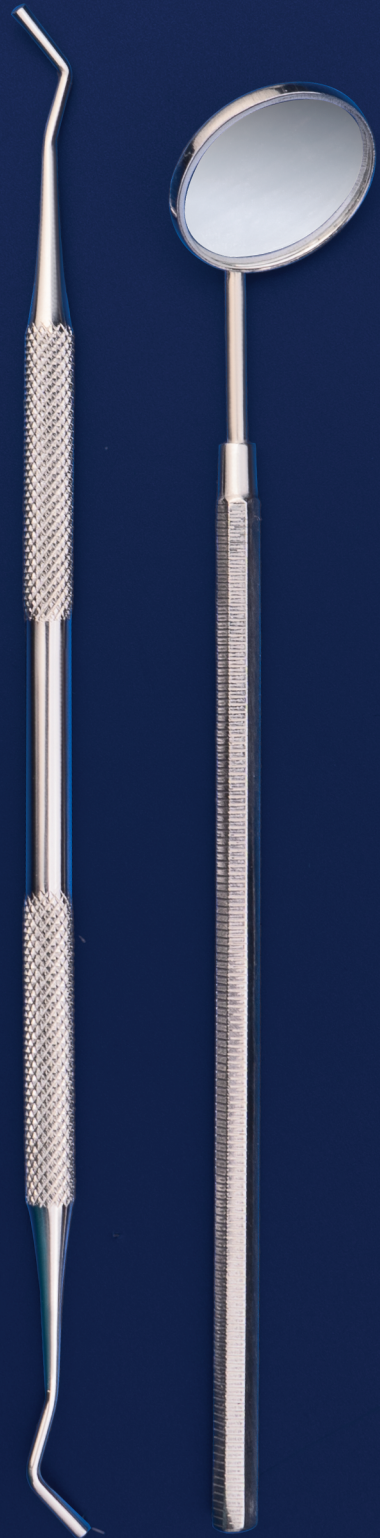

## Osteotomes

Osteotome  
Osteotomi  
Osteótomos  
Ostéotomes

## Implantology

Implantologie  
Implantologie  
Implantologia  
Implantologiya

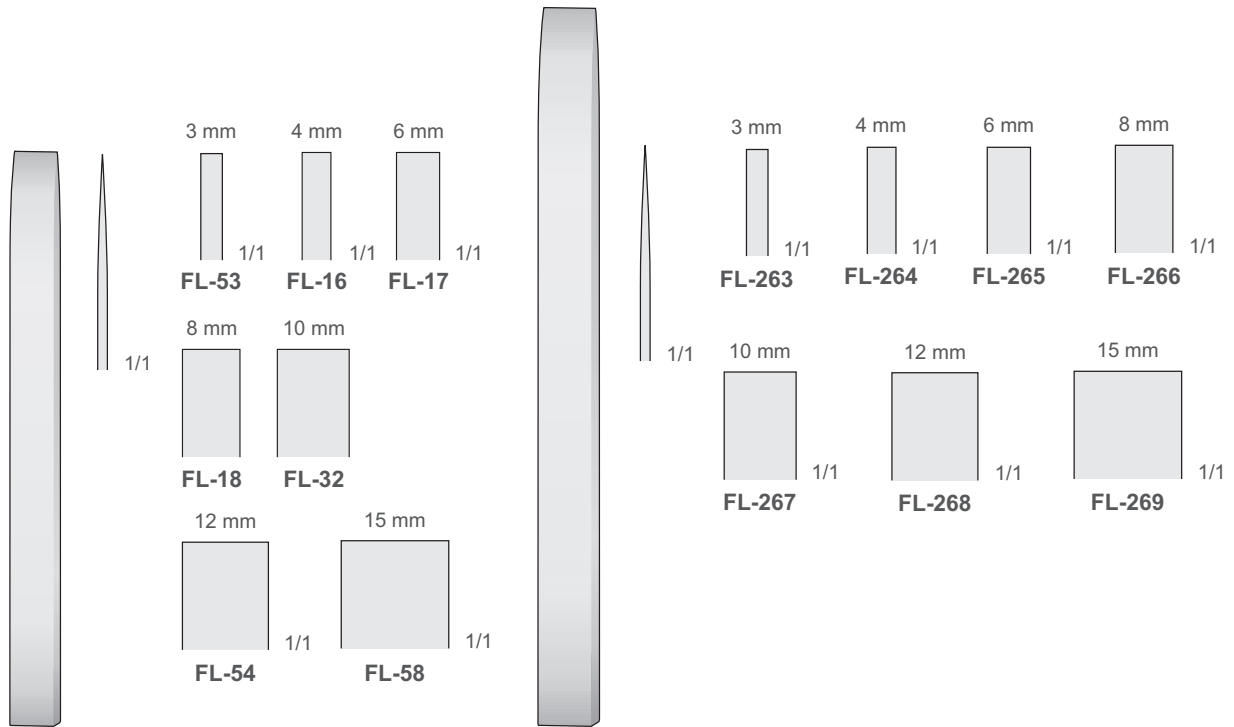

MINI-LAMBOTTE  
**FL-16/FL-58**  
125 mm

MINI-LAMBOTTE  
**FL-263/FL-269**  
170 mm

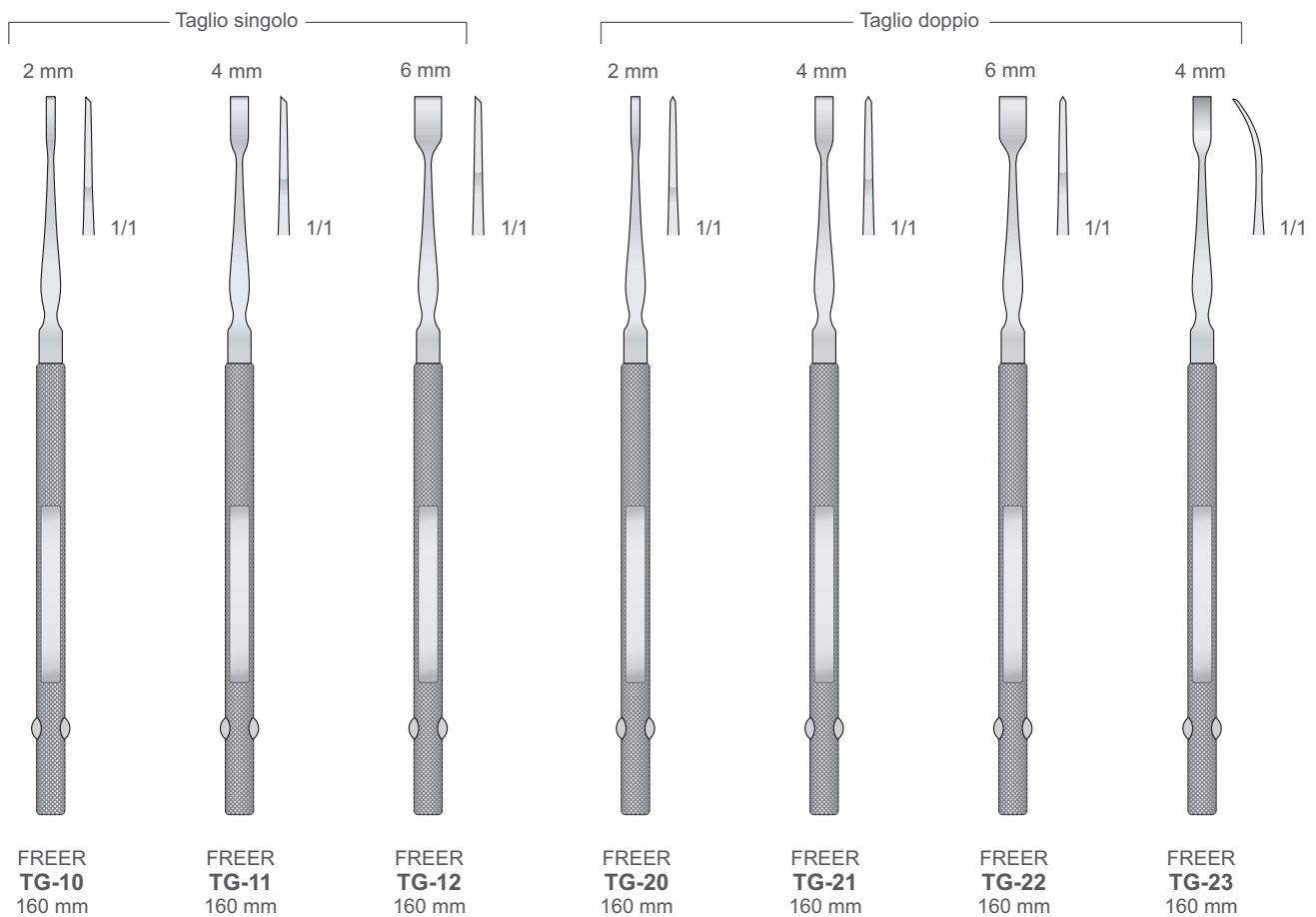

FREER  
**TG-10**  
160 mm

FREER  
**TG-11**  
160 mm

FREER  
**TG-12**  
160 mm

FREER  
**TG-20**  
160 mm

FREER  
**TG-21**  
160 mm

FREER  
**TG-22**  
160 mm

FREER  
**TG-23**  
160 mm

**Osteotomes - Gouges**

Osteotome - Meißel  
 Osteotomi - Sgorbie  
 Osteótomos - Gubias  
 Ostéotomes - Gouges

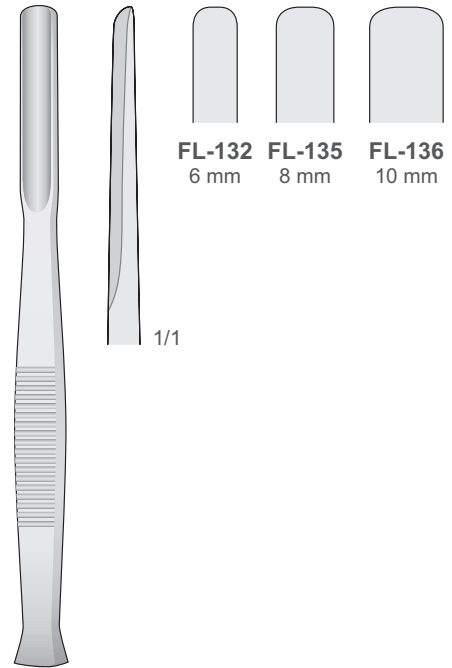
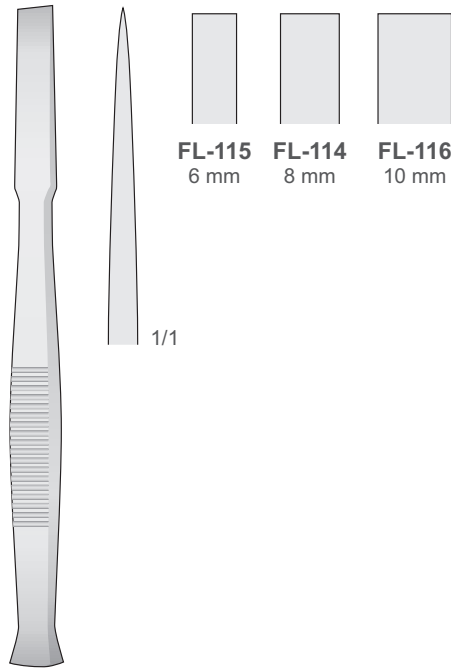

**FL-114/FL-116**  
140 mm

**FL-132/FL-136**  
140 mm

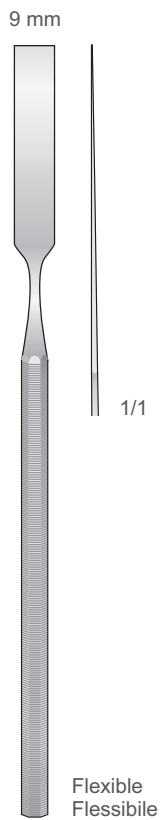

**TG-15**  
170 mm

Flexible  
Flessibile

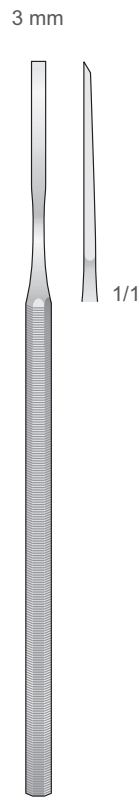

**TG-30**  
155 mm

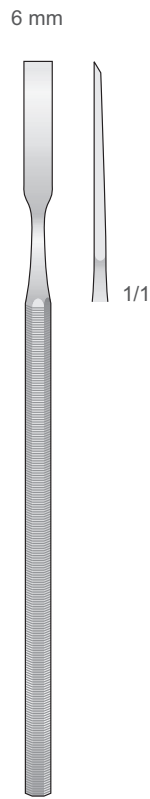

**TG-31**  
155 mm

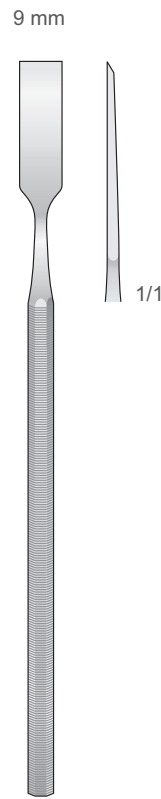

**TG-32**  
155 mm

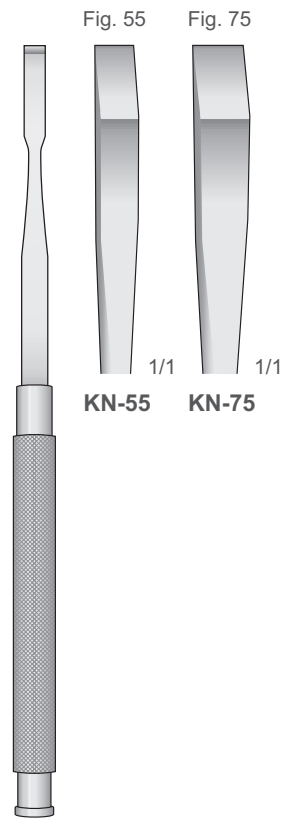

**KRAMER-NEVINS**  
**KN-55/KN-75**  
175 mm

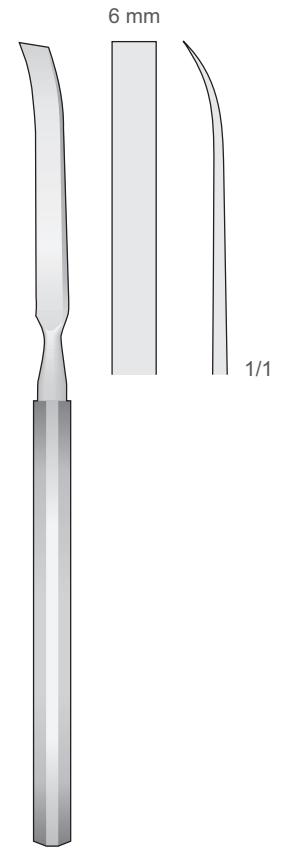

**DO-196**  
180 mm

## Osteotomes - Gouges

Osteotome - Meißel  
 Osteotomi - Sgorbie  
 Osteótomos - Gubias  
 Ostéotomes - Gouges

## Implantology

Implantologie  
 Implantologie  
 Implantologia  
 Implantologiya

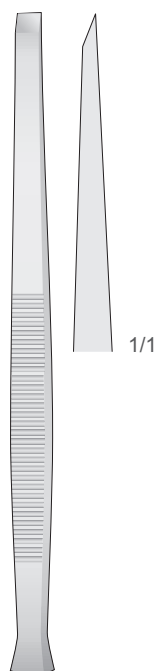

PARTSCH  
**FL-13/FL-15**  
 140 mm



**FL-13**  
 3 mm



**FL-14**  
 4 mm



**FL-15**  
 5 mm

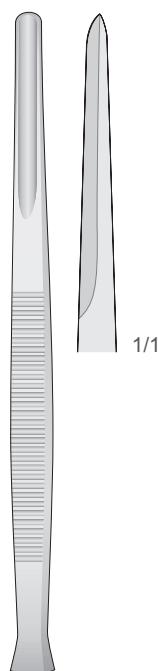

PARTSCH  
**FL-03/FL-05**  
 140 mm



**FL-03**  
 3 mm



**FL-04**  
 4 mm



**FL-05**  
 5 mm

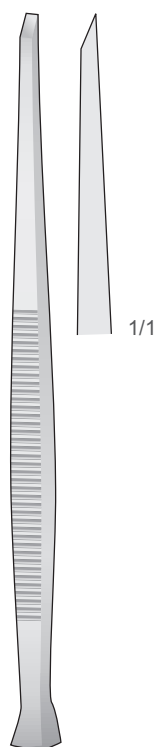

PARTSCH  
**FL-177/FL-184**  
 170 mm



**FL-177**  
 3 mm



**FL-183**  
 6 mm



**FL-179**  
 4 mm



**FL-184**  
 7 mm



**FL-181**  
 5 mm

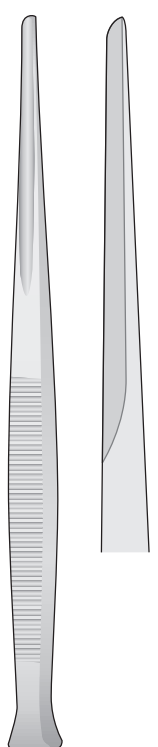

PARTSCH  
**FL-185/FL-189**  
 170 mm



**FL-185**  
 3 mm



**FL-188**  
 6 mm



**FL-186**  
 4 mm



**FL-189**  
 7 mm



**FL-187**  
 5 mm

## Osteotomes - Chisels

Osteotome - Meissel  
 Osteotomi - Scalpelli  
 Osteótomos - Cinceles  
 Ostéotomes - Burins

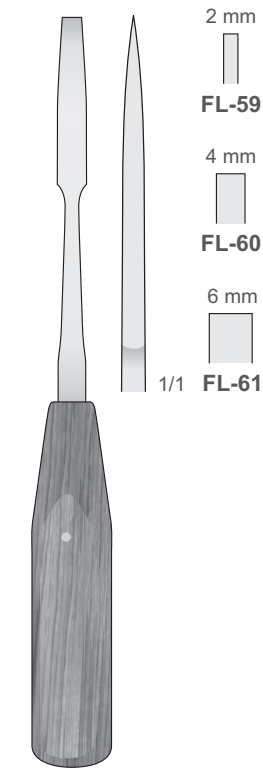

MINI-LEXER  
**FL-59/FL-61**  
 200 mm

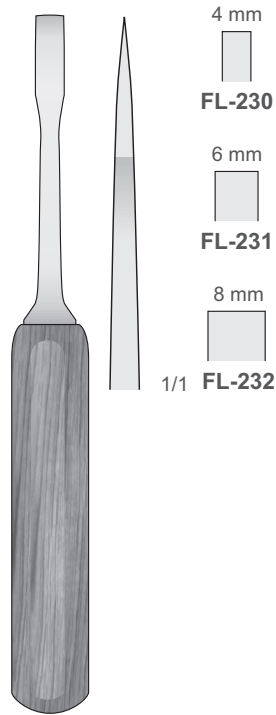

MINI-LEXER  
**FL-230/FL-232**  
 180 mm

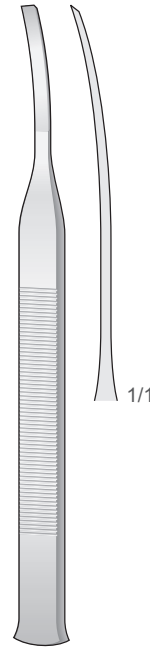

TESSIER  
**FL-411 5 mm**  
**FL-412 7 mm**  
 160 mm

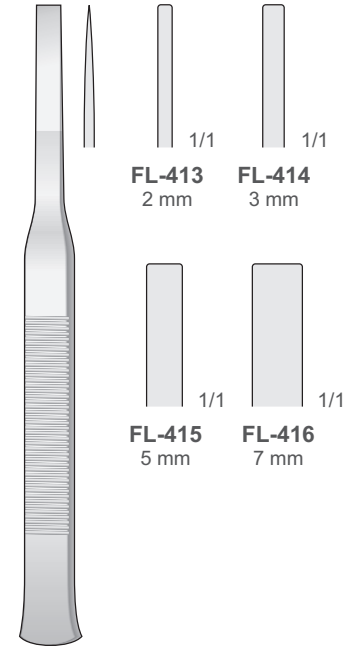

TESSIER  
**FL-413/FL-416**  
 160 mm

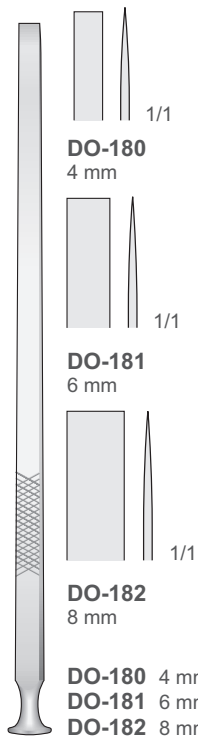

EPKER  
**DO-180/DO-182**  
 180 mm

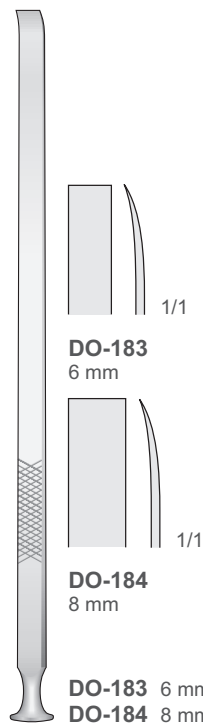

EPKER  
**DO-183/DO-184**  
 180 mm

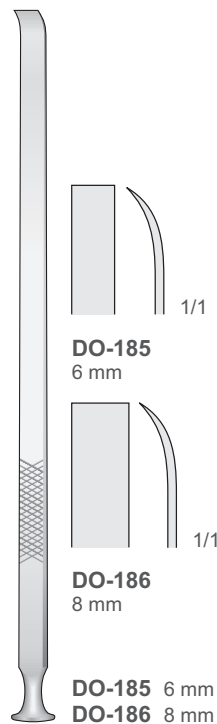

EPKER  
**DO-185/DO-186**  
 180 mm

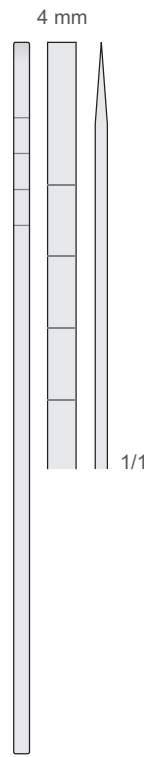

COTTLE  
**DO-140**  
 180 mm

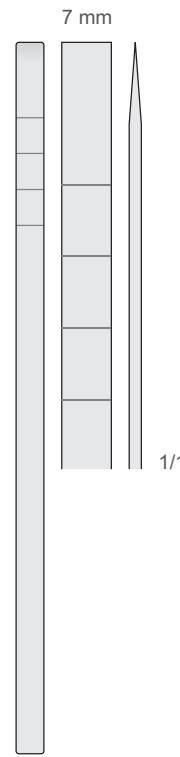

COTTLE  
**DO-141**  
 180 mm

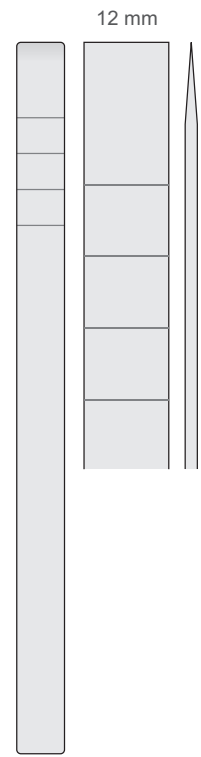

COTTLE  
**DO-143**  
 180 mm

## Surgical mallets

Chirurgische Hämmer  
Martelli chirurgici  
Martillos quirúrgicos  
Maillets chirurgicaux

## Implantology

Implantologie  
Implantologie  
Implantologia  
Implantologiya

Martelli chirurgici  
Martillos quirúrgicos  
Maillets chirurgicaux

Ø 20 mm - 140 g



**FL-01**  
165 mm

Ø 25 mm - 300 g

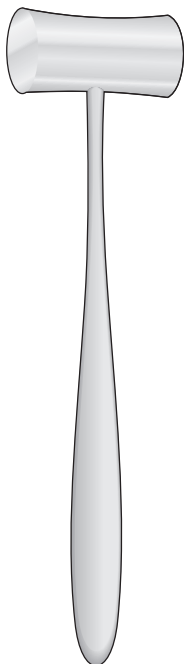

**LUCAE  
FL-10M**  
190 mm

Ø 27 mm - 135 g

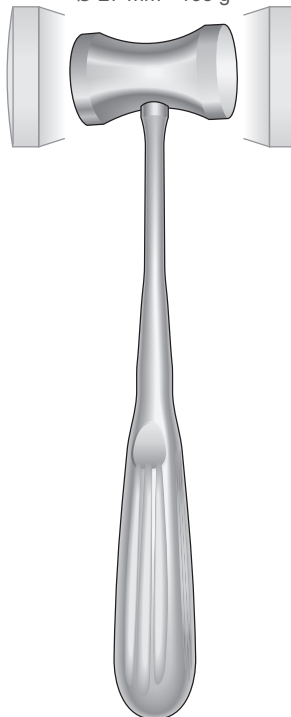

**HAJEK  
FL-128**  
200 mm

Ø 30 mm - 240 g

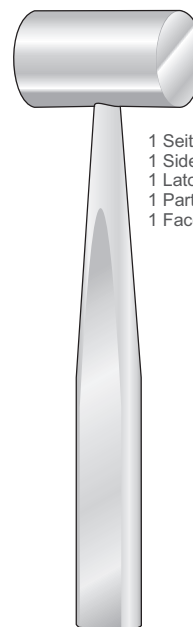

1 Seite flach - 1 Seite convex  
1 Side flat - 1 Side convex  
1 Lato piatto - 1 Lato convesso  
1 Parte plana - 1 Parte convexa  
1 Face plate - 1 Face convexe

**COTTLE  
FL-104**  
185 mm

Ø 20 mm - 160 g

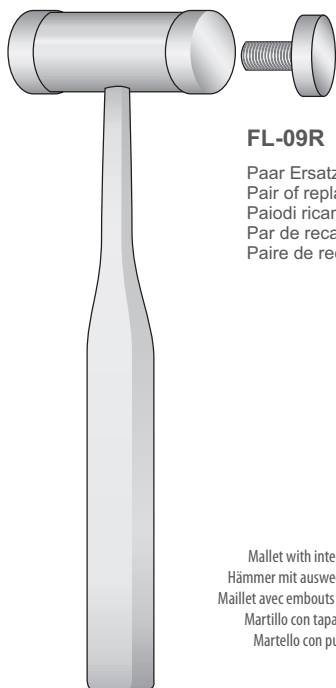

**FL-09R**

Paar Ersatzbacken  
Pair of replacement  
Paiodi ricambio  
Par de recambio  
Paire de rechange

**MEAD  
FL-09**  
190 mm

Ø 25 mm - 200 g

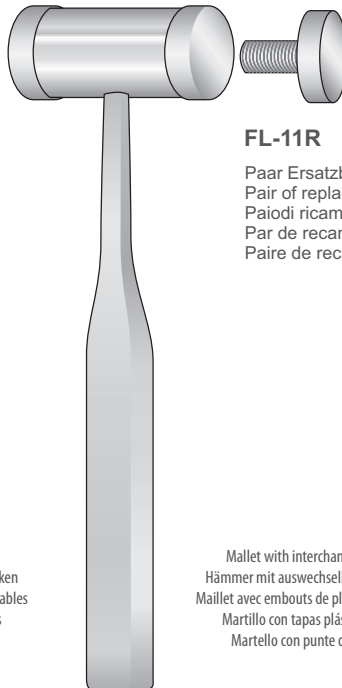

**FL-11R**

Paar Ersatzbacken  
Pair of replacement  
Paiodi ricambio  
Par de recambio  
Paire de rechange

**MEAD  
FL-11**  
200 mm

Ø 26 mm - 320 g

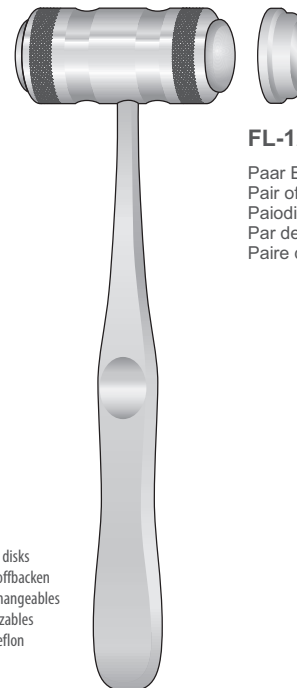

**FL-12R**

Paar Ersatzbacken  
Pair of replacement  
Paiodi ricambio  
Par de recambio  
Paire de rechange

**MEAD  
FL-12**  
190 mm

Mallet with interchangeable plastic disks  
Hämmer mit auswechselbaren Kunststoffbacken  
Maillet avec embouts de plastique interchangeables  
Martillo con tapas plásticas reemplazables  
Martello con punte di ricambi in teflon

Mallet with interchangeable plastic disks  
Hämmer mit auswechselbaren Kunststoffbacken  
Maillet avec embouts de plastique interchangeables  
Martillo con tapas plásticas reemplazables  
Martello con punte di ricambi in teflon

**Periosteals**

- Raspatorien
- Scollaperiosteel
- Periostótomos
- Rugines

Sinus Lift Retraktoren - Sinus Lift Retractors  
 Divaricatori per Sinus Lift - Separadores para Sinus Lift  
 Écarteurs pour Sinus Lift

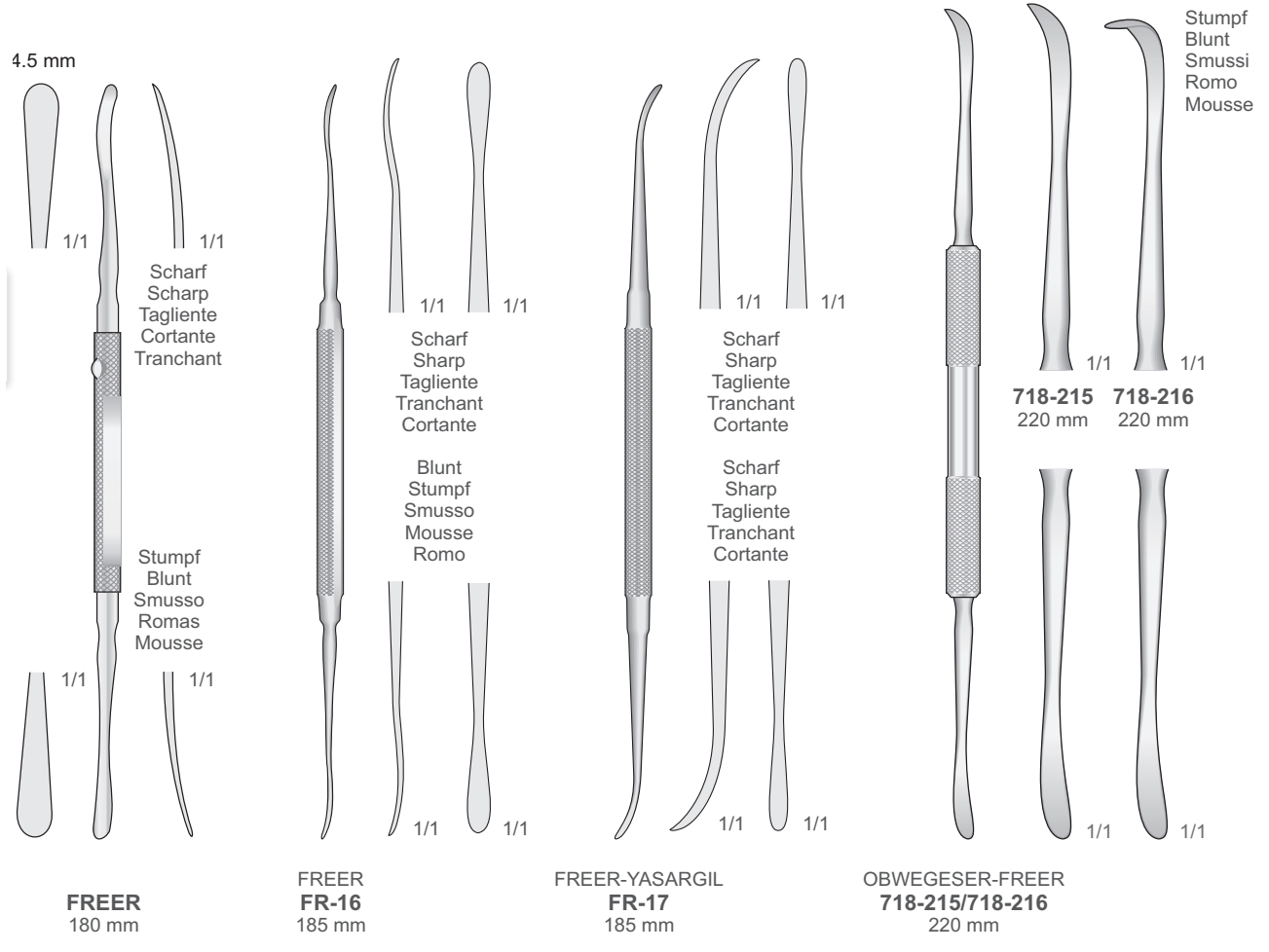
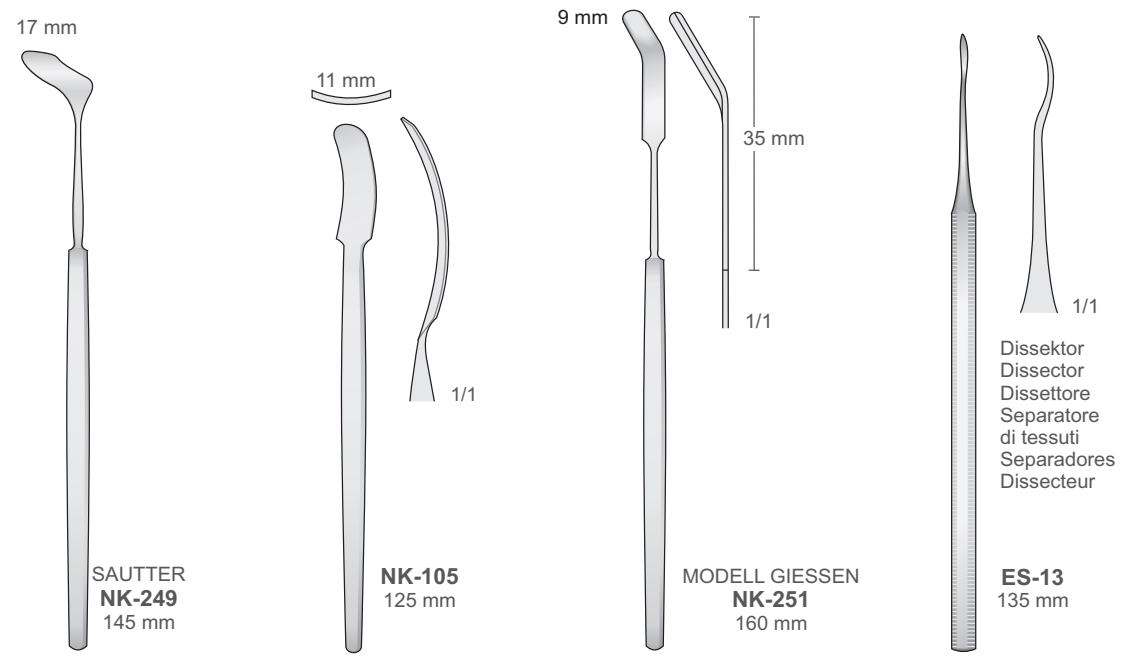

## Trephines

Trepanbohrer  
Trephine  
Trépanos  
Trépan

## Implantology

Implantologie  
Implantologie  
Implantologia  
Implantologiya

### Combination Trocar-Trephine Instruments

Bestehend aus einem Trokar, einer gezahnten Trephine und einem Kolben zur Entnahme von Knochen transplantaten aus Tibia und Beckenkamm mittels eines geschlossenen Verfahrens

Consisting of trocar, a toothed trephine and a plunger for taking tibial and iliac bone grafts through a closed technique

Composto di un trequarti, una camicia dentata ed un pistone per il prelievo degli innesti ossei dalla tibia e dalla cresta iliaca tramite una tecnica chirurgica intracutanea

Compuesto por un trócar, un trépano dentado y un émbolo para obtener injertos óseos tibiales e iliacos mediante una técnica cerrada

Composé d'un trocart, d'une tréphine dentée et d'un piston pour le prélèvement de greffes osseuses de la tibia ou de la crête iliaque par une technique fermée

### FK-100

Komplettset mit 4 Teilen  
Set complete with 4 pieces  
Set completo di 4 pezzi  
Set completo con 4 piezas  
Set complet avec 4 pièces

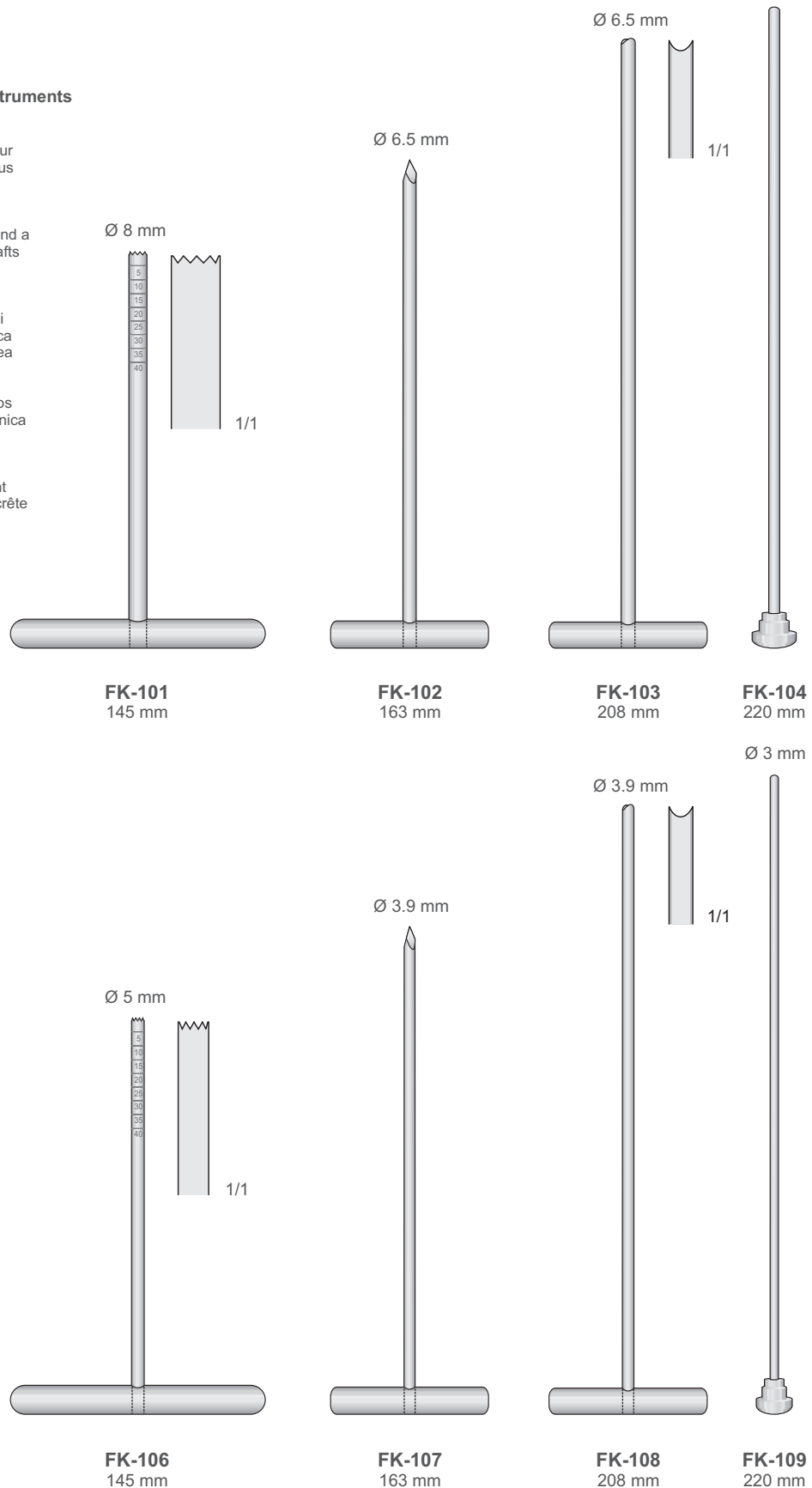

### FK-105

Komplettset mit 4 Teilen  
Set complete with 4 pieces  
Set completo di 4 pezzi  
Set completo con 4 piezas  
Set complet avec 4 pièces

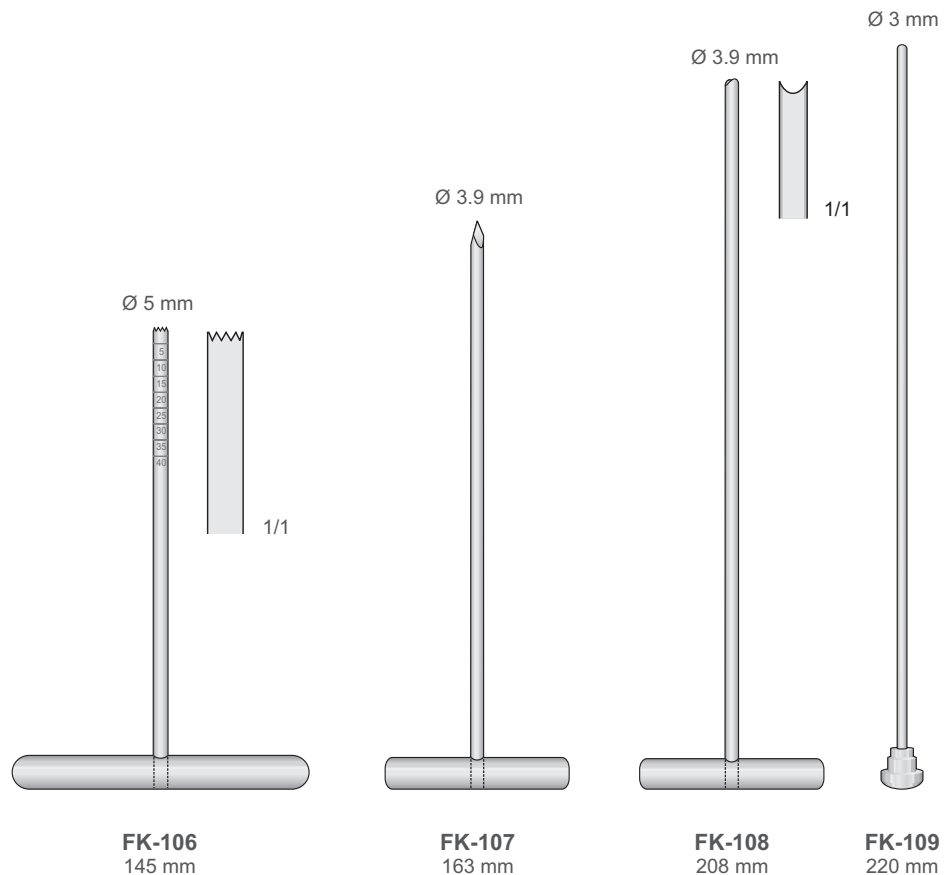



## Implantology Instruments

Implantologie Instrumente  
Strumenti per implantologia  
Instrumentos para Implantología  
Instruments pour Implantologie

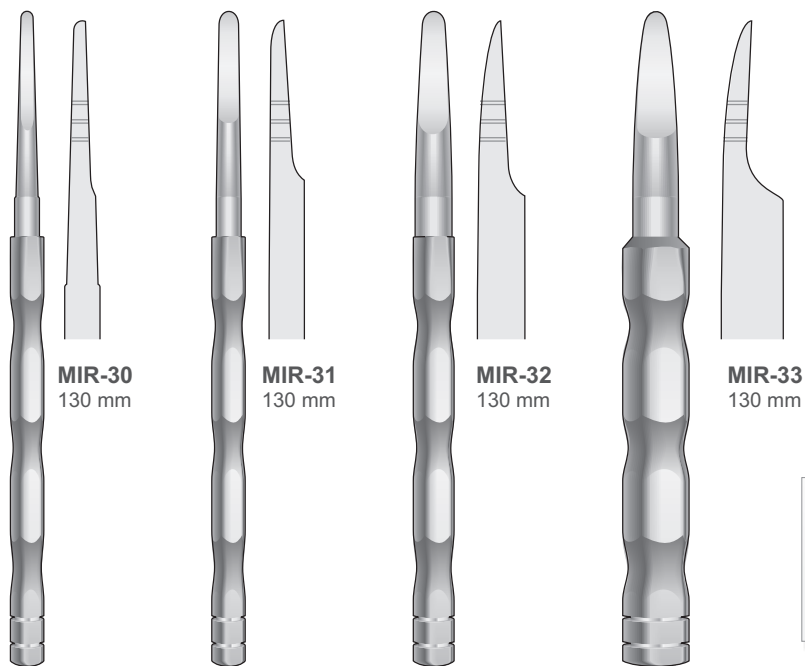

**BONE EXPANDERS**  
Distraktoren für Knochenleiste  
Distracteurs de crête osseuse  
Expansores de cresta ósea  
Distrattori per cresta ossea

## TUNNELING INSTRUMENTS

Tunnelierinstrumente | Instruments pour tunnellation | Instrumentos para tunelización | Strumenti per tunneling

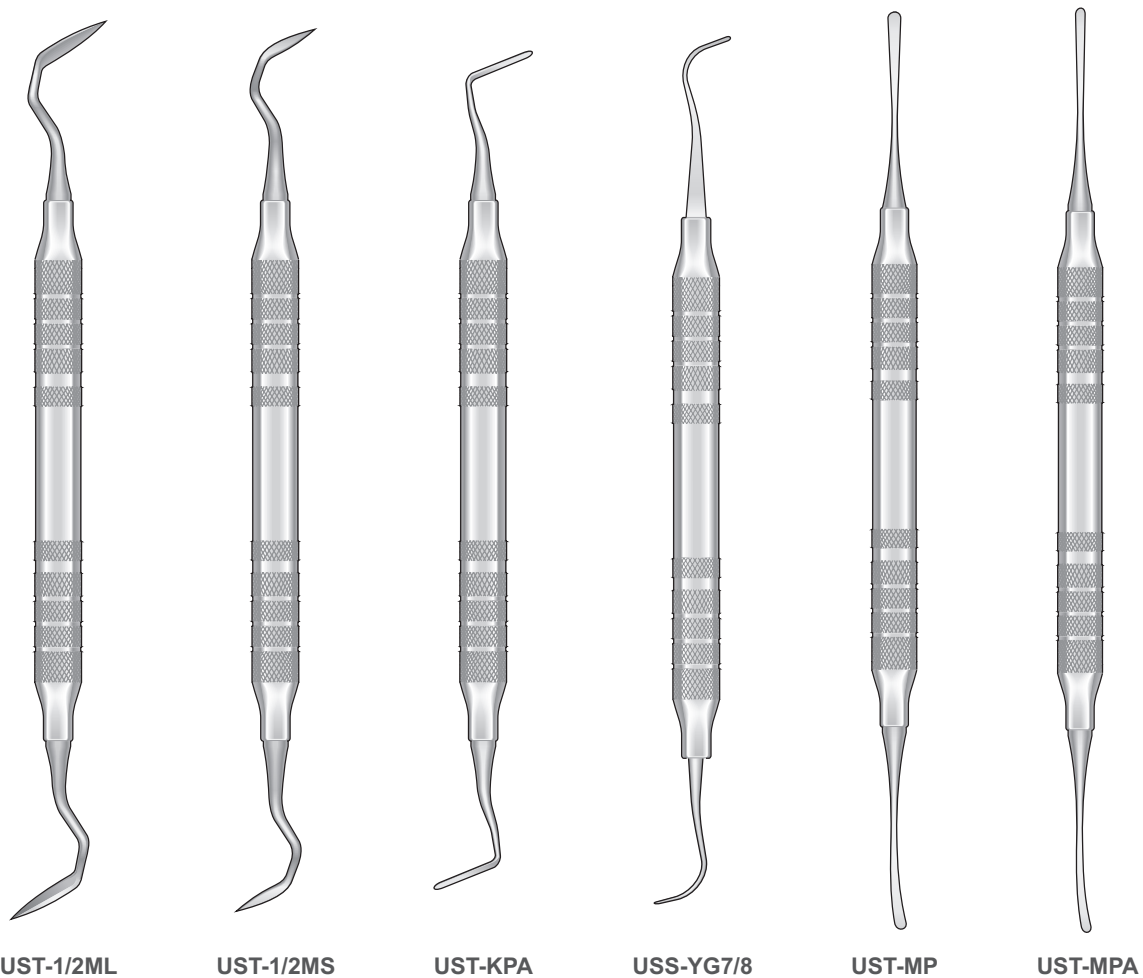

## Osteotomes

Osteotome  
Osteotomi  
Osteótomos  
Ostéotomes

## Implantology

Implantologie  
Implantologie  
Implantologia  
Implantologiya

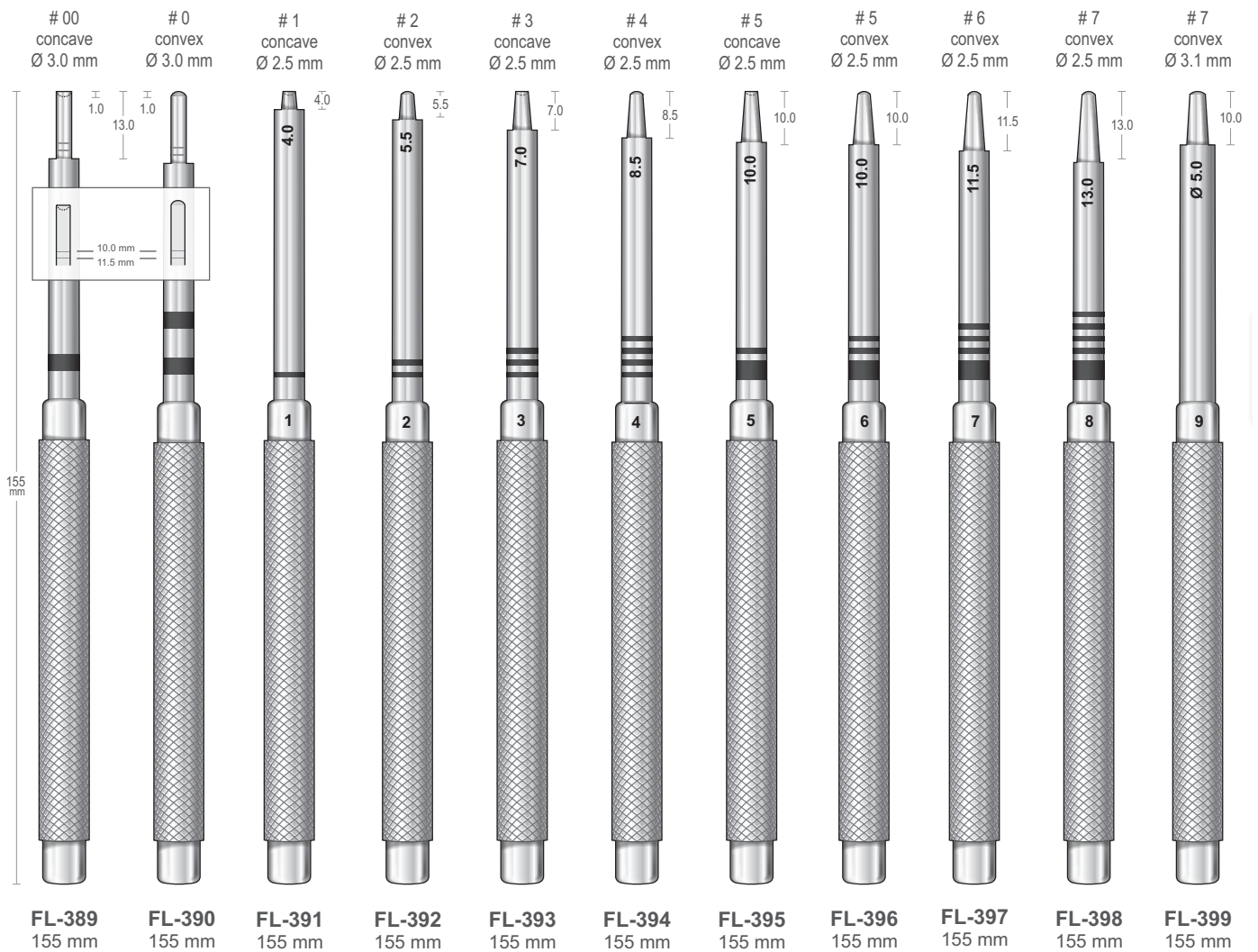

## Osteotomes

Osteotome  
Osteotomi  
Osteótomos  
Ostéotomes

# 1	Diam.
0	Ø 1.60
7.5	Ø 1.80
10	Ø 2.00
13.5	Ø 2.40
15.5	Ø 3.60

# 2	Diam.
0	Ø 1.90
7.5	Ø 2.20
10	Ø 2.35
13.5	Ø 3.30
15.5	Ø 3.40
23.5	Ø 4.50

# 3	Diam.
0	Ø 2.80
7.5	Ø 3.20
10.5	Ø 3.35
13.5	Ø 3.60
21	Ø 4.40

# 4	Diam.
0	Ø 3.10
7.5	Ø 3.70
10.5	Ø 3.90
15.5	Ø 4.30

# 5	Diam.
0	Ø 3.90
10	Ø 5.00
13	Ø 5.20
20.5	Ø 6.30

# 6	Diam.
0	Ø 5.50
10	Ø 6.20
13	Ø 6.30

# 1  
Ø 1.6 mm



**FL-120**  
155 mm

# 2  
Ø 1.9 mm



**FL-121**  
155 mm

# 3  
Ø 2.8 mm



**FL-122**  
155 mm

# 4  
Ø 3.10 mm



**FL-123**  
155 mm

# 5  
Ø 3.90 mm



**FL-124**  
155 mm

# 6  
Ø 5.50 mm



**FL-125**  
155 mm

## Osteotomes

Osteotome  
Osteotomi  
Osteótomos  
Ostéotomes

## Implantology

Implantologie  
Implantologie  
Implantologia  
Implantologiya

# 1	Diam.	# 2	Diam.	# 3	Diam.	# 4	Diam.	# 5	Diam.
0	Ø 1.50	0	Ø 2.10	0	Ø 2.60	0	Ø 3.00	0	Ø 3.50
5	Ø 1.90	5	Ø 2.60	5	Ø 3.00	5	Ø 3.50	5	Ø 3.90
8	Ø 2.20	8	Ø 2.80	8	Ø 3.30	8	Ø 3.80	8	Ø 4.20
10	Ø 2.40	10	Ø 3.00	10	Ø 3.50	10	Ø 4.00	10	Ø 4.40
12	Ø 2.60	12	Ø 3.20	12	Ø 3.70	12	Ø 4.20	12	Ø 4.60
14	Ø 2.80	14	Ø 3.40	14	Ø 3.90	14	Ø 4.40	14	Ø 4.80

Straight  
Gerade  
Droit  
Recto  
Diritto

Bone Pusher

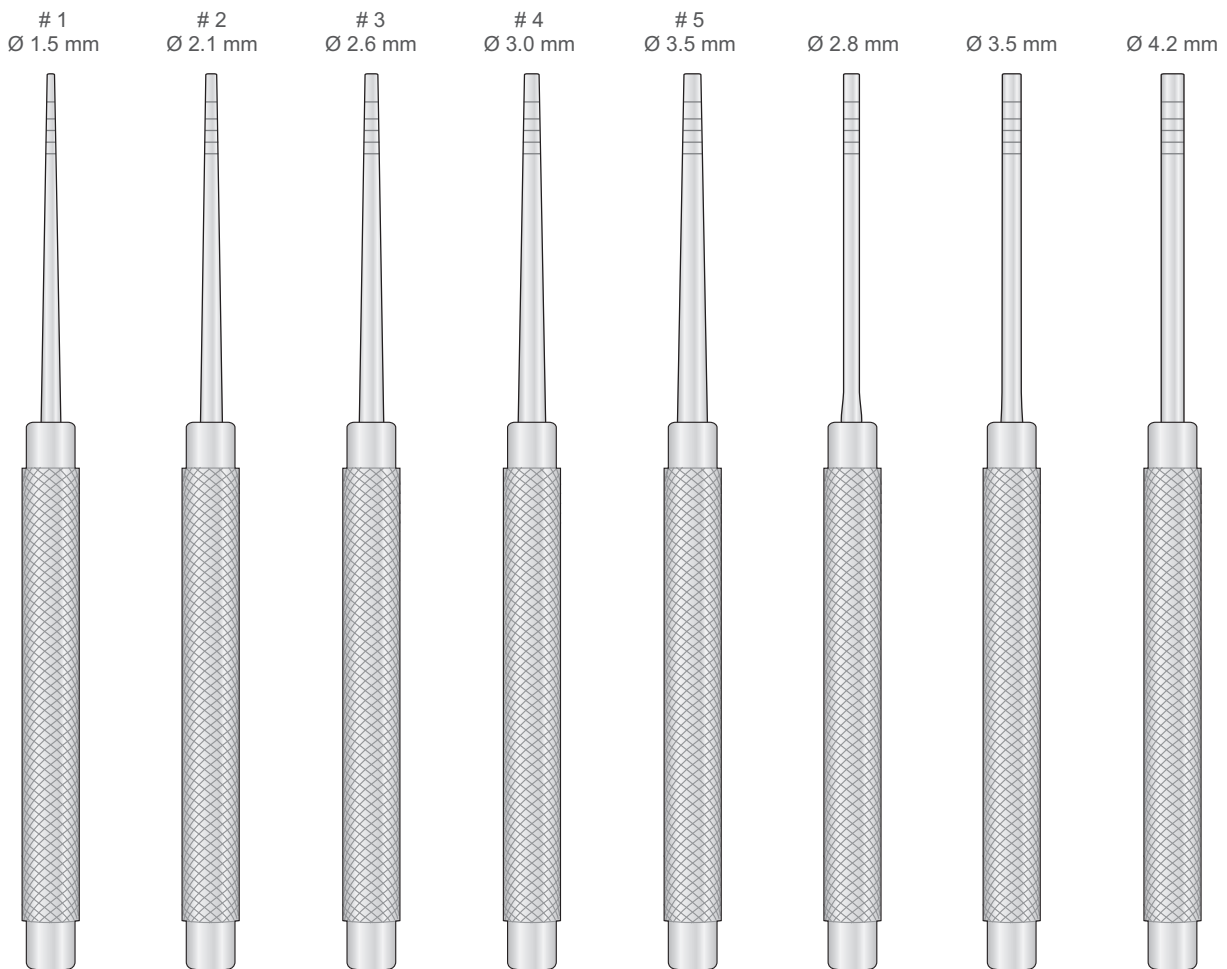

**FL-292**  
55 mm

**FL-293**  
155 mm

**FL-294**  
155 mm

**FL-295**  
155 mm

**FL-296**  
155 mm

**FL-297**  
155 mm

**FL-298**  
155 mm

**FL-299**  
155 mm

## Osteotomes

Osteotome  
Osteotomi  
Osteótomos  
Ostéotomes

Meißeln Graduiert  
Graduated Chisels  
Scalpelli graduati  
Cinceles graduados  
Burins gradués

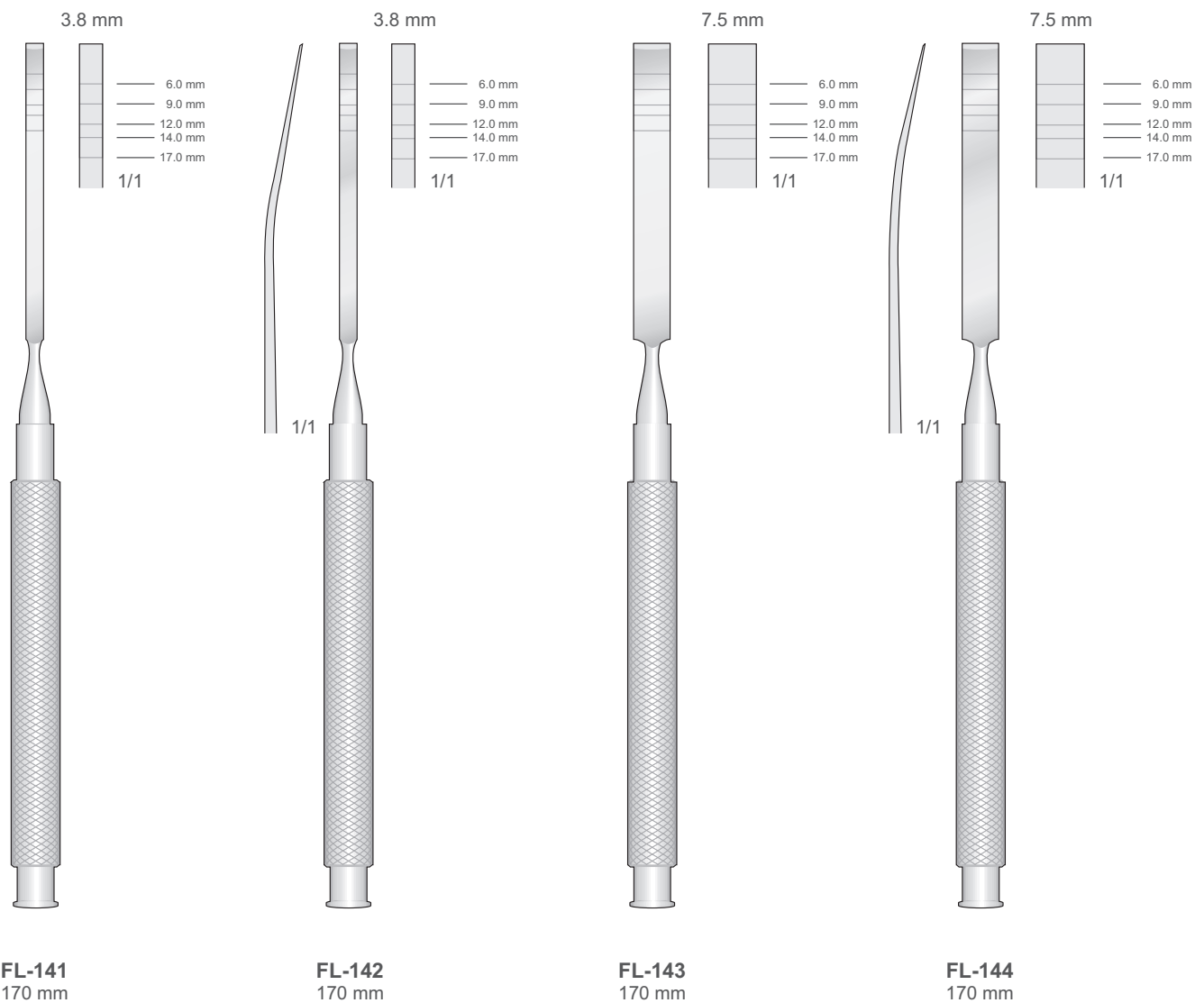

## Osteotomes

Osteotome  
Osteotomi  
Osteótomos  
Ostéotomes

## Implantology

Implantologie  
Implantologie  
Implantologia  
Implantologiya

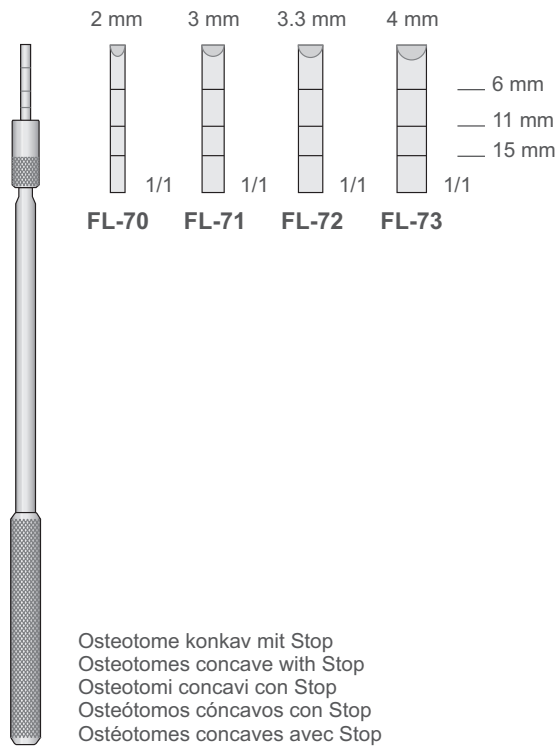

**FL-70/FL-73**  
165 mm

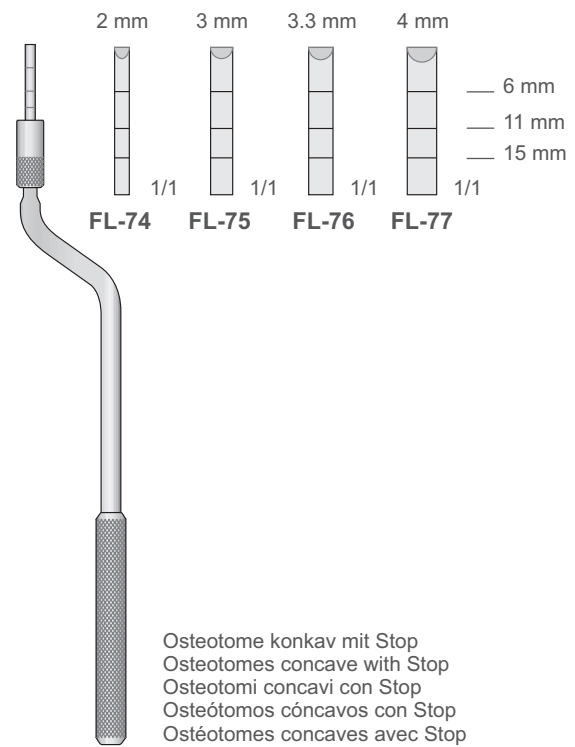

**FL-74/FL-77**  
165 mm

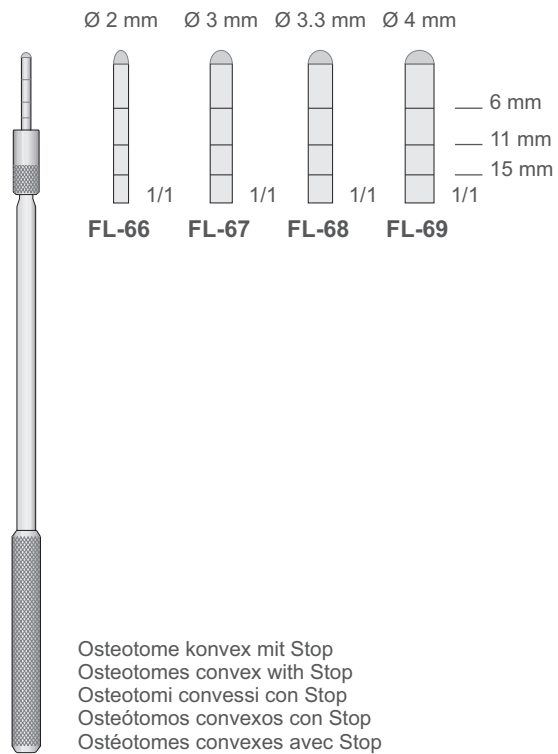

**FL-66/FL-69**  
165 mm

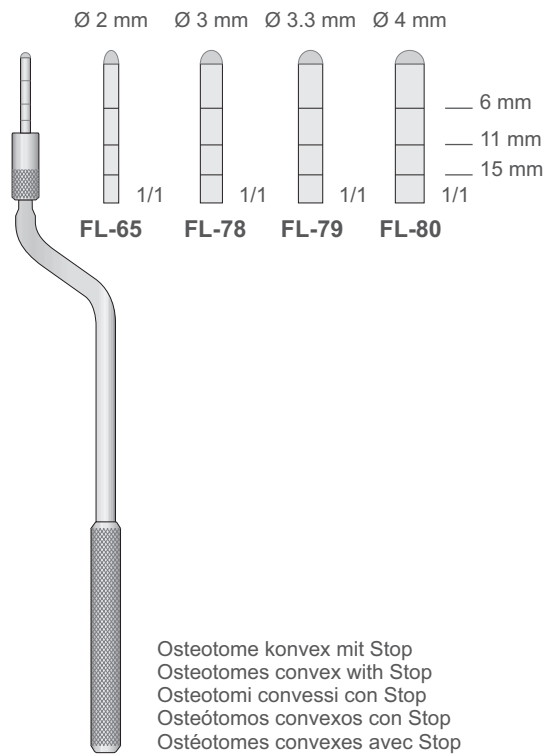

**FL-65/FL-80**  
160 mm

## Osteotomes

Osteotome  
Osteotomi  
Osteótomos  
Ostéotomes

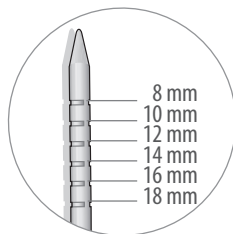

Dilatator  
Dilator  
Dilatatori  
Dilatador  
Dilateur

**A-Form**

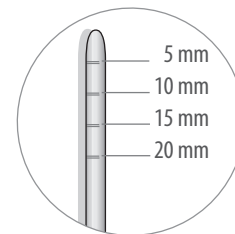

Spreader  
Spreader  
Expansori  
Expansor  
Expandeur

**D-Form  
Convex Tip**

Ø 2 mm

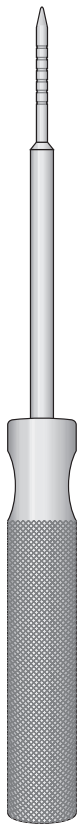

**FL-25**  
145 mm

Ø 3 mm



**FL-26**  
145 mm

Ø 3.3 mm



**FL-27**  
145 mm

Ø 4 mm



**FL-28**  
145 mm

Ø 3 mm



**FL-37**  
145 mm

Ø 4 mm



**FL-38**  
145 mm

Ø 5 mm



**FL-39**  
145 mm

## Trephines

Trepanbohrer  
Trepine  
Trépanos  
Trépan

## Implantology

Implantologie  
Implantologie  
Implantologia  
Implantologiya

For Tissue  
Für Gewebe  
Pour tissu  
Para tejido  
Per tessuto

Nicht Gezahnt  
Non Serrated  
No dentellato  
No dentado  
Non dentelé

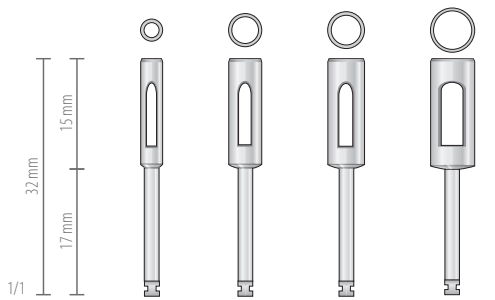

Ø mm	GA-63	GA-64	GA-65	GA-66
Int.	2.5	4.0	4.5	5.5
Ext.	3.0	4.5	5.0	6.0

For Bone  
Für Knochen  
Pour os  
Para hueso  
Per osso

Gezahnt  
Serrated  
Dentellato  
Dentado  
Dentelé

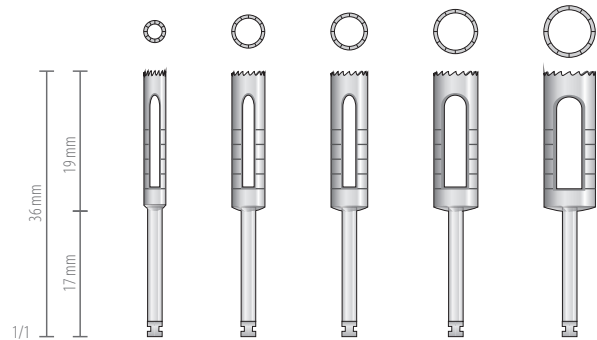

Ø mm	GA-33	GA-34	GA-35	GA-36	GA-37
Int.	2.5	4.0	4.5	5.5	6.5
Ext.	3.0	4.5	5.0	6.0	7.0

Hautstanzen  
Tissue Punches  
Mucotomi Punches  
Bisturí circular para tejido  
Bistouri circulaire pour tissue

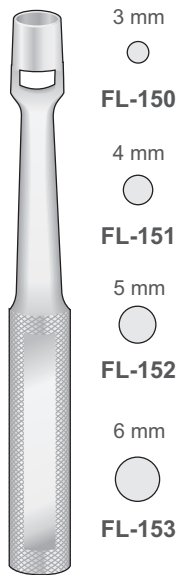

KEYES  
FL-150/FL-153  
100 mm

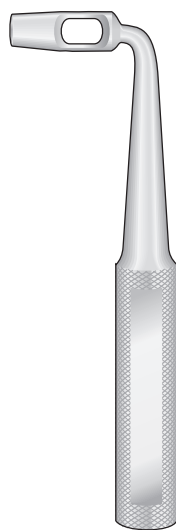

KEYES  
FL-155/FL-159  
90 mm

Implant Graduierung  
Implant depth gauge with ball end  
Sonda per controllare la profondità del sito  
Sonda para controlar la profundidad

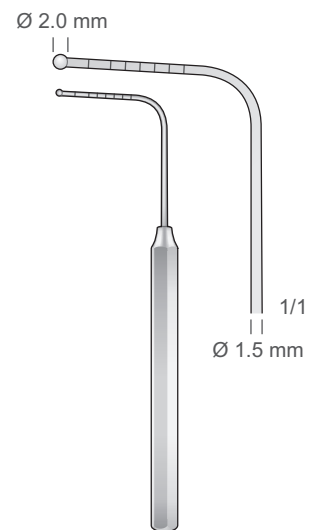

GA-60  
100 mm



## Implantology Instruments

Implantologie Instrumente  
Strumenti per implantologia  
Instrumentos para Implantología  
Instruments pour Implantologie



**PELTON-CRANE  
TS-40**  
Connection Piece  
int. Ø 7.5 mm  
ext. Ø 10.0 mm  
75 mm

Schalen  
Bowl  
Ciotola  
Cuenco  
Bacinella

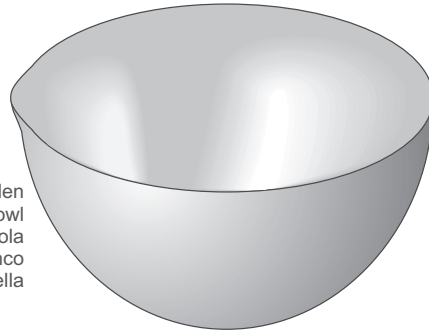

**CS-01** Ø 40 mm, 15 cc - 0.5 oz  
**CS-02** Ø 60 mm, 75 cc - 2.5 oz  
**CS-03** Ø 80 mm, 225 cc - 7.5 oz  
**CS-04** Ø 100 mm, 325 cc - 11 oz  
**CS-05** Ø 120 mm, 500 cc - 17 oz  
**CS-06** Ø 150 mm, 600 cc - 20 oz

inox Stainless Steel



**SS-65**  
Ø 35x35 mm  
depth 15 mm  
5cc - 0.17oz

Knochenschale  
Bone Well  
Bacinella per osso  
Cubeta para hueso  
Cuvette à os

Amalgambecher  
Amalgam Well  
Mortajo per amalgama  
Recipiente para amalgama  
Gobelet pour amalgame

Absaugkanülen für Knochen mit Filter  
Suction tube for bone with filter  
Cannule d'aspiration con trattenuta osso con filtro  
Cánulas aspiradoras para hueso con filtro  
Canule d'aspiration pour os avec filtre

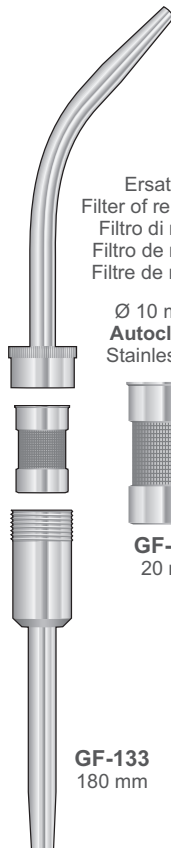

Ersatzfilter  
Filter of replacement  
Filtro di ricambio  
Filtro de recambio  
Filtre de rechange

Ø 10 mm int.  
**Autoclavable**  
Stainless Steel

**GF-134**  
20 mm

**GF-133**  
180 mm

Membranplatzierungsinstrumente  
Membrane Placement Instruments  
Strumenti per posizionare membrana  
Instrumentos para colocar membranas  
Instruments pour application de membrane

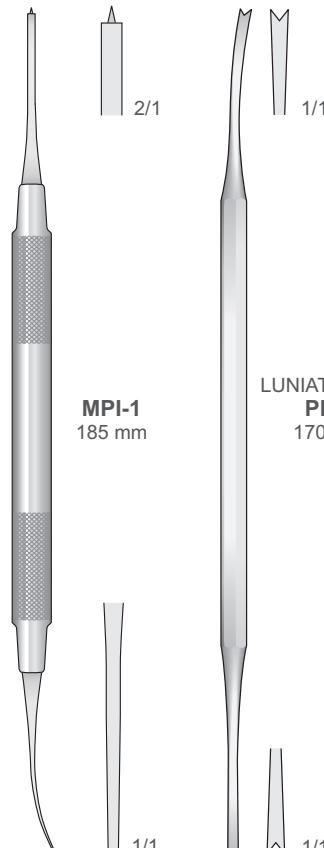

**MPI-1**  
185 mm

**LUNIATSCHEK  
PF-6**  
170 mm

Aufbring Instrument für Knochenmaterial  
Applicator for bone material  
Aplicatore per materiale osseo  
Cucharillas para material osseo  
Applicateur pour matière osseuse

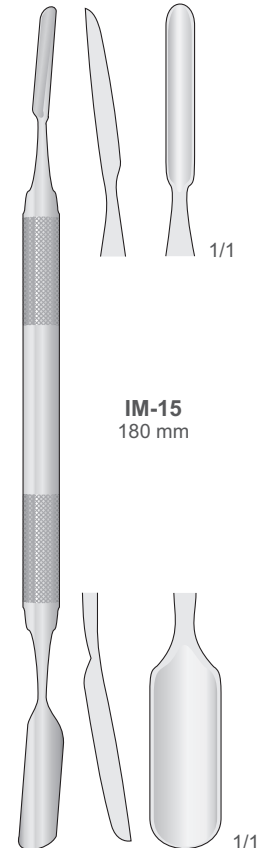

**IM-15**  
180 mm

## Bone Mills and Syringes

Knochenmühlen - und spritzen  
Macina e siringhe per osso  
Molinos y jeringas para hueso  
Moulins et seringues à os

## Implantology

Implantologie  
Implantologie  
Implantologia  
Implantologiya

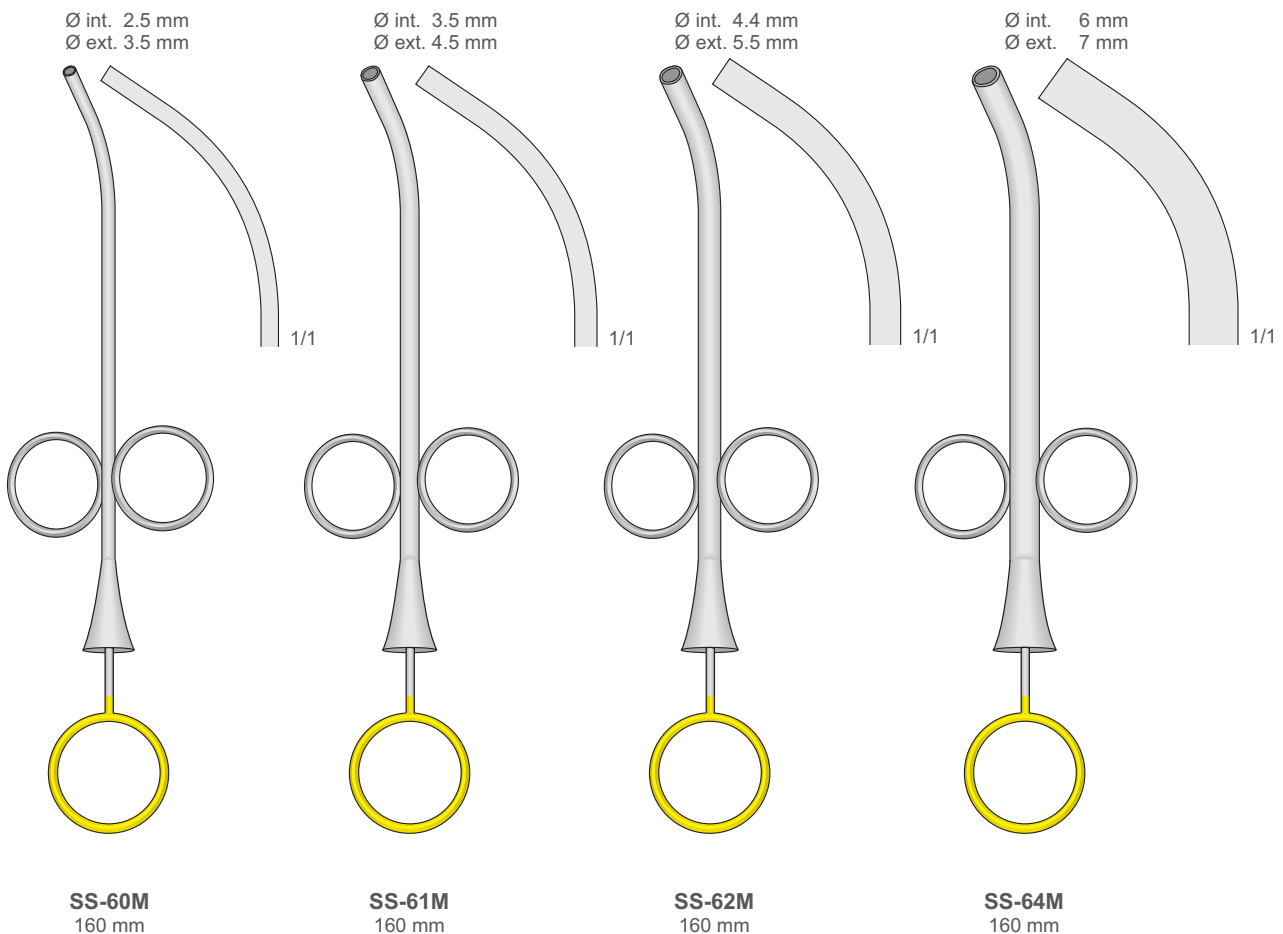
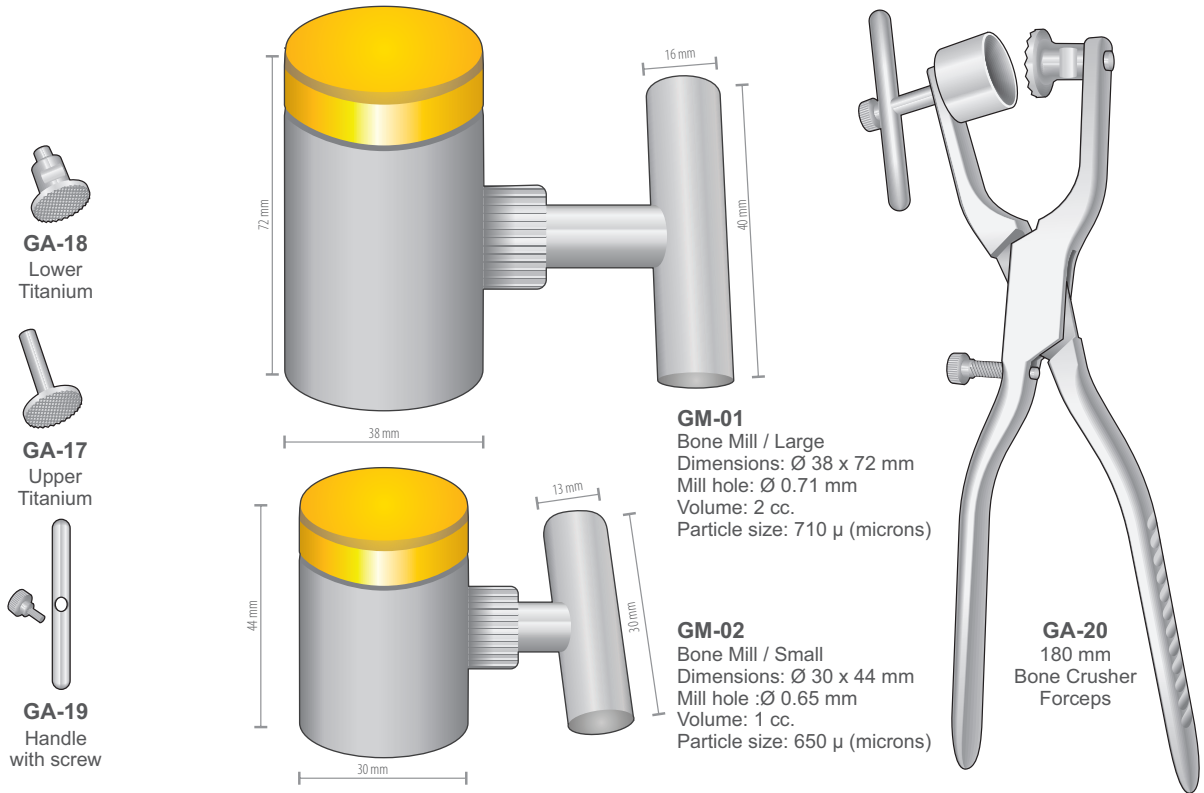

## Bone Tampers - Bone Grafting Packers

Knochenstopfer  
 Compattatore per osso  
 Compactador para hueso  
 Compacteur à os

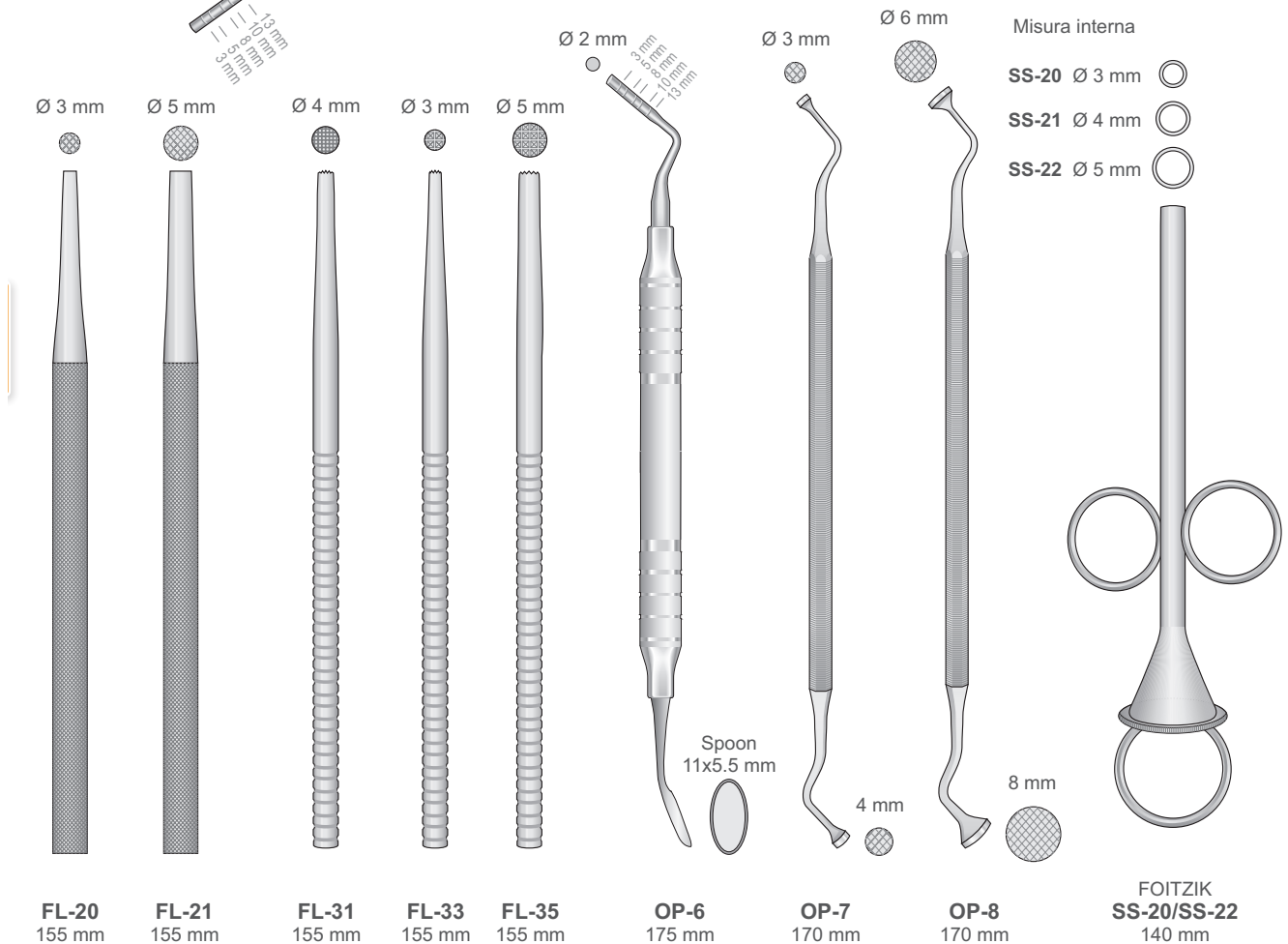
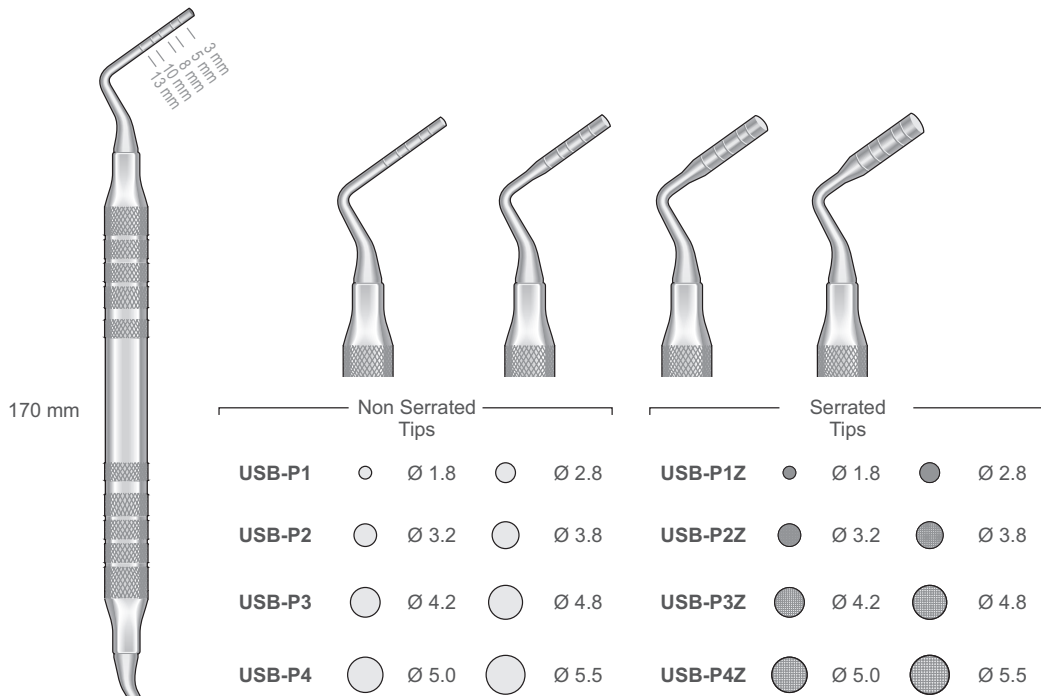

**Bone-Grafter. Stainless Steel**

Knochenschaber. Rostfrei Stahl  
 Grattini per osso. Inox  
 Raspador de hueso. Acero inoxidable  
 Racleur d'os. Acier inoxydable

**Implantology**

Implantologie  
 Implantologie  
 Implantologia  
 Implantologiya

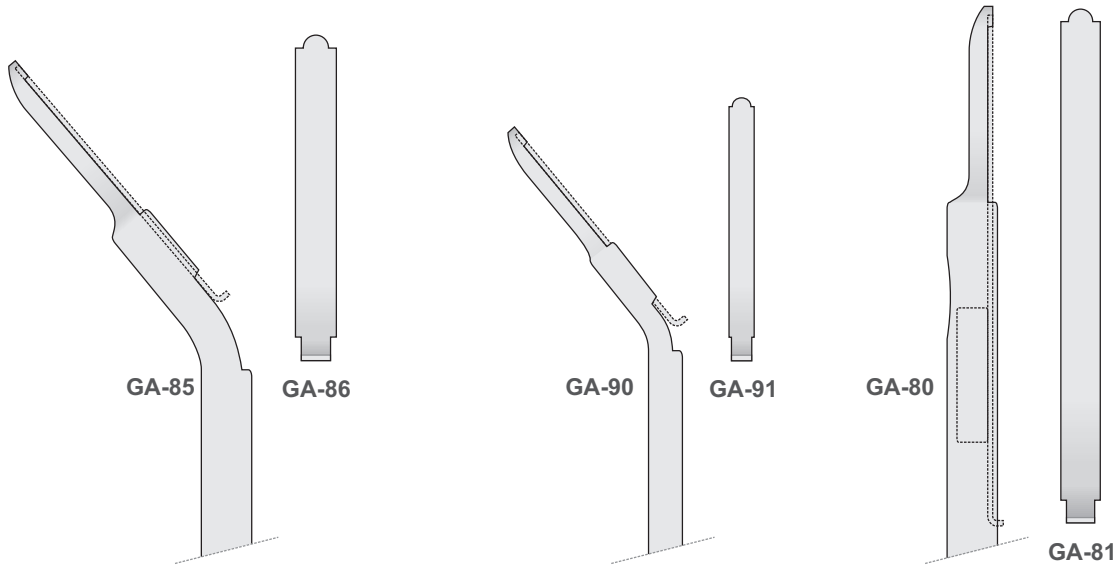

Knochenschaber mit Reibeklinge  
 Bone-Grafter with blade  
 Grattino con lama  
 Raspador de hueso con hoja  
 Racleur d'os avec lame

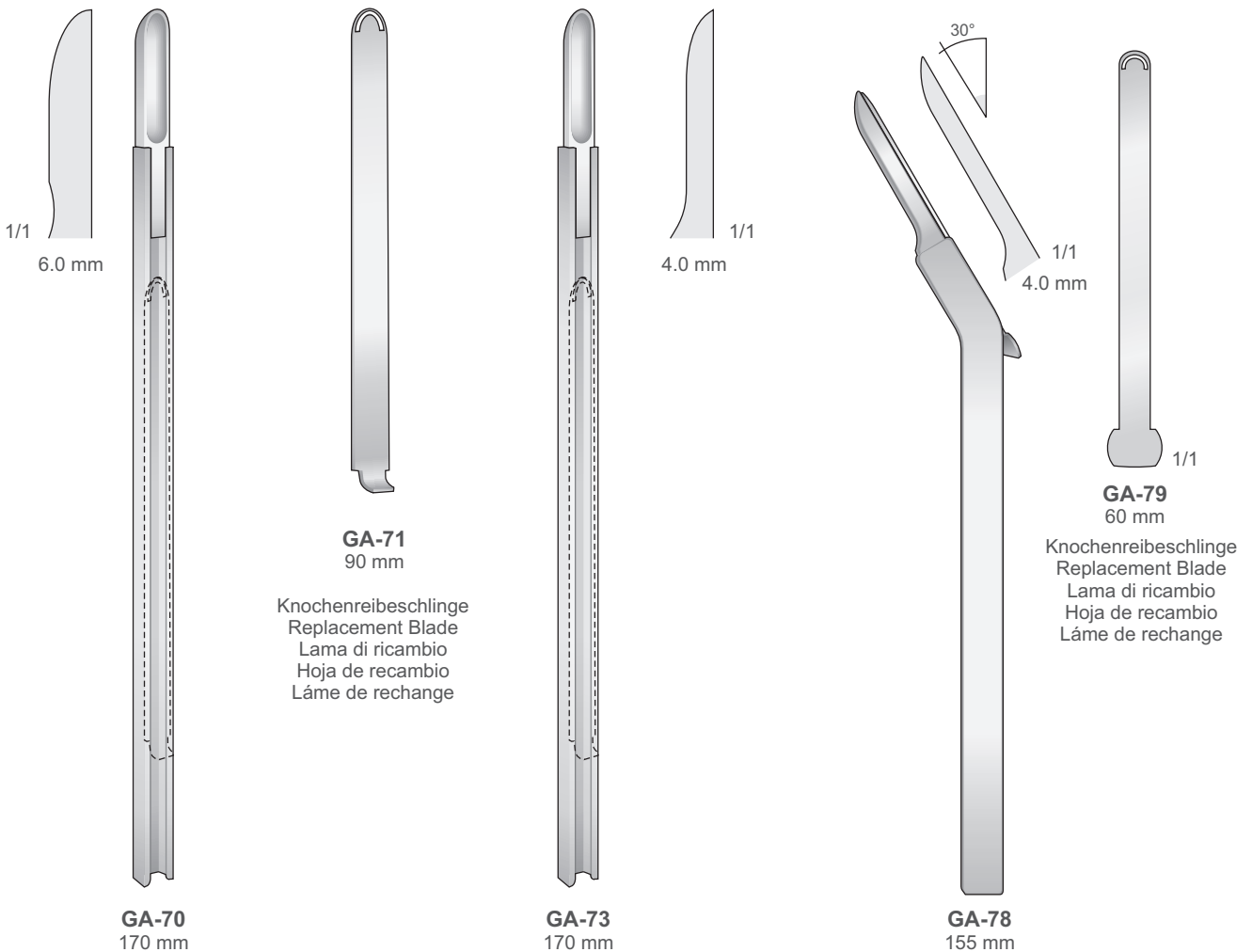

## Measuring instruments

Messinstrumente  
Strumenti per misura  
Instrumentos para medir  
Instruments à mesurer



**LS-09**  
200 mm



**LS-08**  
100 mm

Meßbereich: 0 - 20 mm  
Measuring range: 0 - 20 mm  
Campo di misura: 0 - 20 mm  
Alcance de medición: 0 - 20 mm  
Etendue de mesure: 0 - 20 mm

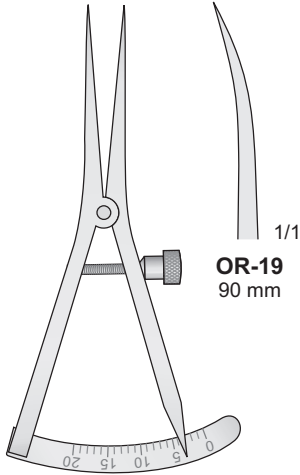

**OR-19**  
CASTROVIEJO  
90 mm

Meßbereich: 0 - 80 mm  
Measuring range: 0 - 80 mm  
Campo di misura: 0 - 80 mm  
Alcance de medición: 0 - 80 mm  
Etendue de mesure: 0 - 80 mm



**OR-40**  
125 mm

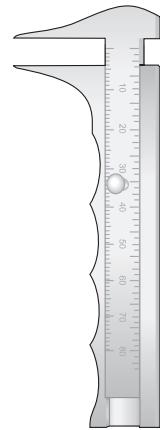

**OR-45**  
95 mm

0 - 40 mm  
Meßbereich / Measuring range / Campo di misura  
Alcance de medición / Etendue de mesure

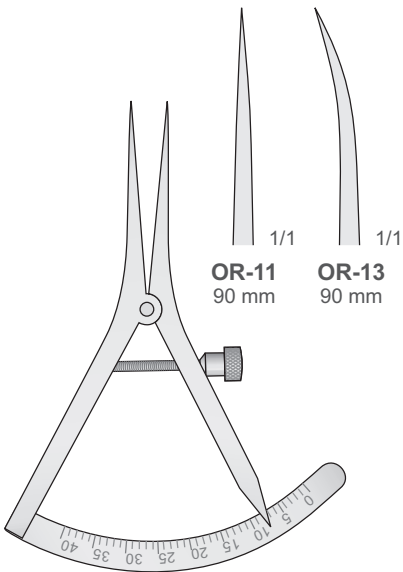

CASTROVIEJO  
**OR-11/OR-13**  
90 mm

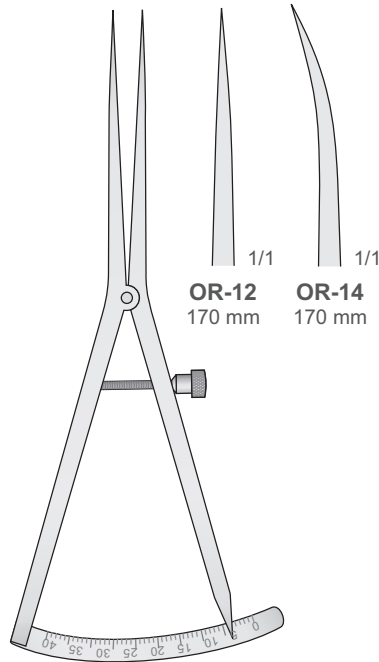

CASTROVIEJO  
**OR-12/OR-14**  
170 mm

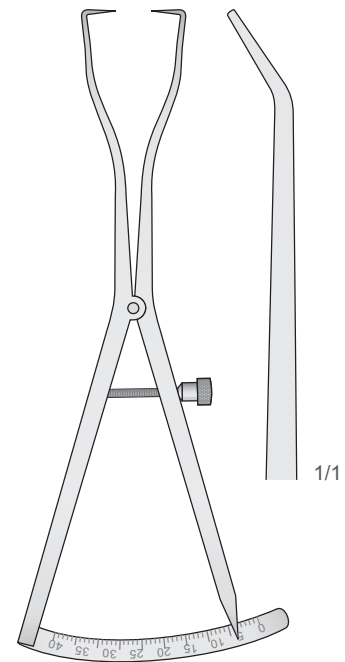

CASTROVIEJO  
**OR-18**  
170 mm

**Osteometer**

Osteometer  
Osteometro  
Osteometro  
Osteometer

**Implantology**

Implantologie  
Implantologie  
Implantologia  
Implantologiya

**TRIDIMENSIONAL IMPLANTOLOGY CALIPER**

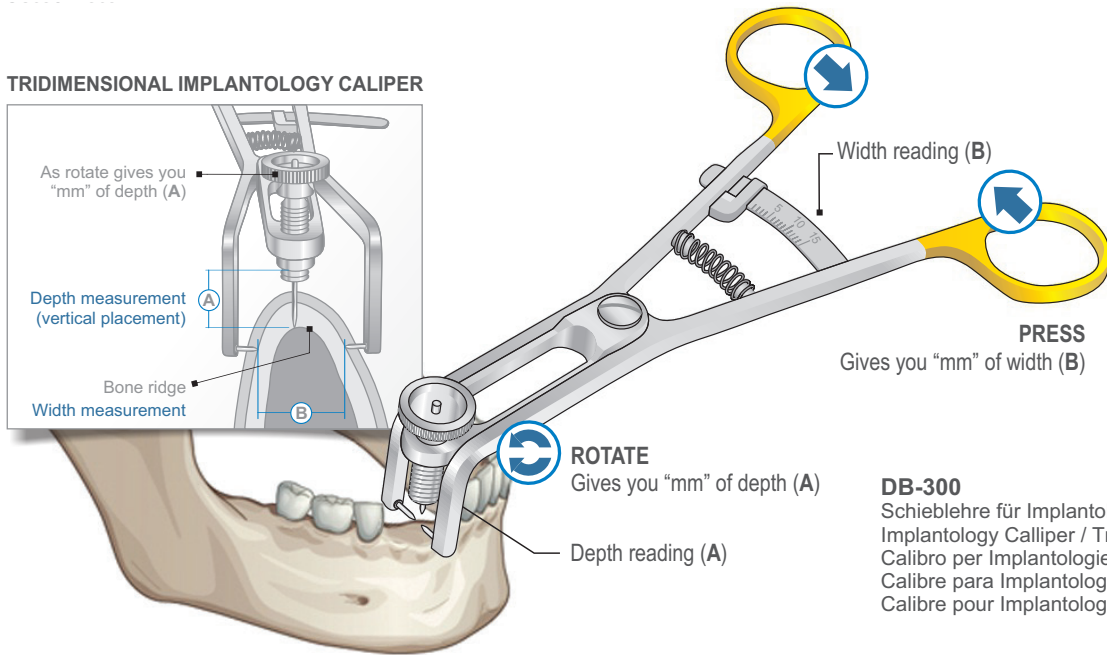
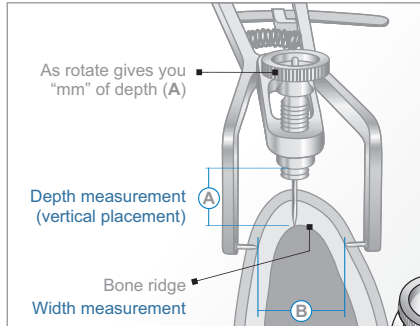

**DB-300**

Schieblehre für Implantologie / Drei-Dimensional  
Implantology Calliper / Tridimensional  
Calibro per Implantologie / Tridimensionale  
Calibre para Implantologia / Tridimensional  
Calibre pour Implantologie / Tridimensionnel

**BONE BLOCK CLAMP**

Bone Holding Clamps / Knochenhalteklammern / Daviers à os  
Pinzas de sujeción para hueso / Pinze per fissare l'osso

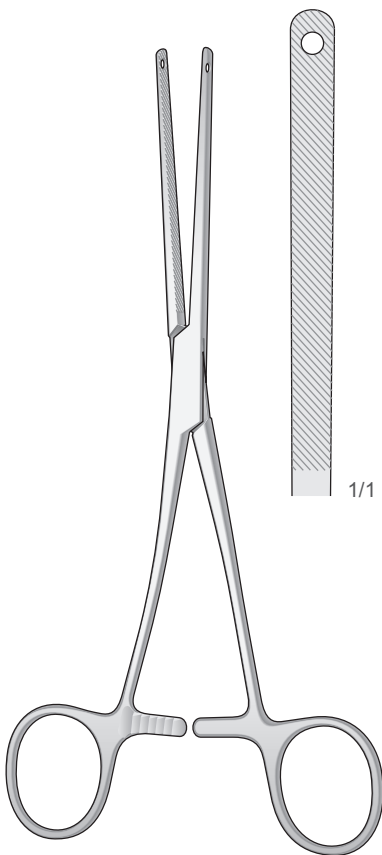

**P-340**  
220 mm

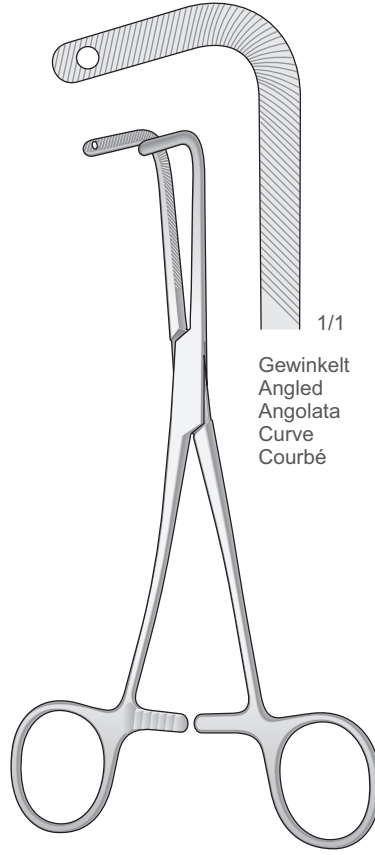

**P-341**  
200 mm

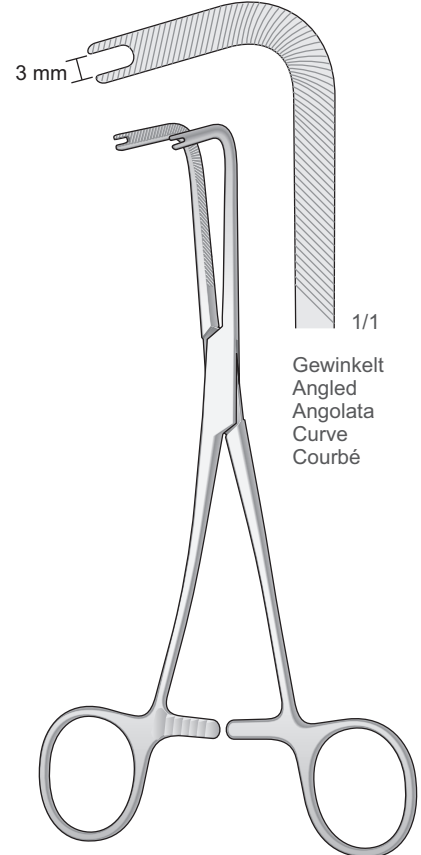

**P-342**  
200 mm

Gewinkelt  
Angled  
Angolata  
Curve  
Courbé

Gewinkelt  
Angled  
Angolata  
Curve  
Courbé

## Retractors - Bone Holding Forceps

Retraktoren - Knochenhaltezange

Divaricatori - Pinza per fissare l'osso

Separadores - Pinzas para sujeción para hueso

Écarteurs - Daviers à os

Tibia Wundspreizer  
Tibial and Iliac Retractor  
Divaricatore per tibia e cresta iliaca  
Separadores tibiales e iliacos  
Écarteur pour tibia e crête iliaque

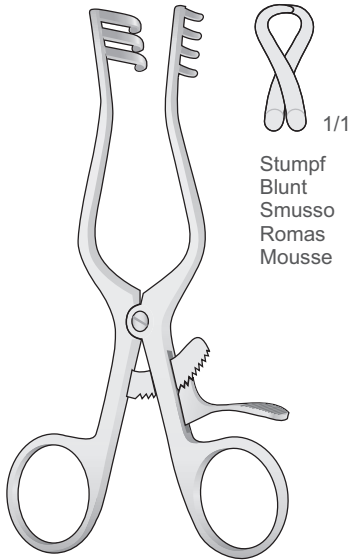

**WEITLANER**  
**BV-23**  
165 mm

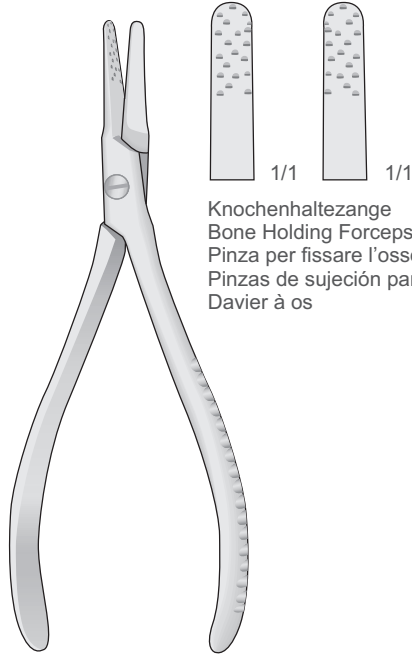

**RADOLF**  
**FO-159**  
135 mm

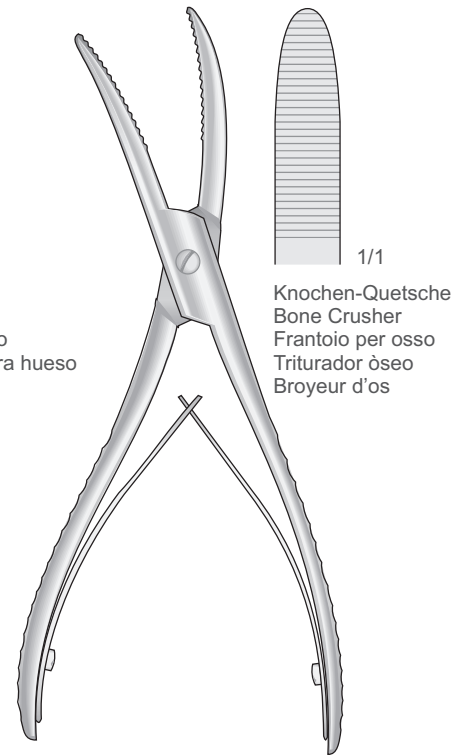

**WOLFF**  
**LX-113**  
180 mm

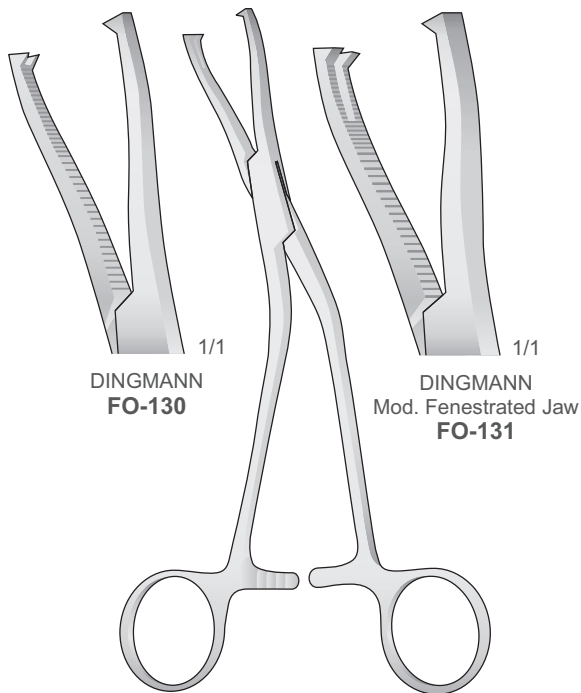

**DINGMANN**  
**FO-130**

**DINGMANN**  
Mod. Fenestrated Jaw  
**FO-131**

**DINGMANN**  
**FO-130/FO-131**  
190 mm

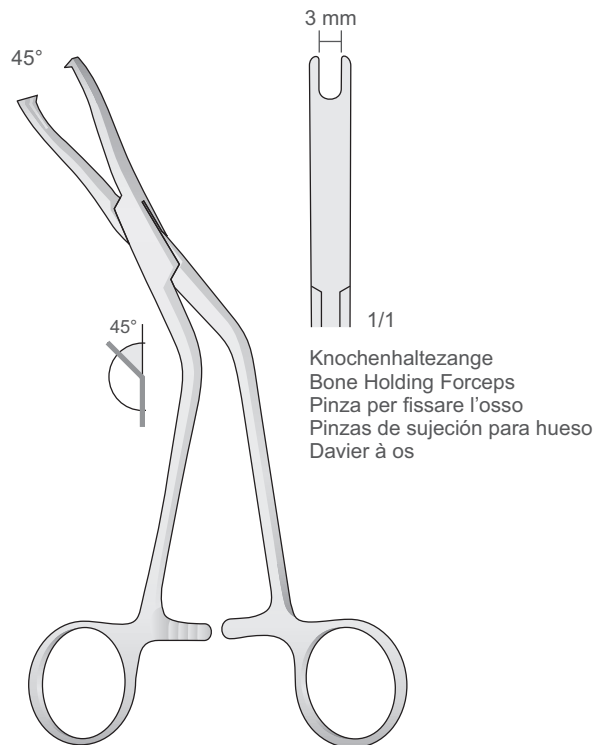

**DINGMANN - Mod. Fenestrated Jaw**  
**FO-131S**  
190 mm